

AWM
.K8369

Library
of the
University of Wisconsin

83-27

University of Wisconsin Library

Manuscript Theses

Unpublished theses submitted for the Master's and Doctor's degrees and deposited in the University of Wisconsin Library are open for inspection, but are to be used only with due regard to the rights of the authors. Bibliographical references may be noted, but passages may be copied only with the permission of the authors, and proper credit must be given in subsequent written or published work. Extensive copying or publication of the thesis in whole or in part requires also the consent of the Dean of the Graduate School of the University of Wisconsin.

This thesis by.....
has been used by the following persons, whose signatures attest their acceptance of the above restrictions.

A Library which borrows this thesis for use by its patrons is expected to secure the signature of each user.

NAME AND ADDRESS

DATE

AN INVESTIGATION
OF
THE FATIGUE OF METALS

BY
HERBERT FISHER MOORE
JESSE BENJAMIN KOMMERS

A THESIS SUBMITTED FOR
THE DEGREE OF MECHANICAL ENGINEER

University of Wisconsin

1922

APPROVAL

The foregoing thesis is hereby approved as a creditable study of an engineering subject, carried out and presented in a manner sufficiently satisfactory to warrant its acceptance as a prerequisite to the degree for which it has been submitted. It is to be understood that by this approval the undersigned does not necessarily endorse or approve any statement made, opinions expressed, or conclusions drawn therein, but approves the thesis only for the purpose for which it is submitted.

NAME

J. L. Larson

TITLE

Prof. Steam & Gas Engineering

NAME

E. R. Maurer

TITLE

Professor of Mechanics

NAME

Edward Bennett

TITLE

Prof of Electrical Engineering

UNIVERSITY OF ILLINOIS BULLETIN

ISSUED WEEKLY

Oct. 24, 1921

Vol. XIX

No. 8

Entered as second-class matter December 11, 1912, at the post office at Urbana, Illinois, under the Act of August 24, 1912. Acceptance for mailing at the special rate of postage provided for in section 1103, Act of October 3, 1917, authorized July 31, 1918.]

AN INVESTIGATION OF THE FATIGUE OF METALS

BY

H. F. MOORE

AND

J. B. KOMMERS

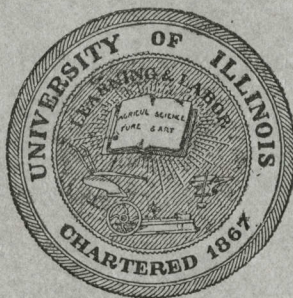

BULLETIN No. 124

ENGINEERING EXPERIMENT STATION

PUBLISHED BY THE UNIVERSITY OF ILLINOIS, URBANA

PRICE: NINETY-FIVE CENTS

EUROPEAN AGENT

CHAPMAN & HALL, LTD., LONDON

THE Engineering Experiment Station was established by act of the Board of Trustees of the University of Illinois on December 8, 1903. It is the purpose of the Station to conduct investigations and make studies of importance to the engineering, manufacturing, railway, mining, and other industrial interests of the State.

The management of the Engineering Experiment Station is vested in an Executive Staff composed of the Director and his Assistant, the Heads of the several Departments in the College of Engineering, and the Professor of Industrial Chemistry. This Staff is responsible for the establishment of general policies governing the work of the Station, including the approval of material for publication. All members of the teaching staff of the College are encouraged to engage in scientific research, either directly or in coöperation with the Research Corps composed of full-time research assistants, research graduate assistants, and special investigators.

To render the results of its scientific investigations available to the public, the Engineering Experiment Station publishes and distributes a series of bulletins. Occasionally it publishes circulars of timely interest, presenting information of importance, compiled from various sources which may not readily be accessible to the clientele of the Station.

The volume and number at the top of the front cover page are merely arbitrary numbers and refer to the general publications of the University. *Either above the title or below the seal* is given the number of the Engineering Experiment Station bulletin or circular which should be used in referring to these publications.

For copies of bulletins or circulars or for other information address

THE ENGINEERING EXPERIMENT STATION,
UNIVERSITY OF ILLINOIS,
URBANA, ILLINOIS.

UNIVERSITY OF ILLINOIS
ENGINEERING EXPERIMENT STATION

BULLETIN No. 124

Oct., 1921

AN INVESTIGATION OF THE FATIGUE OF METALS

A REPORT OF THE INVESTIGATION

CONDUCTED BY

THE ENGINEERING EXPERIMENT STATION
UNIVERSITY OF ILLINOIS

IN COÖPERATION WITH

THE NATIONAL RESEARCH COUNCIL
THE ENGINEERING FOUNDATION
THE GENERAL ELECTRIC COMPANY

BY

H. F. MOORE

RESEARCH PROFESSOR OF ENGINEERING MATERIALS
IN CHARGE, INVESTIGATION OF THE FATIGUE OF METALS

AND

J. B. KOMMERS

RESEARCH ASSOCIATE PROFESSOR OF ENGINEERING MATERIALS
ENGINEER OF TESTS, INVESTIGATION OF THE FATIGUE OF METALS

ENGINEERING EXPERIMENT STATION

PUBLISHED BY THE UNIVERSITY OF ILLINOIS, URBANA

412196

OCT 12 1934

AWM

K8364

CONTENTS

	PAGE
I. INTRODUCTION	9
1. Inception of the Investigation	9
2. Personnel of the Advisory Committee of the Division of Engineering of the National Research Council	10
3. Outline of Investigation	11
4. Organization of Test Party	12
5. Acknowledgments	12
II. MATERIALS, TESTS, TESTING APPARATUS, AND TEST SPECI- MENS	14
6. Materials	14
7. Tests	19
8. Testing Machines and Apparatus	20
9. Test Specimens	43
10. Finish of Specimens	48
11. Numbering of Specimens	48
12. Procedure in Tests—Accuracy and Sensitiveness	49
III. TEST DATA AND RESULTS	54
13. Summary of Test Data and Results	54
IV. DISCUSSION OF RESULTS	90
14. Endurance Limit	90
15. Some Factors Influencing Endurance Limit	93
16. Relation of Static Strength to Endurance Limit	95
17. Correlation of Results of Hardness Tests and of Impact Tests with Results of Reversed-Stress Tests	100
18. Accelerated Methods of Determining Endurance Limit	102

19.	Effect of Cold Work on Fatigue Strength	104
20.	Effect of Shape of Specimen on Endurance	105
21.	Effect of Surface Finish	108
22.	Effect of Overstress	112
23.	Theories of Nature of Fatigue of Metals	114
V. "RISE OF TEMPERATURE" METHOD OF DETERMINING EN- DURANCE LIMIT, BY W. J. PUTNAM AND J. W. HARSCH 119		
24.	Thermal Phenomena in Metals Under Stress	119
25.	Apparatus	120
26.	Materials	123
27.	Tests	123
28.	Results and Discussion	124
VI. SUBJECTS FOR FURTHER INVESTIGATION 128		
29.	Effect of Repetition of Stress Not Reversed	128
30.	Tests on Other Ferrous Metals	128
31.	Tests on Non-Ferrous Metals	128
32.	Effect of Heat Treatment	129
33.	Direct Tension-Compression Tests	129
34.	Strength Under Reversed Shearing Stress	129
35.	Study of Mechanism of Fatigue Failure	130
36.	Effect of Repeated Understressing	130
37.	Strength of Cast Metal Under Repeated Stress	130
38.	Repair by Heat Treatment of Structural Damage Due to Repeated Stress	131
VII. CONCLUSIONS 132		
39.	Summary of Conclusions	132
APPENDIX A 135		
Comparison of Endurance Tests Beyond Yield Point With Endurance Tests Within Yield Point 135		

CONTENTS (CONTINUED)

5

APPENDIX B	141
Fatigue Phenomena in Metals	141
APPENDIX C	160
Glossary of Technical Terms	160
APPENDIX D	168
Bibliography	168

LIST OF FIGURES

NO.	PAGE
1. Micrographs of the Steels Tested	15
2. Marking Diagrams for Specimens	18
3. Rotating-Beam Testing Machine (Farmer)	21
4. Diagram of Rotating-Beam Testing Machine (Farmer)	23
5. Rotating-Beam Testing Machine (Wisconsin)	25
6. Diagram of Rotating-Beam Testing Machine (Wisconsin)	27
7. Upton-Lewis Reversed-Bending Testing Machine	29
8. Diagram of Upton-Lewis Reversed-Bending Testing Machine	28
9. Olsen-Foster Reversed-Torsion Testing Machine	30
10. Diagram of Olsen-Foster Reversed-Torsion Testing Machine	28
11. Charpy Single-Blow Impact Testing Machine	33
12. Tension Test Attachment for Charpy Impact Testing Machine	35
13. Repeated-Impact Testing Machine	37
14. Diagram of Repeated-Impact Testing Machine	36
15. Apparatus for Magnetic Tests	38
16. Detrusion Indicator for Torsion Tests	40
17. Heat-Treating Equipment	41
18. Test Specimens	44
19. Test Specimens	45
20. Variation of Stress Along Farmer-Type Test Specimen	46
21. Representative Stress-Strain Diagrams for Tension Tests	51
22. Representative Stress-Strain Diagrams for Compression Tests	62
23. Representative Stress-Strain Diagrams for Torsion Tests	63
24. <i>S-N</i> Diagrams for 0.93 Carbon Steel and for 1.20 Carbon Steel, Rotating-Beam Tests	64
25. <i>S-N</i> Diagrams for Chrome-Nickel Steel and for 0.37 Carbon Steel, Rotating-Beam Tests	65
26. <i>S-N</i> Diagrams for 0.52 Carbon Steel, 0.49 Carbon Steel, 0.02 Carbon Steel, and 3.5 Nickel Steel, Rotating-Beam Tests	66
27. <i>S-N</i> Diagrams for Hot-Rolled Steel and for Cold-Drawn Steel, Rotating-Beam Tests	67
28. <i>S-N</i> Diagrams Showing Effect of Shape of Specimen, Rotating-Beam Tests	68
29. <i>S-N</i> Diagrams Showing Effect of Surface Finish, Rotating-Beam Tests	69

30.	<i>S-N</i> Diagrams Showing Effect of Overstress, 0.49 Carbon Steel, Rotating-Beam Tests	70
31.	<i>S-N</i> Diagrams Showing Effect of Overstress, 1.20 Carbon Steel, Rotating-Beam Tests	71
32.	<i>S-N</i> Diagrams, Upton-Lewis Tests, 0.93 Carbon Steel, 1.20 Carbon Steel, 0.49 Carbon Steel, and 0.02 Carbon Steel	72
33.	<i>S-N</i> Diagrams, Upton-Lewis Tests, 0.52 Carbon Steel, 0.37 Carbon Steel, and Chrome-Nickel Steel; Tests on Wisconsin Machine, Chrome-Nickel Steel	73
34.	<i>S-N</i> Diagrams, Olsen-Foster Tests, 0.93 Carbon Steel, 0.02 Carbon Steel, and 0.49 Carbon Steel	74
35.	<i>S-N</i> Diagrams, Olsen-Foster Tests, 0.37 Carbon Steel and Chrome-Nickel Steel	75
36.	Various Methods of Plotting <i>S-N</i> Diagrams	91
37.	Comparison of Endurance Limits With Temperature Endurance Limits, Proportional Limits, and Ultimate Tensile Strengths	96
38.	Comparison of Endurance Limits With Brinell Hardness, Charpy Impact-Bending Values, Charpy Impact-Tension Values, and Repeated-Impact Values	101
39.	Specimens for Study of Effect of Shape on Endurance Limit	107
40.	Micrographs of Surface Finish	109
41.	Micrograph of Surface of Rouge-Finished Specimen	110
42.	Machine for "Rise of Temperature" Tests	121
43.	Representative Diagrams for "Rise of Temperature" Tests	125
44.	<i>S-N</i> and <i>D-N</i> Diagrams for Tests on Wisconsin Rotating-Beam Testing Machine	139
45.	Diagrams of Typical Repeated-Stress Testing Machines	145
46.	Micrograph Showing Slip Lines in Iron	147

LIST OF TABLES

NO.	PAGE
1. Chemical Analyses of Steels Tested	14
2. Heat Treatments of Steels Tested	17
3. Results of Tension Tests	55-56
4. Results of Compression Tests and Torsion Tests	57
5. Results of Hardness Tests, Impact Tests, Francke Tests, and Reversed-Stress Tests	58-59
6. Representative Summary Sheet; Tests of Chrome-Nickel Steel, Treatment A	60-61
7. <i>S-N</i> Results for Reversed-Stress Tests	76-89
8. Comparison of Endurance Limit Found by Rotating-Beam Tests With That Found by "Rise of Temperature" Tests	124
9. Chemical Analyses of Steels for Special Series of Tests in the Wisconsin Rotating-Beam Testing Machine	136
10. Results of Tension Tests of Steels for Special Series of Tests in the Wisconsin Rotating-Beam Testing Machine	137
11. Comparison of Computed Values and Actual Values of Stress for Special Series of Tests in the Wisconsin Rotating-Beam Testing Machine	140
12. Approximate Service Required of Various Members of Structures and Machines Subjected to Repeated Stress	143

AN INVESTIGATION OF THE FATIGUE OF METALS

I. INTRODUCTION

1. *Inception of the Investigation.*—For three-quarters of a century the problem of the strength of metals under stresses repeated many times has engaged the attention of engineers. It has been recognized that loads which cause no apparent damage when applied a few times to a machine or structural part may cause failure if applied many times. Various investigations of the phenomenon of failure under repeated stress* have been made and the name “fatigue of metals” has been given to it. The earliest extensive investigation, and the best known, is that of Wöhler, whose results were published in 1870.

During the world war the question of strength of airplane parts under repeated stress became of prime importance. A special phase of this problem was a study of the strength of parts made of cold-drawn steel, and a short series of experiments was made in the laboratories of the University of Illinois at the request of the National Research Council.† This problem and other problems of material under repeated stress, notably repeated stresses in welded ships, brought the whole subject of fatigue phenomena of metals to the attention of the National Research Council. The result was the organization of an investigation by the coöperation of the National Research Council Division of Engineering, Engineering Foundation, and the Engineering Experiment Station of the University of Illinois. Later the General Electric Company joined this group.

The National Research Council furnished an Advisory Committee to formulate general policies for the investigation. The Engineering Experiment Station provided a laboratory, the time of one member of its staff, and the use of much apparatus. A previous progress report of this investigation gave a general summary of the knowledge of fatigue phenomena of metals current at the time of the beginning of the investigation. This was published in “Mechanical Engineer-

* See Appendix C, which gives a glossary of technical terms used in this bulletin.

† Moore and Putnam, Am. Inst. of Mining and Metall. Engrs., Bul. 146, p. 401, Feb., 1919.

ing" (the organ of the American Society of Mechanical Engineers), for September, 1919, and is reprinted in substance as Appendix B of this bulletin.*

The investigation was financed, first, by Engineering Foundation from the fund given by Mr. Ambrose Swasey of Cleveland, Ohio. This grant was sufficient to permit the organization of a test party, the purchase of many pieces of apparatus, the preparation of a large number of specimens, and the maintenance of the laboratory for a term of two years. In 1920 the General Electric Company contributed an equal sum for investigations along certain lines of special interest to them, without any restrictions as to the free publication of the results. This contribution made possible the enlargement of the test party and the purchase of more equipment. The lines of investigation desired by the General Electric Company follow so closely the lines of the original investigation that, in compiling this report, data and results have been taken from both parts, but mainly from the original investigation financed by Engineering Foundation, as, owing to the fact that this part of the investigation had been in progress for a longer time, more material was available from this source.

2. *Personnel of the Advisory Committee of the Division of Engineering of the National Research Council.*—The personnel of the Advisory Committee is given below:

O. H. BASQUIN, Professor of Applied Mechanics, Northwestern University;

F. P. GILLIGAN, Secretary-Treasurer, Henry Souther Engineering Company;

HENRY M. HOWE, Metallurgist, Bedford Hills, New York;

ZAY JEFFRIES, Director of the Cleveland Section of the Research Bureau, Aluminum Company of America;

T. R. LAWSON, Professor of Rational and Applied Mechanics, Rensselaer Polytechnic Institute;

J. A. MATHEWS, President, Crucible Steel Company of America;

*For a more detailed account of previous investigations of the strength of materials under repeated stress see:

Unwin, W. C. "The Testing of the Materials of Construction," Chap. XVI, 1910.

Withey and Aston, "Johnson's Materials of Construction," Fifth Edition, Chap. XXVIII.

JOHN H. NELSON, Chief Metallurgist, Wyman-Gordon Company;

W. E. RUDER, Metallurgist, Research Laboratory, General Electric Company;

H. L. WHITTEMORE, Chief of Section of General Physical Testing, U. S. Bureau of Standards;

LEONARD WALDO, Consulting Engineer, New York City;

H. F. MOORE, Research Professor of Engineering Materials, University of Illinois, Chairman.

In connection with the work of the Advisory Committee there have been organized two sub-committees: first, a sub-committee on Heat Treatment of Specimens, J. H. NELSON, Chairman (resigned October 22, 1920), W. E. RUDER, Chairman (since October 30, 1920), and F. P. GILLIGAN; and second, a sub-committee on Statistics, T. R. LAWSON, Chairman, LEONARD WALDO, and H. L. WHITTEMORE.

3. *Outline of Investigation.*—At a meeting held February 19, 1920, the Advisory Committee planned reconnaissance tests of materials well scattered over the field of ferrous metals, in most cases studying two or more distinct heat treatments for each metal. It was decided not to enter the field of non-ferrous metals at this time.

For each heat treatment of each steel tested it was planned to make a series of tests of specimens under reversed bending stress, using various stresses, until an "endurance" of 100 000 000 reversals was reached; to make corresponding static tests in tension, compression, and shear (torsion); and to make various auxiliary tests, including hardness tests and impact tests.

It was planned to use magnetic analysis for examining the homogeneity of the material tested, and to study various accelerated tests for resistance to repeated stress in order to determine their reliability.

The main purpose of this first stage of the investigation was to determine whether for ferrous metals there exists any clearly defined relation between the static properties (elastic limit, yield point, ultimate tensile strength, elongation, reduction of area, hardness, etc.) and ability to resist reversed stress.

When later the General Electric Company became a party to the investigation there was added to this program the study of the

effect of range of stress (stress partially reversed or repeated but not reversed, as well as stress completely reversed) upon the strength of ferrous metals under repeated stress. Work on this phase of the investigation has not passed the preliminary stage.

4. *Organization of Test Party.*—The test party was organized as follows. The chairman of the Advisory Committee, H. F. MOORE, who was also a member of the technical staff of the Engineering Experiment Station, was in general charge. The University allowed him to give nearly all his time to this work. An engineer of tests, J. B. KOMMERS, was in immediate charge of the work of the test party. Two test assistants carried on the routine work. Two mechanics prepared specimens and repaired and built auxiliary parts for apparatus, and a clerk gave half her time to the office work. The professor in charge of the metallographic laboratory in the Department of Chemistry gave some time to the metallographic features. Certain students of marked ability were allowed to take thesis work in connection with the investigation.

5. *Acknowledgments.*—The Investigation of Fatigue of Metals was made a part of the research work of the Department of Theoretical and Applied Mechanics, and was carried on under the general administrative direction of the head of the department, PROFESSOR A. N. TALBOT.

DR. HENRY M. HOWE, while serving as Chairman of the Engineering Division of the National Research Council, took an active interest in the fatigue phenomena in metals and it was largely owing to his suggestion, activities, and influence that this extensive investigation was made possible.

Acknowledgment is due the following individuals, firms, and institutions:

WYMAN-GORDON COMPANY, Worcester, Massachusetts, manufacturers of drop forgings, for assistance in the work of heat treatment of certain steels;

THE UNIVERSITY OF WISCONSIN, for the loan of a testing machine, and for permission to use certain test data in connection with Appendix A of this bulletin;

THE AMERICAN SOCIETY OF MECHANICAL ENGINEERS, for permission to reprint the Progress Report, Appendix B;

THE ILLINOIS STEEL COMPANY, Chicago, Illinois,

THE JOHN A. ROEBLINGS SONS COMPANY, Trenton, New Jersey,

THE HALCOMB STEEL COMPANY, Syracuse, New York,

THE STANDARD STEEL COMPANY, Philadelphia, Pennsylvania,

THE CARNEGIE STEEL COMPANY, Pittsburgh, Pennsylvania

THE GENERAL ELECTRIC COMPANY, Schenectady, New York, and THE MIDVALE STEEL AND ORDNANCE COMPANY, Philadelphia, Pennsylvania, for steel supplied for the investigation;

THE AMERICAN ROLLING MILLS COMPANY, for a supply of Armco iron (in this bulletin this material is designated as 0.02 carbon steel);

MR. W. J. FRANCKE of New Brunswick, New Jersey, for a number of special flexure tests upon various types of steel, and for depositing one of his special flexure testing machines;

DR. CHARLES W. BURROWS, Grasmere, Borough of Richmond, New York City, for permission to use his patented method of magnetic analysis for detecting flaws in steel;

The Physics Department and the Chemistry Department of THE UNIVERSITY OF ILLINOIS, for the loan of apparatus and for the use of rooms in which special tests were made.

The work of the following members of the test party is gratefully acknowledged:

PROFESSOR D. A. McFARLAND and PROFESSOR W. S. PUTNAM of the Department of Chemistry, for assistance in metallographic work;

F. H. FISH, F. M. HOWELL, F. M. POST, J. W. HARSCH, and PROFESSOR W. J. PUTNAM.

The following students in mechanical engineering of the 1921 senior class have taken thesis work in connection with this investigation, and their work has been of no small value:

MESSRS. R. F. PACKARD and MARTIN FRISCH, subject, "The Effect of Over-Stress on Subsequent Resistance to Repeated Stress"; GEORGE R. CASKEY, subject, "The Effect of Surface Finish on Resistance to Repeated Stress"; JOHN A. GOFF, subject, "The Effect of Radius of Fillet on Resistance to Repeated Stress."

II. MATERIALS, TESTS, TESTING APPARATUS, AND TEST SPECIMENS

6. *Materials*.—It having been decided to confine this preliminary investigation to ferrous metals, a series widely distributed among the varieties of steels in common use was selected. Table 1 gives the chemical analyses and reference numbers for the different metals tested.

TABLE 1
CHEMICAL ANALYSES OF STEELS TESTED

Steel No.	Furnished by	Material Furnished in	CONTENT, PER CENT						
			Carbon	Chromium	Nickel	Silicon	Manganese	Phosphorus	Sulphur
1	Illinois Steel Co.....	2×1 flats.....	1.20	0.19	0.25	0.021	0.021
3	John A. Roeblings Sons Co.....	Billets 4-in. square .	0.52	0.24	0.56	0.037	0.029
4	John A. Roeblings Sons Co.....	Billets 4-in. square .	0.37	0.16	0.58	0.032	0.035
5	Halcomb Steel Co.....	2×1 flats.....	0.24	0.87	3.33	0.15	0.37	0.019	0.025
6	Carnegie Steel Co. through Standard Steel Co.....	2× $\frac{7}{8}$ flats.....	0.93	0.03	0.38	0.017	0.045
7	Midvale Steel & Ord. Co. through General Electric Co.....	1-in. squares.....	0.41	0.18	3.41	0.25	0.75	0.020	0.020
9	American Rolling Mill Co.....	1-in. rounds.....	0.02	0.02	0.03	0.005	0.042
10	Inland Steel Co.....	$\frac{1}{2}$ -in. squares.....	0.49	0.12	0.46	0.017	0.029
50	J. T. Ryerson & Son (Cold-drawn screw stock).....	$\frac{7}{16}$ -in. rounds.....	0.20	0.03	0.67	0.025	0.090
51	Univ. of Ill. stock (hot-rolled reinforcing rod).....	$\frac{1}{2}$ -in. rounds.....	0.18	0.06	0.37	0.013	0.039

It was decided to use two or more heat treatments for most of the metals tested. The heat treatments used are shown in Table 2, and the resulting internal structures as shown by microscopic examination are given in Fig. 1.

Excepting materials 4, 5, 9, 50, and 51, all were first given a normalizing heat treatment to relieve any internal strain which might be present and to give a common basis for any other heat treatments.

All the steels which were heat treated were treated in the form of rectangular bars after being cut up according to the diagram

shown in Fig. 2, except the following: 0.37 carbon, sorbitic, treatment A; 1.20 carbon, normalized; 1.20 carbon, sorbitic; and 0.93 carbon, troostitic. These steels were machined somewhat oversize, then heat treated, and later finished to size.

TABLE 2
HEAT TREATMENTS OF STEELS TESTED

No.	STEEL	HEAT TREATMENT
1	1.20 carbon, normalized	Heat to 1460° F.; hold 15 min.; cool in furnace (this anneals the steel so that it can be machined); then heat to 1580° F.; hold 15 min.; cool in furnace with door open.
	sorbitic	First anneal as above; then heat to 1470° F.; quench in oil; reheat to 860° F.; hold 30 min.; cool in air.
3	0.52 carbon, normalized	Heat to 1550° F.; hold 15 min.; cool in air.
	sorbitic	First normalize as above; then heat to 1450° F.; hold 15 min.; quench in water; reheat to 1200° F.; cool in air.
4	0.37 carbon, normalized	Heat to 1495° F.; hold 15 min.; cool in furnace with door open.
	sorbitic treatments A and B	This steel was <i>not</i> first normalized. Heat to 1550° F.; hold 15 min.; quench in water; reheat to 1050° F.; cool in air.
5	Chrome-nickel, treatment A	Steel received annealed. Heat to 1525° F.; quench in oil; reheat to 700° F.; quench in oil.
	treatment B	Steel received annealed. Heat to 1525° F.; hold for ½ hour; quench in oil. Reheat to 1450° F.; quench in oil. Reheat to 1200° F.; hold for 1 hour; cool in furnace.
	treatment C	Steel received annealed. Heat to 1525° F.; hold for ½ hour; quench in oil. Reheat to 1450° F.; quench in oil. Reheat to 1200° F.; hold for 1 hour; quench in water.
6	0.93 carbon, normalized	Heat to 1600° F.; hold 15 min.; cool in air.
	pearlitic	First normalize as above, then heat to 1450° F.; hold 15 min.; cool in furnace.
	sorbitic	First normalize as above; then heat to 1450° F.; hold 15 min.; quench in oil; reheat to 1200° F.; hold 30 min.; cool in air.
	troostitic	First normalize as above; then heat to 1450° F.; hold 15 min.; quench in oil; reheat to 850° F.; hold 30 min.; cool in air.
7	3.5 nickel, treatment B	Normalize by heating to 1525° F. and cooling in furnace; then heat to 1525° F.; quench in oil; reheat to 1210° F.; hold 2 hours; cool in furnace.
9	0.02 carbon	Tested as received.
10	0.49 carbon, normalized	Heat to 1700° F.; hold 20 min.; cool in air.
	sorbitic	First normalize as above; then heat to 1425° F.; quench in water; reheat to 1200° F.; cool in furnace.
50	Cold-drawn as received.	Heat to 1300° F.; hold for 15 min.; cool in furnace.
	annealed	Heat to 1550° F.; hold for 15 min.; cool in furnace.
51	0.18 carbon as received.	
	cold stretched	Reduced to diameter of 0.44 in.; then heat to 500° F.; cool in furnace.
	cold stretched	Reduced to diameter of 0.48 in.; then heat to 500° F.; cool in furnace.
	cold bent	Bent to an angle of 45° at the middle, straightened cold.

4A13 4A32
4C13 4C26

A	B	C	D	E
F	G	H	I	J
K	L	M	N	O
P	Q	R	S	T
U	V	W	X	Y

Farmer
Impact Bending

4C21 4C28

A	B	C	D
E	F	G	H
I	J	K	L
M	N	O	P

Reverse Torsion
Torsion
Tension

4C33

A	B	C	D				
E	F	G	H				
I	J	K	L	M	N	O	P

Impact Tension
Compression
Reverse Bending

4A19

A	B	C	D	E	F	G	H
I	J	K	L	M	N		
O	P	Q	R	S			
T							

Reverse Bending
Impact Bending

No. 4, 0.37 Carbon Sorbitic

4B13 4B0

A	B	C	D	E
F	G	H	I	J
K	L	M	N	O
P	Q	R	S	

Farmer

4B26

A	B	C	D
E	F	G	H
I	J	K	L
M	N	O	P

Reverse Torsion

No. 4, 0.37 Carbon Normalized

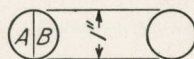

Farmer Other

No. 9, 0.02 Carbon

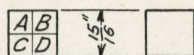

Farmer Other

No. 10, 0.49 Carbon

3B13 3B26 3C39

A	B	C	D	E
F	G	H	I	J
K	L	M	N	O
P	Q	R	S	
T	U	V	W	

3B39 3C26

A	B	C	D	E
F	G	H	I	J
K	L	M	N	
O	P	Q	R	

No. 3, 0.52 Carbon Normalized

3A13 3A26

A	B	C	D
E	F	G	H
I	J	K	L
M	N	O	P

3A39 3C13

A	B	C	D	E
F	G	H	I	J
K	L	M	N	
O	P	Q	R	

No. 3, 0.52 Carbon Sorbitic



Farmer Other

No. 6, 0.93 Carbon

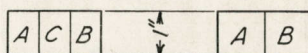

Farmer Other

No. 1, 1.20 Carbon



Farmer Other

No. 7, General Electric 3 1/2% Ni.



Treatment "A" Treatment "B-C"

No. 5, Chrome-Nickel

Fig. 2. MARKING DIAGRAMS FOR SPECIMENS

7. *Tests.*—Mechanical tests of metals may be divided into three groups: first, “static” tests, usually made on the ordinary tension-compression testing machine; second, repeated-stress tests, and third, impact tests. Static tests include torsion and flexure tests and Brinell hardness tests. Probably scleroscope hardness tests would also be classified with static tests.

The results of static tests indicate the resistance of a metal to the destructive action of a steady load or a load applied a few times. Static tests yield significant results concerning the suitability of material for buildings, tanks, and other structures, including most bridges.

The results of repeated-stress tests indicate the resistance of a metal to progressive failure under many repetitions of a given working load. Repeated-stress tests have not been thoroughly standardized, but would seem to yield significant results concerning the suitability of material for machine or structural parts which are to be subjected to many repetitions of loading when there is little danger of accidental heavy overload; springs, shafting, and car axles, for example.

The results of impact tests indicate the resisting power of material against shattering under sudden heavy overload. Impact tests would seem to yield significant results concerning the suitability of material for machine or structural parts which may be occasionally subjected to heavy overload, and which can still be used after some permanent distortion has taken place. Impact-resisting power seems to be a sort of insurance against complete collapse under sudden overload.

In this connection it may be noted that the strength-indicating results of static tests and the endurance limits given by repeated-stress tests are measured in the same units—pounds per square inch; the results of impact tests are measured in units of energy—foot-pounds or inch-pounds. It may be further noted that the results of an impact test are comparable with a measurement of the area under the complete stress-strain diagram for a static test, or, using a rough approximation, the results of an impact test are comparable with the product of ultimate strength and elongation given by a static test. The term *toughness* is sometimes used to indicate a combination of the static strength and the ductility, and the impact test may be said

to be the index of the toughness of a material. Again it may be noted that the strength-indicating results of static tests, and the results of repeated-stress tests indicate ability to withstand normal service conditions, while the results of impact tests—and the results of static tests which measure ductility—indicate ability to withstand occasional overload without complete shattering failure.

The principal series of tests in this investigation are the reversed-stress tests performed on the various materials. These tests are discussed in further detail in Section 8. As the problem of determining relations existing between strength under repeated stress and strength under ordinary static tests was the primary problem of the investigation, careful tests on ordinary testing machines formed another series of tests of prime importance. These tests included tension tests, compression tests, and torsion tests, the last named giving values for shearing strength.

In addition to the regular static tests, a limited number of special flexure tests were made, some in the laboratories of the University of Illinois and some at the laboratory of Mr. W. J. Francke of New Brunswick, New Jersey.

Brinell and scleroscope hardness tests were made. Charpy impact tests were made, both on notched bars in bending and on tension specimens.

Magnetic tests for homogeneity were made on the bars used for repeated-stress specimens for the rotating-beam machine before they were reduced at the center.

8. *Testing Machines and Apparatus.*—The rotating-beam type of testing machine was chosen for the basic series of repeated-stress tests. This machine has been used by many previous investigators, beginning with Wöhler in his historic series of tests. Fig. 3 is from a photograph of the machine used, and Fig. 4 shows a diagram of the machine.

In Fig. 3 and Fig. 4 the specimen, *A*, is in the form of a bar reduced in diameter at the middle of its length. It is held in ball bearings, *B*, *C*, *D*, and *E*, by means of draw-in collets (one collet is shown in detail at *F*). The specimen is driven by the shaft, *G*, operating through the flexible leather disc, *H*. Pulley *K* is driven by an electric motor. Load is applied by means of weights hung at *W*.

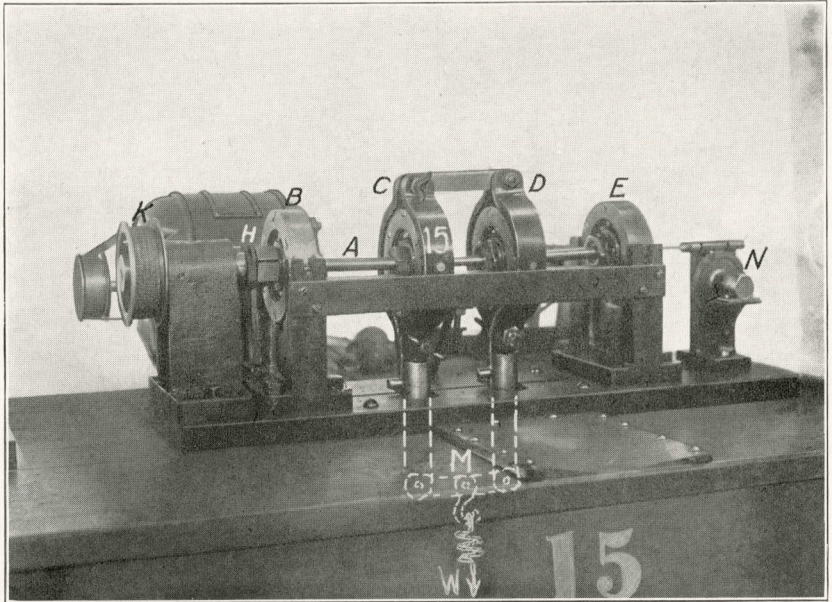

FIG. 3. ROTATING-BEAM TESTING MACHINE (FARMER)

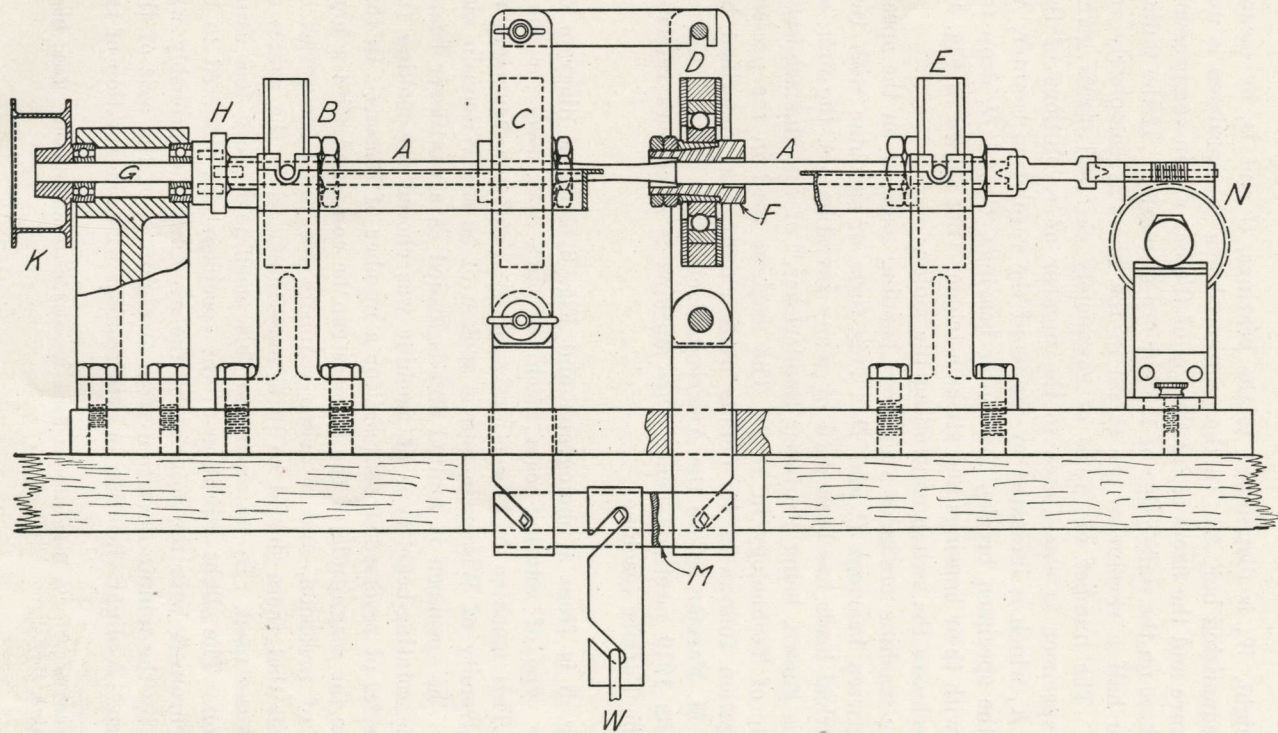

FIG. 4. DIAGRAM OF ROTATING-BEAM TESTING MACHINE (FARMER)

The weight, W , is distributed to the bearings, C and D , by means of the equalizing bar, M . In the position shown the specimen is under flexure and the fibers along the top of the bar are in compression while those on the under side of the bar are in tension. If the pulley is given half a revolution the stress in the fibers is completely reversed. The number of cycles of completely reversed stress given to the specimen is equal then to the number of revolutions of the pulley, K , which is indicated by means of the revolution counter, N . When the specimen breaks, the center bearings, C and D , drop together with their housings and strike a trigger (not shown in Fig. 4) which releases the switch controlling the motor.

The machine produces a uniform bending moment on the specimen between bearings C and D . This form of machine with two symmetrical loads has been used by many investigators, the first, so far as is known, being Professor Sondericker,* of the Massachusetts Institute of Technology in 1892. The machine used in the present investigation follows in its details quite closely that described by Mr. F. M. Farmer before the American Society for Testing Materials at its 1919 meeting; hence, this machine is sometimes referred to as the Farmer machine.

Fig. 5 is from a photograph and Fig. 6 shows a diagram of another type of rotating-beam machine which was used for some tests. This machine had been designed by Professor Kommers at the University of Wisconsin and is spoken of as the Wisconsin machine. The specimen is rotated and is loaded as a cantilever beam.

The rotating-beam type of machine was chosen for making the basic series of reversed-stress tests for a number of reasons. In this machine the magnitude of the stresses can be computed with a high degree of precision, and a prime requisite for the basic series of tests was that there should be little uncertainty as to the values of the stresses used. In its operation this machine is very free from vibration. The slight vibration of the specimen was observed to be in synchronism with the rotation of the machine, and probably was caused by the minute deviation from straightness of the axis of the specimen. A slight vibration in synchronism with the rotation of the

* Sondericker, J. "A Description of Some Repeated-Stress Experiments," Tech. Quar. Boston, April, 1892.

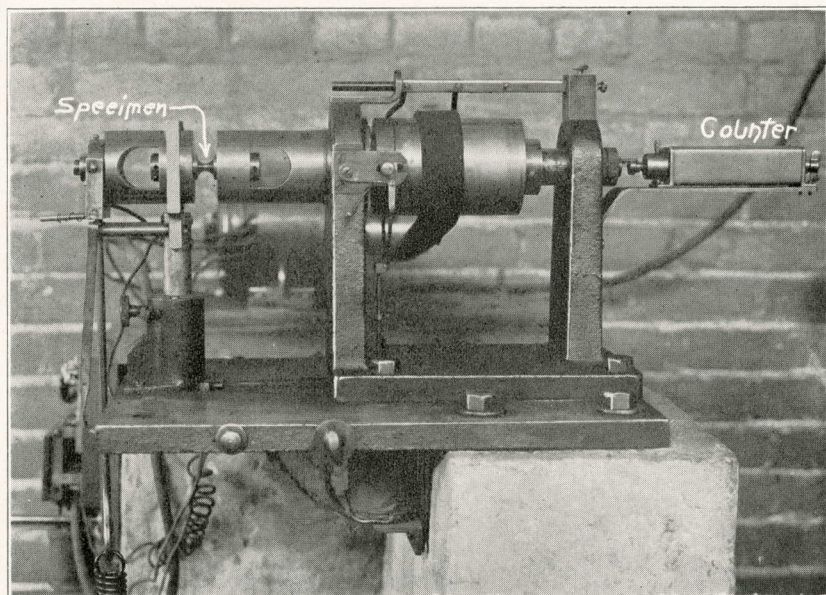

FIG. 5. ROTATING-BEAM TESTING MACHINE (WISCONSIN)

specimen does not alter the range of stress to which the specimen is subjected. The results obtained by this type of machine are not seriously affected by slight changes in speed. The writers made a

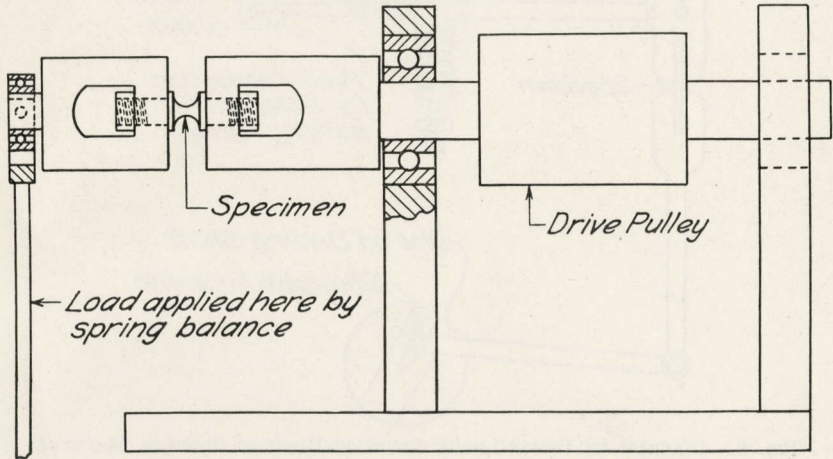

FIG. 6. DIAGRAM OF ROTATING-BEAM TESTING MACHINE (WISCONSIN)

somewhat careful search for test results at various speeds and found considerable evidence* that speeds below 2000 revolutions per minute have very little effect on the result of repeated-stress tests.

In another type of repeated-stress testing machine calibrated springs are used to resist and to measure the bending moment or the twisting moment applied to the specimen. Two machines of this type were used for a secondary series of reversed-stress tests. Fig. 7 is from a photograph of the Upton-Lewis machine used for flexural reversed-stress tests. Fig. 8 shows the scheme of the machine diagrammatically. In this machine the specimen is bent back and forth in one plane. The amount of deflection of the springs, and hence the magnitude of the bending moment applied to the specimen, is given by the width of the diagram drawn by the pencil point. The number of cycles of bending stress is shown by the counter. Fig. 9

* Stanton and Pannell, *Inst. Civ. Engrs. (British)*, CLXXXVIII, p. 814, 1911.

Hopkinson, B. *Proc. Royal Soc., A* 86, January 31, 1912; *Sci. Abs.*, 1912, No. 628.

Roos, J. O. *Int. Assn. for Test. Materials*, 1912, Art. V2B.

Kommers, J. B. *Int. Assn. for Test. Materials*, 1912, Art. V4B.

Stanton and Bairstow, *Inst. Civ. Engrs. (British)*, CLXVI, p. 78, 1905-6.

Upton and Lewis, *American Machinist*, October 17, 1912, p. 633.

Eden, Rose, and Cunningham, *Inst. Mech. Engrs. (British)*, 1911, Part 3-4, p. 839.

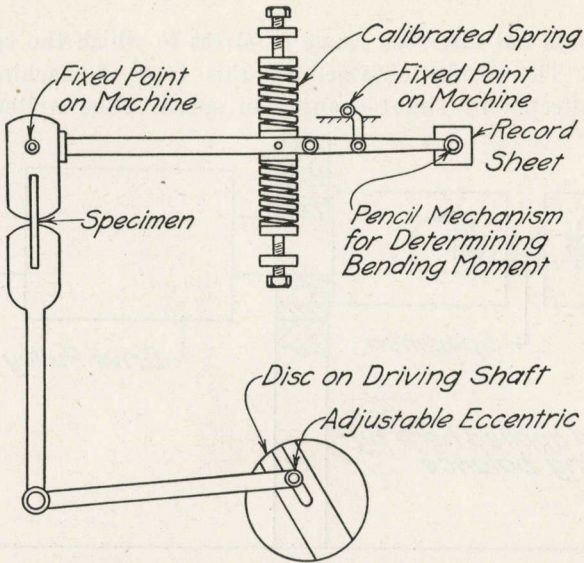

FIG. 8. DIAGRAM OF UPTON-LEWIS REVERSED-BENDING TESTING MACHINE

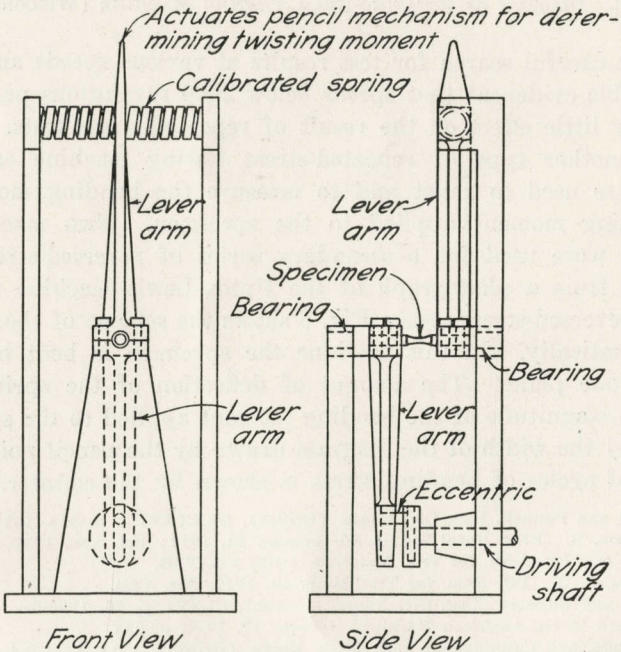

FIG. 10. DIAGRAM OF OLSEN-FOSTER REVERSED-TORSION TESTING MACHINE

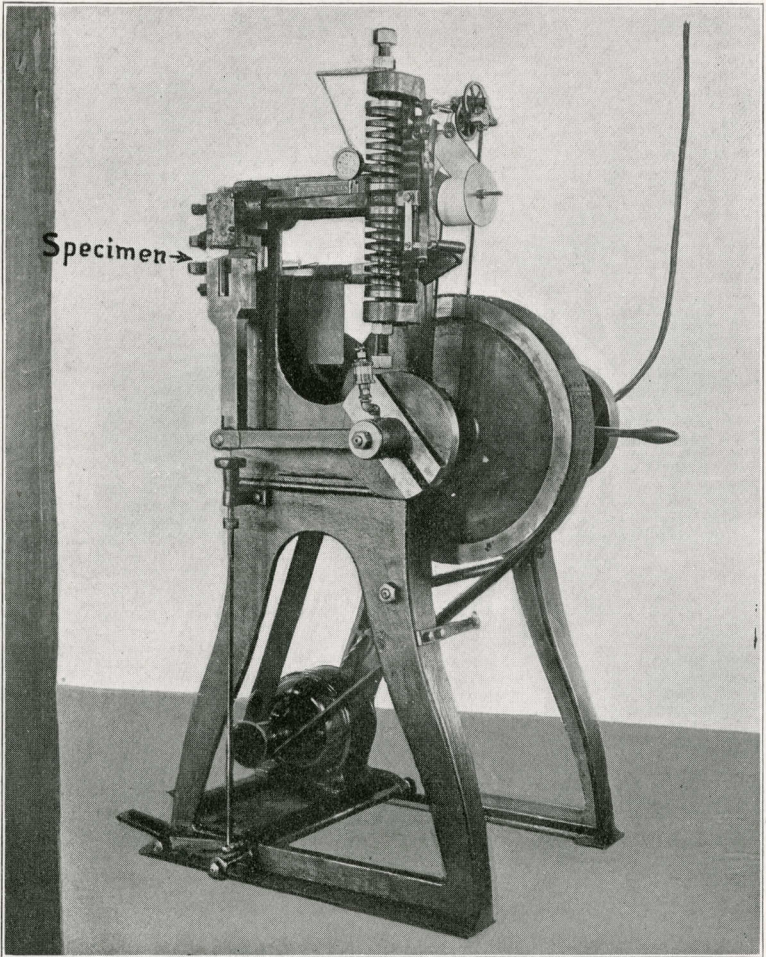

FIG. 7. UPTON-LEWIS REVERSED-BENDING TESTING MACHINE

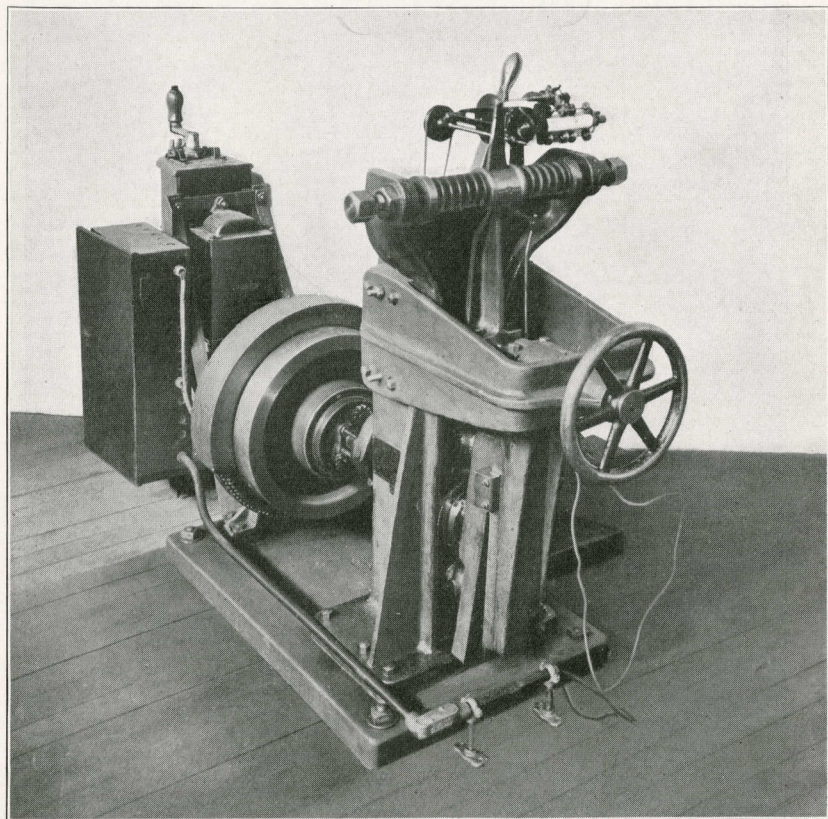

FIG. 9. OLSEN-FOSTER REVERSED-TORSION TESTING MACHINE

is from a photograph of the reversed-torsion machine, the Olsen-Foster, while Fig. 10 gives a diagram of the same machine. The specimen is subjected to an amount of twist in one direction from the neutral position, and then to the same amount of twist in the opposite direction. The scheme for measuring twisting moment and number of cycles of twisting stress is similar to that used in the Upton-Lewis machine.

These spring machines are, however, very much more expensive than the rotating-beam machine, and, moreover, the error inherent in spring calibration and the stresses caused by the inertia of reciprocating parts introduce some uncertainty as to the magnitude of some of the stresses. A further objection to these machines is that they cannot be run satisfactorily at speeds as high as 1500 revolutions per minute.

All the fatigue machines were provided with automatic devices which stopped the machines when the specimen failed. These devices made continuous operation of the machines possible.

Repeated-stress testing machines, which depend upon the inertia of reciprocating or rotating parts for producing stress, have sometimes been used. Such machines are markedly affected by variations in the speed, since the inertia effect is proportional to the square of the speed. In tests which last for days at a time the power circuit ordinarily available cannot be relied upon to give constant speed at the motors, unless there is a very elaborate and expensive installation of speed-regulating devices. This consideration caused the rejection of the inertia type of repeated-stress testing machine for this investigation.

Testing machines employing alternating current magnets to produce repeated stress were considered. These machines would be very much more expensive than the rotating-beam type of machine, and, moreover, slight variations in the frequency of the alternating current (such variations as would inevitably occur in the current supplied to the laboratory) might produce quite serious variations in the force set up by the magnets.

There would seem to be some advantage in using machines which produce repetitions of direct tension or compression in a specimen. The only available machines producing such stress were of the alternating current magnet type or of the inertia type, and were so ex-

pensive that the funds of the investigation would not have permitted purchasing a sufficient number of machines.

To sum up, the rotating-beam machine was chosen for the basic series of tests primarily because it seemed to be a machine in which, within the yield point, definite stresses could be set up with a high degree of precision, because it seemed least affected by slight variations of frequency in the electric circuits supplying power, and because it was the least expensive machine to construct.

As noted above, a careful study of the records of other tests seems to indicate that speed of testing has little effect on the results up to a speed of about 2000 revolutions per minute. The speed chosen for the Farmer machine was well within this limit, namely, 1500 revolutions per minute. With the Upton-Lewis machine a speed of 300 revolutions per minute was used; with the Olsen-Foster machine, a speed of 350 revolutions per minute was used, except for the 0.93 carbon steel, troostitic, the 0.49 carbon steel, sorbitic, and the chrome-nickel steel, treatment A, for which a speed of 260 revolutions per minute was used; with the Wisconsin machine a speed of 1200 revolutions per minute was used.

For the static compression tests and tension tests a 100 000-pound Riehle machine and a 10 000-pound Olsen machine were used. For the static torsion tests a Riehle 10 000-inch-pound machine of the pendulum type was used. In the last-named machine the twisting moment exerted on the specimen is read from a micrometer dial gage which indicates a motion of 0.001 inch, and which is actuated by the movement of the pendulum from its neutral position.

Fig. 11 is from a photograph of the Charpy impact machine which was used to make the impact-bending and impact-tension tests. In the single-blow impact testing machine, of which the Charpy machine is one type, a heavy pendulum is raised to a given angle from its normal position and then is allowed to fall against a specimen. Rupturing the specimen (a short beam with a notch in it for the impact-flexure test), the pendulum passes the neutral position and rises to an angle indicated by a "maximum" finger. The difference between angle of fall and angle of rise is a measure of the energy absorbed in rupturing the specimen.* A centering device

* Dix, E. H., Jr. Proc. Am. Soc. for Test. Materials, Vol. XIX, Part II, p. 720, 1919. This is a detailed discussion of the single-blow impact testing machine.

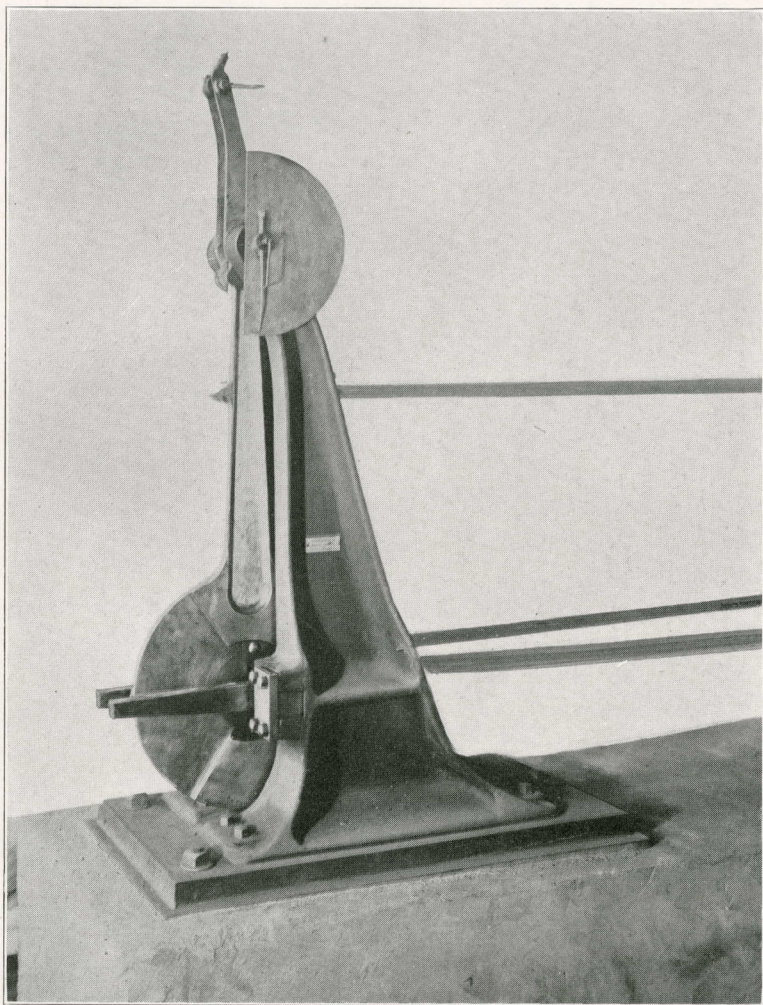

FIG. 11. CHARPY SINGLE-BLOW IMPACT TESTING MACHINE

was used for placing the impact-bending specimen in the machine, so that the pendulum would strike opposite the center of the notch.

Fig. 12 shows the apparatus which was designed for use with the Charpy machine in making the impact-tension test.* As is

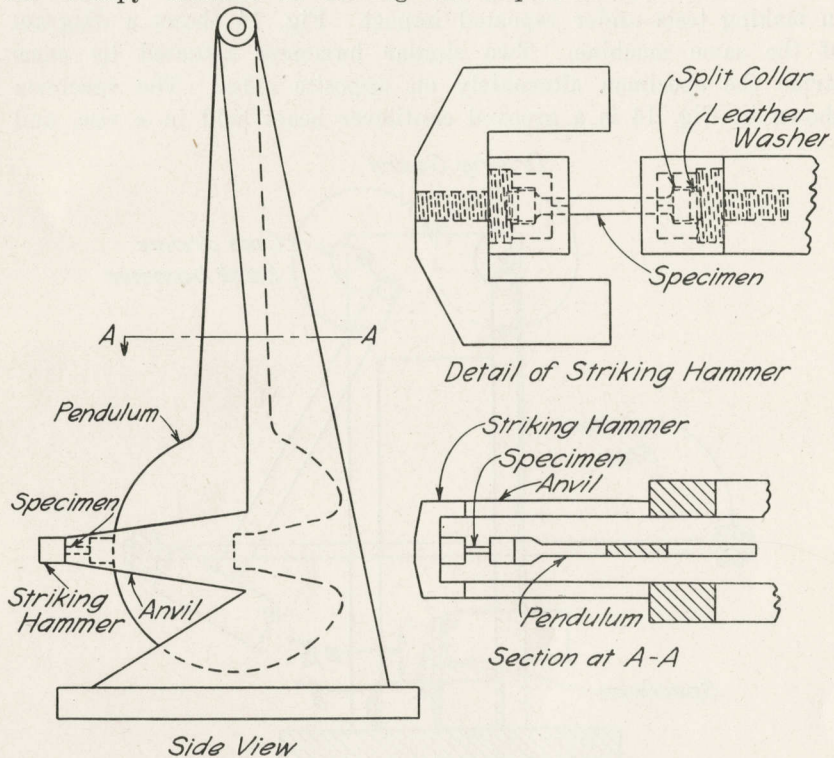

FIG. 12. TENSION TEST ATTACHMENT FOR CHARPY IMPACT TESTING MACHINE

*When making impact-tension tests there is one serious objection to the Charpy impact machine in its present form. The hammer strikes the anvil when the pendulum reaches its neutral position. The center of gravity would at that instant be moving in the horizontal direction. However, it will be seen that the point where the specimen is attached to the pendulum is still moving with a component in the downward direction. When a specimen is quite ductile so that its percentage of elongation is, say, 30 per cent, this allows the specimen to be bent downward while it is being stretched out. The result is that a certain amount of energy is absorbed by the specimen in this bending action, and this energy is credited to the steel as energy of rupture. With specimens that break without much elongation there is no appreciable error of this kind.

This error of the machine might be corrected in two ways. One would be to shorten the anvils or design the hammer in such a way that when the hammer strikes the anvil the specimen will be moving in a horizontal direction. This method would reduce the maximum capacity of the machine. A second method would be to design the anvil and hammer so that the striking surfaces would be at right angles to the direction in which the specimen is moving at the instant of striking.

shown in the sketch, the specimen is provided with spherical seats at the shoulders so that there may be slight adjustment of the specimen when the hammer strikes the anvil.

Fig. 13 is from a photograph of the double-blow machine used in making tests under repeated impact. Fig. 14 shows a diagram of the same machine. Two similar hammers actuated by cams strike the specimen alternately on opposite sides. The specimen shown in Fig. 14 is a grooved cantilever beam held in a vise, and

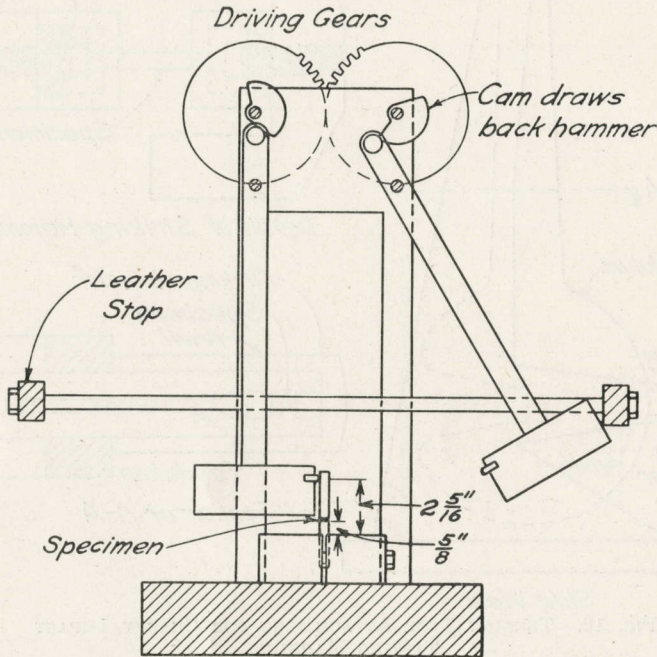

FIG. 14. DIAGRAM OF REPEATED-IMPACT TESTING MACHINE

is made from the ends of the broken Farmer rotating-beam specimens. The energy of each blow delivered is $1/3$ foot-pound, the velocity of the hammer as it strikes the specimen is 3.25 feet per second, and the machine delivers 65 double blows per minute. The number of blows withstood before failure is taken as the measure of the ability of the material to withstand this test. When a specimen breaks, the switch controlling the motor is automatically opened and the machine stopped.

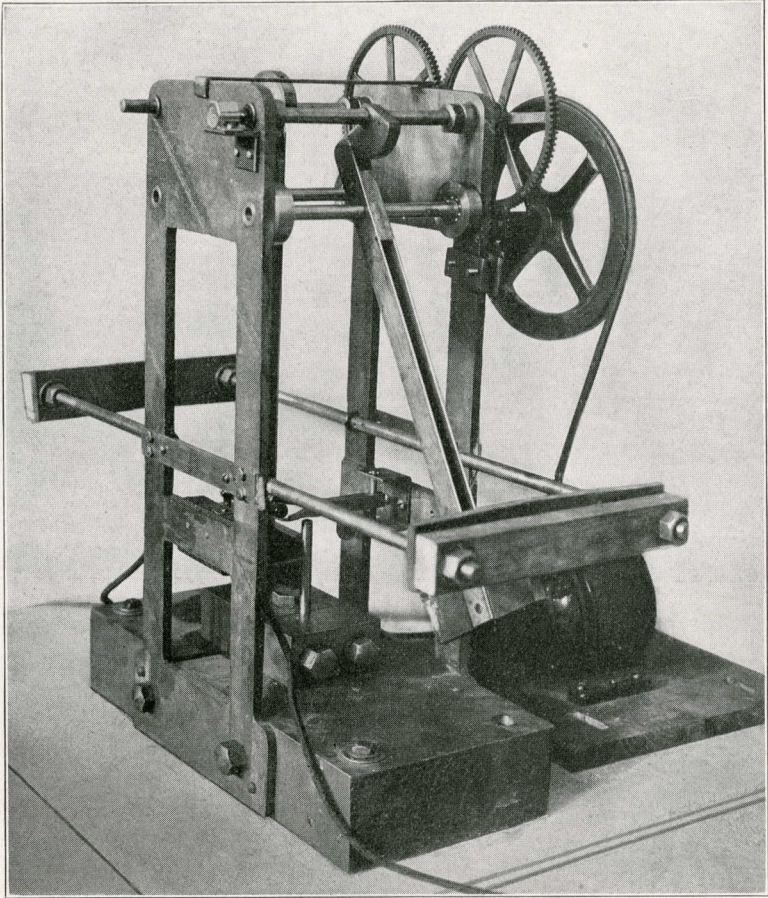

FIG. 13. REPEATED-IMPACT TESTING MACHINE

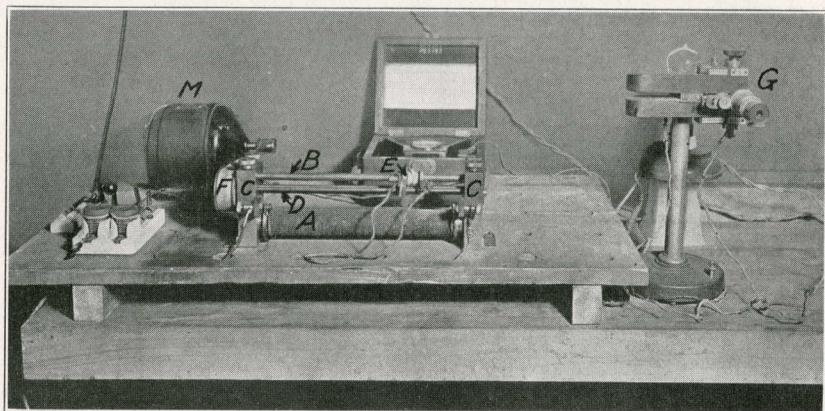

FIG. 15. APPARATUS FOR MAGNETIC TESTS

Fig. 15 shows a photograph of the magnetic testing machine which was used in making the test for homogeneity. This machine was constructed at the University of Illinois. It follows closely designs suggested by Dr. C. W. Burrows of New York, and by R. L. Sanford of the United States Bureau of Standards. The steel core at *A* was wound with wire which carried a current of 7.5 amperes. The magnetic circuit was completed through the specimen, *B*, and the uprights, *C*. At *D* is a screw threading through the small carriage at *E*. When the pulley, *F*, at the end of the screw is driven from the motor, *M*, the carriage, *E*, is moved over the specimen at a uniform speed. The carriage surrounds the specimen and upon the carriage are two coils, differentially wound, in which a small electromotive force is induced when the carriage moves through the magnetic lines of force. From the two coils terminals extend to a string galvanometer, *G*. If the specimen, *B*, is homogeneous in structure and free from both irregularities of form and internal stresses the electromotive force in one coil neutralizes that in the other and there is no deflection of the galvanometer. If there is a non-homogeneous section of the specimen, then, as each coil in turn passes over that section, the balance of the coils is disturbed and deflection of the galvanometer results.* Experiments showed that this device was particularly sensitive in pointing out places in the specimen which had been overstressed. The machine was used, therefore, to determine that the specimens to be tested were homogeneous. Readings were taken of the maximum variation of the galvanometer while the coils were moved across the middle four inches of the specimen. The uniformity of the readings was taken as a criterion of the uniformity of the various specimens.

Fig. 16 shows the detrusion indicator used in the torsion tests for determining the amount of twist in the specimen over a gage length of 2 inches. The arm is 10 inches long from the axis of the specimen to the point of contact of the Ames dial.

Hardness tests were made using both the Brinell machine and the scleroscope. The Brinell machine used was made by the Aktiebolaget Alpha of Stockholm, Sweden. The standard load used was

*For a more complete discussion of this type of apparatus see Scientific Papers of the U. S. Bureau of Standards, No. 343, and the 1917 Proc. of the Am. Soc. for Test. Materials, Part II, p. 87.

3000 kilograms (except for the 0.02 carbon steel, which was so soft that a load of 500 kilograms was used), and the standard diameter of ball was 10 millimeters. The machine indicates the standard load by "floating" a piston which works in its cylinder without packing, and which is loaded with standard weights. The diameter of the

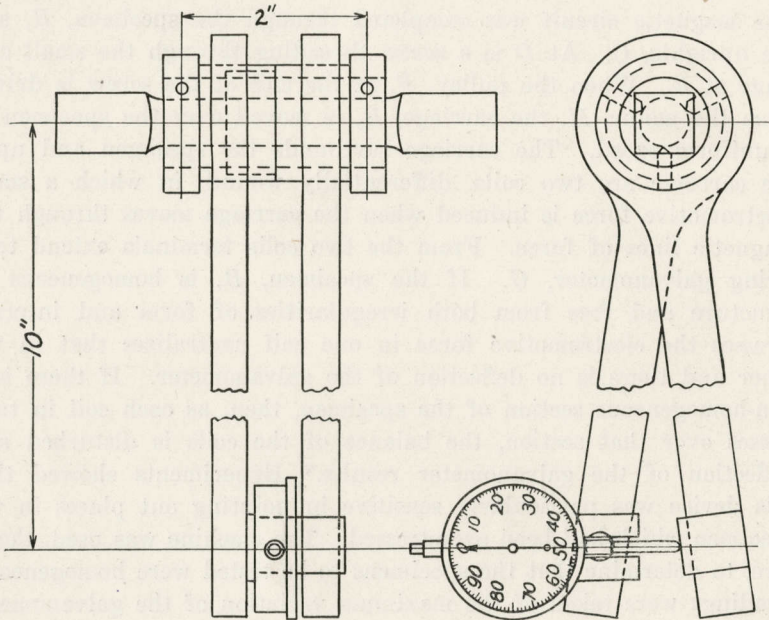

FIG. 16. DETRUSION INDICATOR FOR TORSION TESTS

ball used was measured by means of a micrometer, and found to vary less than 0.0025 millimeter from the standard diameter. The scleroscope used was a standard instrument manufactured by the Shore Instrument and Manufacturing Company of New York. The height of rebound of the hammer is read directly from a scale.

Fig. 17 is from a photograph of the heat-treating equipment used for heat treating most of the specimens. At A is shown a Hoskins electric furnace with inside dimensions 8 by 12 by 26 inches. This furnace was calibrated for uniformity of distribution of heat both empty and full, and it was found that, if specimens were kept in the rear half of the furnace, there was not more than

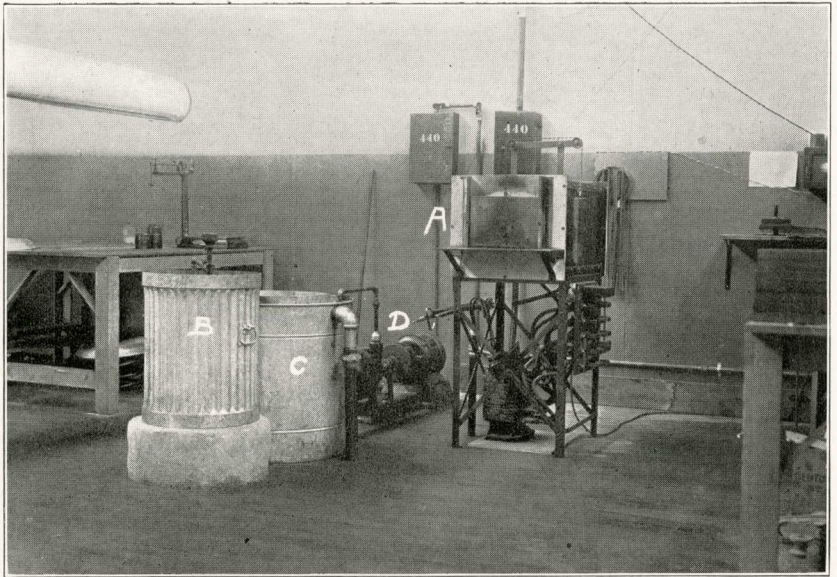

FIG. 17. HEAT TREATING EQUIPMENT

10 degrees centigrade variation of temperature for specimens in various locations in the furnace.

In measuring temperatures, two pyrometers were used, one of which had a platinum-rhodium thermocouple in the center of a dummy specimen, which was placed near the center of the pile of specimens in the furnace. This platinum-rhodium couple was connected to an Engelhard millivoltmeter. A constant-temperature cold junction was used with this pyrometer, and the cold junction was placed in a thermos bottle. The second pyrometer used a chromel-alumel couple connected to a Hoskins millivoltmeter. For this couple a correction was made for the variation of the cold-junction temperature, the cold junction being in the millivoltmeter case. Both pyrometers were calibrated at intervals by means of the freezing points of standard metals. In general, the chromel-alumel pyrometer was used merely as a check on the platinum-rhodium pyrometer.

At *B* is shown the water-quenching tank, which during the operation of quenching was supplied with running water. At *C* is shown the oil-quenching tank. Houghton's soluble quenching oil was used, and during the operation of oil-quenching the oil was circulated through pipes which were surrounded by running cold water. At *D* is shown the circulating pump. By this circulation the maximum variation in the temperature of the quenching oil was kept within 17 degrees centigrade.

9. *Test Specimens.*—Figs. 18 and 19 show the various forms of specimens which were used for determining the static and endurance properties of the steels.

The shape of the specimen used for the rotating-beam reversed-stress machine, shown in Fig. 18(a), was the result of considerable study. It was found in the first place that, if the specimen was not reduced in cross-section at the middle of its length, the localized stresses at the collets where the load was hung would usually cause the specimen to fail at the collets (*F* in Fig. 4). Various shapes were tried for the reduced part of the specimen. For one design a part of the specimen was reduced in diameter, and the change of section from the smaller to the larger was attempted with a taper. For another design a straight reduced section with fillets at the ends was used. It was found that specimens broke at the root of

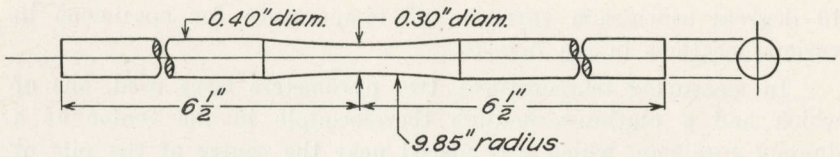

(a), Rotating Beam Specimen, Farmer Type

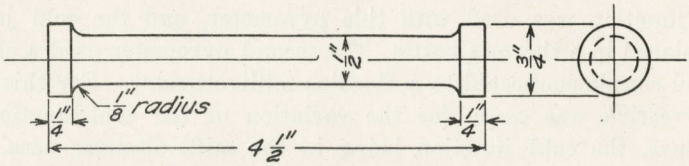

(b), Tension Specimen

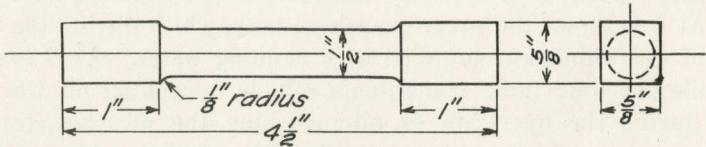

(c), Torsion Specimen

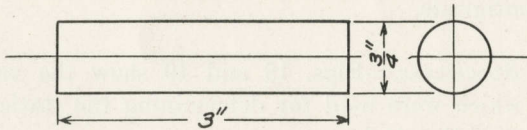

(d), Compression Specimen

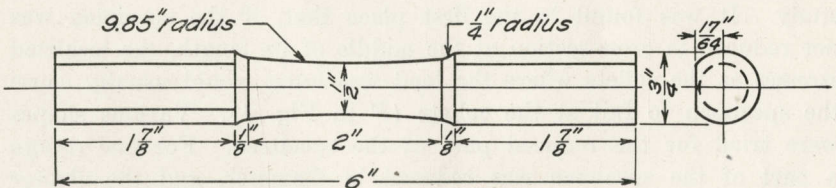

(e), Reversed Torsion Specimen, Olsen-Foster

FIG. 18. TEST SPECIMENS

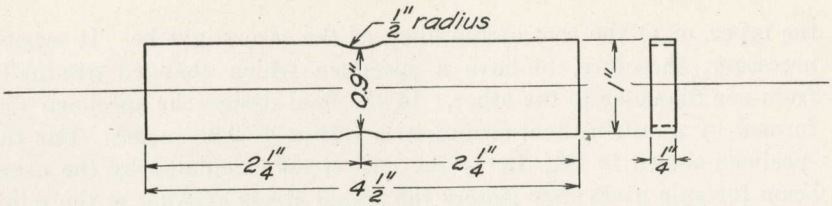

(a), Reversed Bending Specimen, Upton-Lewis

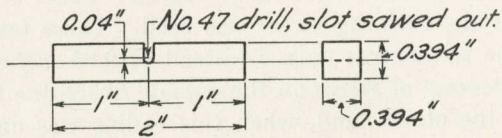

(b), Impact Bending Specimen, Charpy

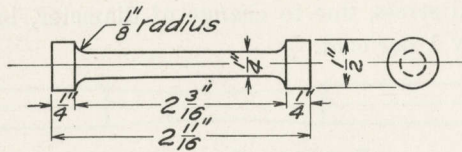

(c), Impact Tension Specimen, Charpy

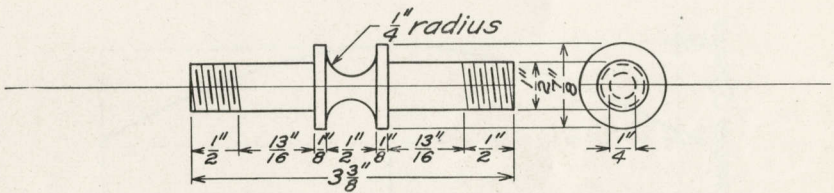

(d), Rotating-Beam Specimen, Wisconsin

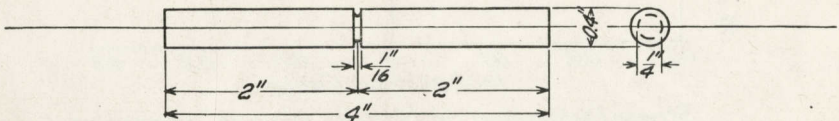

(e), Repeated Impact Specimen, Double-Hammer

FIG. 19. TEST SPECIMENS

the taper, or at the root of the fillet, as the case might be. It seemed necessary, therefore, to have a specimen which changed gradually from one diameter to the other. In the final design the specimen was formed by a cutting tool swung on a radius of 9.85 inches. For the specimen shown in Fig. 18(a) the unit stress calculated by the usual beam formula gives very closely the actual stress existing at the minimum section, as was proved by some tests on celluloid models made at the laboratories of the General Electric Company at Schenectady, New York, for this investigation. Professor Coker's polarized light apparatus for determining stress was used. These tests showed that even when the radius was only 5 instead of 9.85 inches there was no measurable increase of stress on the outside fibers due to curvature of section. On the other hand, when this radius was only 0.5 inch, it was found that the increase of stress on the outside fiber was considerable. With a radius of 9.85 inches there is practically uniform stress over about 0.20 inch near the middle of the span (Fig. 20), the variation in computed stress, due to change of diameter, in this range of length being only 1 per cent.

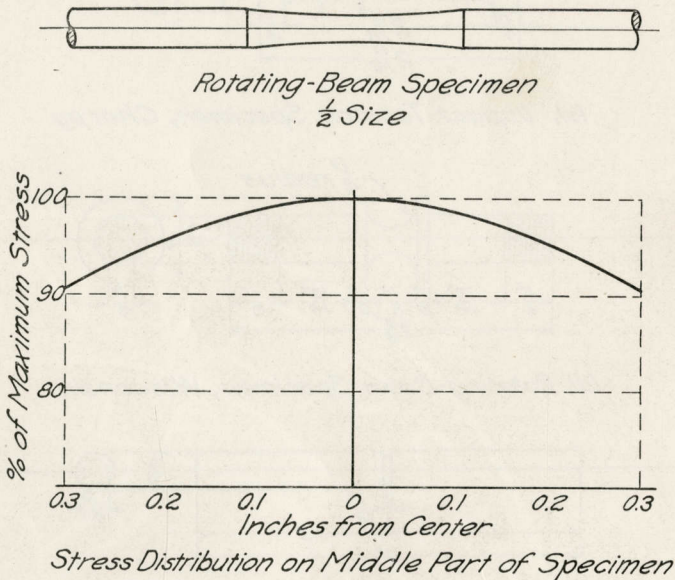

FIG. 20. VARIATION OF STRESS ALONG FARMER-TYPE TEST SPECIMEN

Usually the diameter at the reduced section was made 0.30 inch, but in the case of the stronger steels it was found that with this diameter they would still break at the collets. It was necessary in some cases, therefore, to reduce the diameter to 0.27 inch.

In the case of the reversed-torsion specimen, shown in Fig. 18(e), exactly the same phenomena were exhibited as described for the rotating-beam specimen. When the ends of the specimens were joined by a fillet to the smaller diameter at the middle, the specimens always failed at the root of the fillet. The specimens were therefore cut down at the middle with the same radius as was used in the case of the rotating-beam specimen.

A similar problem was encountered with the reversed-bending specimens used in the Upton-Lewis machine. In this machine the distance between the jaws holding the specimen is 0.50 inch. The specimen was first cut down with a radius of 0.75 inch, but it continued to break at the edges of the jaws because of the local stresses existing there. It was, therefore, necessary to weaken the specimen further and a radius of 0.5 inch was finally adopted. With this radius the specimens break at the minimum width instead of at the jaw edges. Fig. 19(a) shows the specimen used for the Upton-Lewis machine. Of course with this radius the change of section is rapid enough to produce some localized stress, and this is shown by the fact that the endurance limits (unit stress which the steel will withstand indefinitely) determined by the Upton-Lewis machine are uniformly lower than those obtained from the rotating-beam machine.

Fig. 18 shows the specimens used for the static tests. Fig. 18(b) shows the tension specimen, Fig. 18(c) the torsion specimen, and Fig. 18(d) the compression specimen. In the compression tests a spherical-seated bearing block was used, and the specimen was centered in the machine by means of a template. In the tension tests spherical bearings were also used, and the shoulders of the specimen rested in split sockets.

In some cases tension specimens were made from the ends of rotating-beam specimens. The shape was similar to that of Fig. 18(b) except that the diameter of the reduced part of the specimen was only 0.25 inch. This form of specimen was used for check tests and for material supplied in the form of rods less than 0.75 inch in

diameter. In all tension tests the elongation was measured on a gage length which was four times the diameter of the specimen,

Fig. 19(b) shows the specimen used for the Charpy impact-bending test, while Fig. 19(c) shows the one used for the Charpy impact-tension test. Fig. 19(e) shows the specimen used for the repeated-impact tests. This specimen was made from the uninjured ends of Farmer rotating-beam specimens. The repeated-impact specimen is a grooved cantilever beam.

Brinell tests and scleroscope tests for hardness were made on the ends of the torsion specimens shown in Fig. 18(c).

The magnetic tests were made on the rotating-beam specimens before they were reduced at the center.

10. *Finish of Specimens.*—From previous investigations it was known that surface finish exerted a marked effect on the endurance of a specimen under repeated stress. It was planned, therefore, to use a standard finish which could be duplicated on successive specimens and which would at the same time be of sufficient fineness so that the endurance of the specimen would practically not be reduced because of the finish. The procedure on the rotating-beam specimen for the Farmer machine was as follows: first, to turn the reduced portion at the center with an ordinary lathe tool; next, to file the specimen to remove the deepest tool marks; and finally to polish first with No. 0 and then No. 00 emery cloth.

That this finish was satisfactory is indicated by the uniformity of results, and it is shown in the section on "Effect of Surface Finish" that the polish was sufficiently good to attain uniform and satisfactory results.

The fatigue specimens for the machines other than the Farmer type were finished in a similar manner.

11. *Numbering of Specimens.*—The system adopted for numbering the specimens was designed to make it possible to identify each specimen tested. The original billets or bars, as the case might be, were nearly all cut into 13-inch lengths, because the longest specimen, the rotating-beam fatigue specimen, was 13 inches long. The marking system used may be illustrated by an example. In the mark 5A39C, the numeral 5 showed that this specimen was made

of steel number 5 or chrome-nickel steel; the letter *A*, that the specimen was from bar or billet *A*; the numeral 39, that it was located 39 inches from the end of the bar; and the letter *C*, that the specimen occupied the position *C* in the cross-section of bar *A*, according to the diagram for cutting up the bars which had been adopted for steel number 5.

Fig. 2 shows the plan which was used in cutting up the various steels. Taking Steel No. 4, 0.37 carbon sorbitic, as an illustration, the numbers directly above the diagram show that one set of specimens was cut up from 0 to 13, or 13 inches long; that another set was cut up from 13 to 16, or 3 inches long; another from 16 to 21, or 5 inches long, etc. This was the first steel cut up; all succeeding steels were cut up into 13-inch lengths.

12. *Procedure in Tests—Accuracy and Sensitiveness.*—The regular static tension and compression tests were carried out on a 100 000-pound Riehle machine. This machine was calibrated by means of calibrating levers and dead loads before it was used for testing purposes. It was found that the machine was sensitive to 10 pounds up to 23 000, beyond which it was not tested. The machine was accurate to about 0.6 per cent at 5000 pounds and to 0.4 per cent at 20 000 pounds.

For the static tension and compression tests a Ewing extensometer was used to measure deformation over a gage length of 1.25 inches. This extensometer was calibrated with a Brown and Sharpe micrometer screw, and it was found that one division on the extensometer scale represented a unit deformation of 0.00006925 inch per inch of gage length, or the sensitiveness was 0.00006925 inch per inch by estimation.

The aim in the static tests being to get at least ten increments of strain (as shown by extensometer readings) up to the yield point of the material, the following procedure was adopted. An initial load, which in the tension test was 400 pounds, was put on the specimen and a reading taken on the extensometer. Load was then applied until the extensometer showed the desired increment of deformation, and load and extensometer readings were recorded. The load was then reduced to the initial reading of 400 pounds and the extensometer reading was again recorded. The load was then in-

creased until the extensometer showed the standard increment above the previous reading, and, after reading load and extensometer, the load was again reduced to 400 pounds. This procedure was continued up to the vicinity of the elastic limit, when smaller increments of extension were used—usually about half the initial values—in order to determine the form of the curve more exactly.

The purpose of this procedure was to make a determination of the elastic limit as based on permanent set, as well as the more commonly used limit based upon proportionality of unit stress and unit deformation.

Fig. 21(a) is a sample tension stress-deformation curve which will make clear the manner in which the two elastic limits were determined. Curve *A* is the usual curve showing unit stress as ordinate and unit deformation as abscissa. In determining the proportional elastic limit, an inclined line, *OB*, was drawn corresponding to a rate of deformation 25 per cent greater than that represented by the original curve. This is done by taking any point below the elastic limit and making the offset, *DE*, 25 per cent of the distance *CD*. The inclined line *OB* is then drawn through the point *E*. Next a line parallel to *OB* is drawn tangent to the curve. The unit stress at the point of tangency is taken as the proportional elastic limit.

The attempt is often made to determine the proportional elastic limit by determining the unit stress at which the stress-deformation curve first deviates from a straight line. It is difficult to determine this point accurately, and it seemed desirable to use some such method as was adopted in order to have a tangent line whose deviation from the curve could be detected at two different points. It is then quite easy to determine the unit stress half way between these two deviation points. The rate of deformation 25 per cent greater than the original curve was chosen because it gave a line only slightly less steep than the original curve. It is believed that this method of determining the proportional elastic limit is satisfactory, considering the use which is to be made of this property of the material. This is a slight modification of the method proposed by J. B. Johnson.*

Another consideration in favor of the method is the fact that it is independent of the scale to which a stress-deformation curve is

* Withey and Aston, "Johnson's Materials of Construction," Fifth Edition, p. 10.

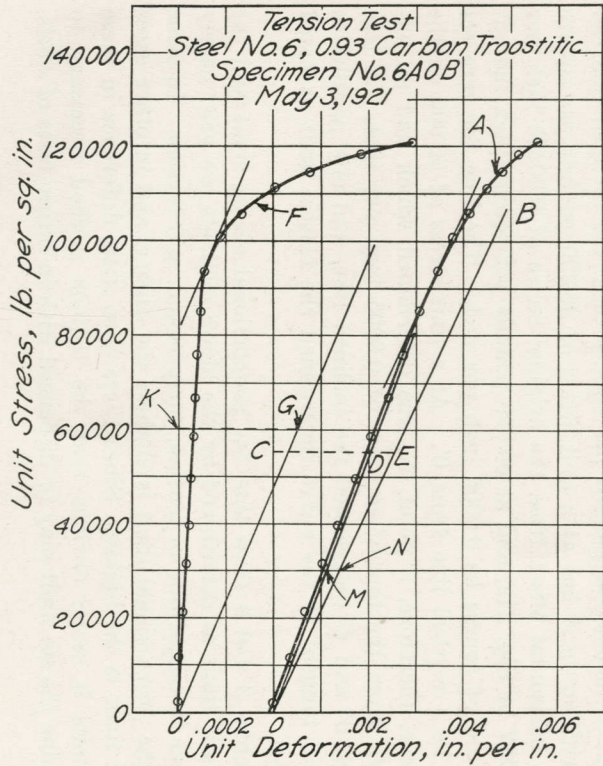

(a)

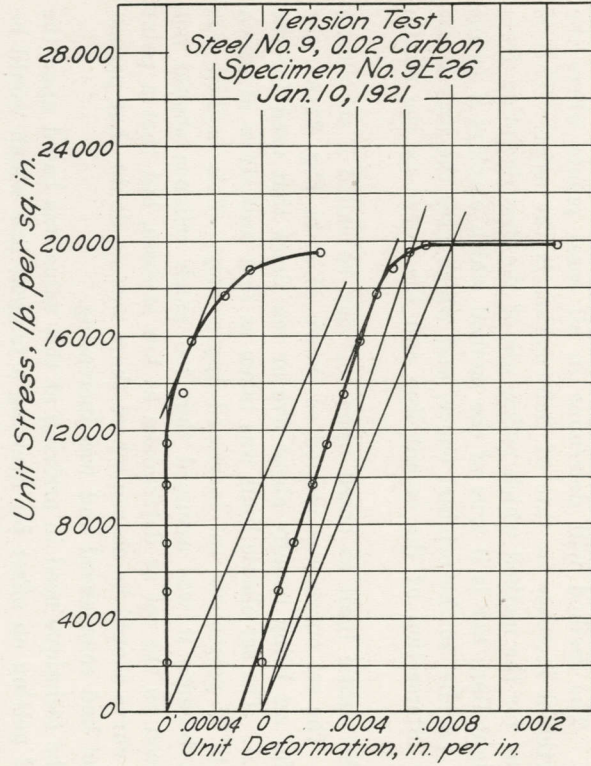

(b)

FIG. 21. REPRESENTATIVE STRESS-STRAIN DIAGRAMS FOR TENSION TESTS

drawn. The method will determine in all cases points where the proportional increase in rate of deformation is the same. This is not true for the method which makes use of the first deviation from a straight line; nor is it true of the method which employs a secant drawn parallel to the original curve, and which uses the unit stress at the intersection of the secant line and the curve as the elastic limit.

The elastic limit as based upon set may be called a set elastic limit. The set curve was plotted as shown at F in Fig. 21(a), the scale for set being usually about five or ten times that used for the curve A . The set elastic limit was taken as that unit stress at which the rate of permanent set increased appreciably. This method was chosen because it was assumed that too much reliance should not be placed on the set as determined at low stresses, but that a point in the curve should be chosen where there was no doubt that permanent set had commenced and was increasing.

The technique used in arriving at this value was based upon the idea of getting an offset for drawing a tangent line which would be about the same as the offset used in getting the inclined line OB , Fig. 21(a). Since the modulus of elasticity for steels is practically constant at 30 000 000 pounds per square inch, the inclined line OB used with curve A has at a unit stress of 30 000 pounds per square inch a horizontal offset from the original curve of 0.00025 inch per inch, MN in Fig. 21a, and at 60 000 pounds per square inch the offset would of course be 0.0005 inch per inch. The line for zero set would be a vertical line from O' . At a unit stress of 60 000 on the set curve, therefore, a point, G , was determined which had an offset, KG , from the line of zero set of 0.0005 inch per inch. A line through O' and G determined the inclined line, and one parallel to this and tangent to the curve determined the elastic limit as based upon set.

Tables 3 and 4 show that the proportional elastic limit and the set elastic limit as determined by the above methods are very nearly the same in magnitude in tension, compression, and torsion. In some cases the proportional limit is slightly the higher, and in other cases the set limit is the higher. Since there is so little difference in these two limits it seems obvious that the tedious method necessary to determine the set limit may be dispensed with in future tests of steels.

In the torsion tests readings of twisting moment and twist were taken in a manner similar to that already described for the tension and compression tests. The proportional elastic limits and the set elastic limits were also determined in a manner similar to that previously described. The micrometer dial of the detrusion indicator shown in Fig. 16 reads directly to 0.001 inch, and the reading can be estimated to 0.0001 inch. With this indicator, therefore, the twist of the specimen over two inches gage length can be read to 0.0001 radian directly, and to 0.00001 radian by estimation.

From the fatigue tests the fundamental information desired was the relation between the unit stress applied to the specimen and the number of cycles of stress necessary to cause rupture. The general practice with the Farmer machines was to stress the first specimen high enough so that it would break in a comparatively short time; then reduce the stress in the succeeding specimens, until finally a unit stress was arrived at which the steel could withstand for 100 000 000 cycles without failure. Wherever possible these long-time tests without failure were run on from three to five specimens for each of the steels investigated.

All values of stress calculated for the Farmer specimens are based upon the external load applied to the specimen, the weight of the specimen itself being neglected.

Only one Upton-Lewis and one Olsen-Foster machine were available. Consequently it was not practicable to make runs up to 100 000 000 cycles. In these machines, therefore, the stress was determined at which the specimen could withstand 2 000 000 cycles without failure. It will be found by consulting the curves which will be shown later that this determines the endurance limit fairly closely.

The Brinell and the scleroscope hardness tests were made on the rectangular surfaces of the uninjured ends of the static torsion specimens, the impressions being at right angles to the axis of the specimen. In each case impressions were taken on two adjacent sides, and in getting the diameter of the Brinell impression a microscope was used with a micrometer eyepiece which read to 0.1 millimeter directly, and to 0.01 millimeter by estimation.

It is not thought necessary to describe in detail the technique of impact tests or of magnetic tests.

III. TEST DATA AND RESULTS

13. *Summary of Test Data and Results.*—Tables 3, 4, and 5 give summaries of test results. Table 3 gives the results of the tension tests, and also the endurance limits as determined from the rotating-beam tests, so that comparisons may be conveniently made. Table 4 gives the results of the compression and the torsion tests. Table 5 gives the results of the hardness and the impact tests and also the endurance limits as determined by the rotating-beam, by the Upton-Lewis reversed-bending, and by the Olsen-Foster reversed-torsion machines. The last column in the table gives the "FR" point as determined by the Francke* test.

Table 6 shows a sample summary sheet, in this case for treatment A of the chrome-nickel steel. This table shows the number of results which were averaged in obtaining the results given in Tables 3, 4, and 5. Each Brinell and scleroscope result given in Table 6 is the average of several readings. Figs. 21-23 inclusive show representative stress-strain diagrams for tension, compression, and torsion tests.

Figs. 24-31 inclusive show the test results obtained on the Farmer machines for reversed-stress tests of the various steels. The method used in plotting these diagrams is discussed on page 90. Figs. 32 and 33 show similar diagrams obtained from the tests on the Upton-Lewis reversed-bending machine; while Figs. 34 and 35 show the diagrams for the Olsen-Foster reversed-torsion machine.

Fig. 28 shows *S-N* curves obtained in making a study of the effect of changes of shape on the endurance strength of steel. Fig. 29 shows similar curves obtained in making a study of the effect of surface finish on the endurance strength; while Figs. 30 and 31 show the *S-N* curves obtained in making a study of the effect of previous over-stressing on endurance strength.

Table 7 gives the results for all fatigue tests so far made in the course of the investigation.

The "rise of temperature" tests for endurance limit under reversed stress are treated in a special chapter, and the data for those tests are given in that chapter.

*Proc. Am. Soc. for Test. Materials, Vol. XX, Part II, p. 372, 1920.

TABLE 3
RESULTS OF TENSION TESTS

No.	STEEL	TENSION						Endurance Limit
		Set Elastic Limit	Proportional Elastic Limit	Yield Point	Ultimate	% of Elongation	% of Reduction of Area	Rotating Beam Machine
9	0.02 carbon, as received.....	14 400	16 100	19 000	42 400	48.3	76.2	26 000
51	Hot-rolled, as received.....	39 600	38 200	40 300	61 500	41.0	66.7	28 000
51	Hot-rolled, reduced to 0.48 in.....	60 100	60 000	63 300	67 600	22.3	63.3	35 000
51	Hot-rolled, reduced to 0.44 in.....	70 500	69 600	None	73 400	14.2	59.5	41 000
51	Hot-rolled, bent cold and straightened.....							30 000
50	Cold-drawn, as received.....	52 200	55 200	None	86 800	13.8	49.3	41 000
50	Cold-drawn, annealed at 1300° F.....	25 900	26 700	29 500	56 600	41.3	65.5	29 000
50	Cold-drawn, annealed at 1550° F.....	25 600	28 000	30 000	57 700	40.8	63.2	25 000
4	0.37 carbon, normalized.....	33 500	34 500	34 900	71 900	29.4	53.5	33 000
4	0.37 carbon, sorbitic, treatment A.....	82 000	80 600	87 300	102 600	23.3	65.1	57 000
4	0.37 carbon, sorbitic, treatment B.....	60 300	61 500	63 100	94 200	25.0	63.0	45 000
10	0.49 carbon, sorbitic.....	67 300	67 700	69 700	96 900	23.5	57.8	48 000

TABLE 3 (Continued)
RESULTS OF TENSION TESTS

No.	STEEL	TENSION						Endurance limit
		Set Elastic Limit	Proportional Elastic Limit	Yield Point	Ultimate	% of Elongation	% of Reduction of Area	Rotating Beam Machine
3	0.52 carbon, normalized	47 200	45 400	47 600	98 000	24.4	41.7	42 000
3	0.52 carbon, sorbitic	79 400	80 300	84 300	111 400	21.9	56.6	55 000
6	0.93 carbon, pearlitic	25 500	28 000	33 400	84 100	24.8	37.2	30 500
6	0.93 carbon, sorbitic	60 700	60 300	67 600	115 000	23.0	39.6	56 000
6	0.93 carbon, troostitic	102 200	97 200	None	188 300	9.9	29.3	98 000
1	1.20 carbon, normalized	59 100	58 600	60 700	116 900	7.9	11.6	50 000
1	1.20 carbon, sorbitic	119 600	120 400	130 100	179 900	9.0	15.2	92 000
7	3.5 nickel, treatment B	85 500	82 400	91 100	111 800	23.6	60.2	63 000
5	Chrome-nickel, treatment A	117 200	115 500	128 100	138 700	18.2	61.8	68 000
5	Chrome-nickel, treatment B	99 700	101 700	103 700	113 300	24.2	68.7	65 000
5	Chrome-nickel, treatment C	86 300	86 200	100 500	114 200	23.2	69.3	67 000

TABLE 4
RESULTS OF COMPRESSION TESTS AND TORSION TESTS

No.	STEEL	COMPRESSION				TORSION			
		Set Elastic Limit	Proportional Elastic Limit	Yield Point	Ultimate	Set Elastic Limit	Proportional Elastic Limit	Yield Point	Modulus of Elasticity
9	0.02 carbon, as received	19 400	19 200	20 600	31 200	12 400	12 500	13 600	11 770 000
4	0.37 carbon, normalized	36 800	36 300	38 100	59 200	19 800	20 300	22 500	11 790 000
4	0.37 carbon, sorbitic, treatment A	77 100	75 800	84 500	102 800	50 900	51 600	60 200	11 960 000
10	0.49 carbon, sorbitic	57 500	55 900	60 100	76 500	37 200	36 800	None	12 150 000
3	0.52 carbon, normalized	48 700	47 800	51 000	78 700	30 000	30 000	34 600	11 720 000
3	0.52 carbon, sorbitic	85 600	84 400	87 400	97 800	53 100	52 200	None	12 110 000
6	0.93 carbon, pearlitic	22 800	23 500	29 700	69 200	16 600	15 600	22 500	11 880 000
6	0.93 carbon, sorbitic	66 700	64 800	72 700	97 100	42 300	42 000	None	12 130 000
6	0.93 carbon, troostitic	105 300	106 500	None	77 500	75 200	None	11 960 000
1	1.20 carbon, normalized	55 400	55 300	57 900	96 500	36 400	36 500	39 700	11 700 000
1	1.20 carbon, sorbitic	104 400	102 700	111 500	149 200	82 700	80 600	None	11 940 000
7	3.5 nickel, treatment B	85 600	86 400	94 000	95 100	56 000	55 500	None	11 890 000
5	Chrome-nickel, treatment A	123 900	122 600	130 100	133 000	72 800	72 400	84 900	11 510 000
5	Chrome-nickel, treatment B	98 200	97 800	100 000	100 300	63 400	62 500	None	11 980 000
5	Chrome-nickel, treatment C	91 600	91 500	97 400	99 900	62 200	62 300	None	12 020 000

TABLE 5
RESULTS OF HARDNESS TESTS, IMPACT TESTS, FRANCKE TESTS, AND REVERSED-STRESS TESTS

No.	STEEL	Hardness		Impact Bending	Impact Tension			Endurance Limits			Francke Bending	Repeated Impact
		Brinell	Scleroscope	Energy of Rupture ft. lb.	Energy of Rupture ft. lb.	% of Elongation	% of Reduction of Area	Farmer Rotating Beam	Upton-Lewis Reversed Bending	Olsen-Foster Reversed Torsion	FR Point in Francke Test	Number of Double Blows
9	0.02 carbon, as received.....	69	18	19.3	84.9	27.0	72.7	26 000	23 000	12 500	260
51	Hot-rolled, as received.....	28 000	242
51	Hot-rolled, reduced to 0.48 in.....	35 000	280
51	Hot-rolled, reduced to 0.44 in.....	41 000	361
51	Hot-rolled, bent cold and straightened.....	30 000
50	Cold-drawn, as received.....	41 000	316
50	Cold-drawn, annealed at 1300° F.....	29 000	202
50	Cold-drawn, annealed at 1550° F.....	25 000	223
4	0.37 carbon, normalized.....	132	18	15.8	168.4	32.4	52.7	33 000	30 000	16 000	33 000	183
4	0.37 carbon, sorbitic, treatment A.....	209	26	53.2	163.2	24.0	62.8	57 000	32 500	550
4	0.37 carbon, sorbitic, treatment B.....	45 000	44 000	503
10	0.49 carbon, sorbitic.....	197	23	22.5	152.3	24.0	55.1	48 000	39 000	26 000	319

TABLE 5 (Continued)

RESULTS OF HARDNESS TESTS, IMPACT TESTS, FRANCKE TESTS, AND REVERSED-STRESS TESTS

No.	STEEL	Hardness		Impact Bend- ing	Impact Tension			Endurance Limits			Francke Bend- ing	Re- peated Impact
		Brinell	Sclero- scope	Energy of Rupture ft. lb.	Energy of Rupture ft. lb.	% of Elonga- tion	% of Reduc- tion of Area	Farmer Rotat- ing Beam	Upton- Lewis Rever- served Bend- ing	Olsen- Foster Rever- served Torsion	FR Point in Francke Test	Number of Double Blows
3	0.52 carbon, normalized	193	24	13.2	188.5	24.2	45.6	42 000	32 000	39 500	275
3	0.52 carbon, sorbitic	227	30	21.4	172.0	22.2	55.1	55 000	44 000	66 000	486
6	0.93 carbon, pearlitic	162	23	2.2	141.3	21.2	34.5	30 500	28 500	16 300	34 000	66
6	0.93 carbon, sorbitic	227	31	3.3	193.2	21.6	43.9	56 000	44 000	128
6	0.93 carbon, troostitic	380	51	4.4	186.8	15.0	41.3	98 000	52 000	227
1	1.20 carbon, normalized	224	31	1.9	88.8	8.8	14.6	50 000	45 000	39
1	1.20 carbon, sorbitic	369	45	2.0	109.1	6.3	11.0	92 000	172
7	3.5 nickel, treatment B	242	28	41.0	179.9	22.8	57.4	63 000	524
5	Chrome-nickel, treatment A	291	36	45.4	173.8	17.0	61.7	68 000	52 000	37 000	62 000	1073
5	Chrome-nickel, treatment B	247	28	53.8	175.3	22.2	63.2	65 000	31 500	714
5	Chrome-nickel, treatment C	246	29	56.0	187.6	23.4	67.0	67 000	722

TABLE 6
 REPRESENTATIVE SUMMARY SHEET
 Tests of Chrome-Nickel Steel, Treatment A

TENSION TESTS							COMPRESSION TESTS				
Specimen Number	Set Elastic Limit lb. per sq. in.	Proportional Elastic Limit lb. per sq. in.	Yield Point lb. per sq. in.	Ultimate lb. per sq. in.	Elongation per cent	Reduction of Area per cent	Specimen Number	Set Elastic Limit lb. per sq. in.	Proportional Elastic Limit lb. per sq. in.	Yield Point lb. per sq. in.	Ultimate lb. per sq. in.
5C26C	140 600	16.5	59.8	5C26C	126 500	125 000	132 700	136 700
5D13D	120 000	116 000	133 700	140 600	20.0	62.7	5D13D	128 000	126 500	138 000	140 000
5A91B	121 000	121 000	128 400	140 300	19.0	62.3	5A91B	127 000	124 000	130 300	133 900
5B65A	118 000	119 500	124 900	136 600	17.5	61.3	5B65A	121 000	120 000	127 200	131 100
5A39A	113 000	114 000	126 200	138 100	17.5	62.2	5A39A	122 500	120 000	126 700	131 000
5C78A	114 000	107 000	127 500	135 900	19.0	62.4	5C78A	118 300	120 000	125 700	125 700
Average	117 200	115 500	128 100	138 700	18.2	61.8	Average	123 900	122 600	130 100	133 000

TABLE 6 (Continued)
 REPRESENTATIVE SUMMARY SHEET
 Tests of Chrome-Nickel Steel, Treatment A

TORSION TESTS					HARDNESS	
Specimen Number	Set Elastic Limit lb. per sq. in.	Proportional Elastic Limit lb. per sq. in.	Yield Point lb. per sq. in.	Modulus of Elasticity lb. per sq. in.	Brinell	Scleroscope
5C26C	72 500	72 000	93 750	11 500 000	302	36
5D13D	77 500	78 000	86 100	11 380 000	302	36
5A91B	74 500	72 500	84 800	11 640 000	293	36
5B65A	72 500	70 500	83 200	11 630 000	289	36
5A39A	70 000	72 000	80 750	11 470 000	273	37
5C78A	69 500	69 500	80 500	11 420 000	286	35
Average	72 800	72 400	84 900	11 510 000	291	36

CHARPY IMPACT BENDING				CHARPY IMPACT TENSION				REPEATED IMPACT	
Specimen Number	Energy of Rupture ft. lb.	Specimen Number	Energy of Rupture ft. lb.	Specimen Number	Energy of Rupture ft. lb.	Elongation per cent	Reduction of Area per cent	Specimen Number	Number of Double Blows
5B78B	46.1	5B78B	47.8	5B78B	186.8	7.0	63.7	5D13A	1359
-5A104B	47.1	5A104B	45.4	5A104B	181.2	24.0	63.4	5A26A	1214
-5A26B	45.2	5A26B	46.9	5A26B	150.4	17.0	62.3	5B0B	1099
5C39C	44.9	5C39C	45.4	5C39C	180.4	22.0	61.7	5A117A	886
5C91C	41.8	5C91C	43.2	5C91C	170.3	15.0	57.2	5A130A	806
Average	45.4	173.8	17.0	61.7	1073

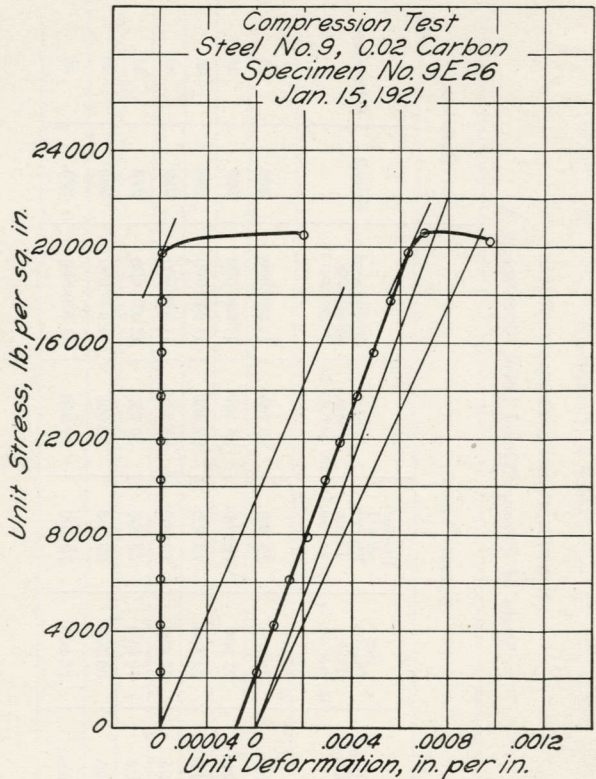
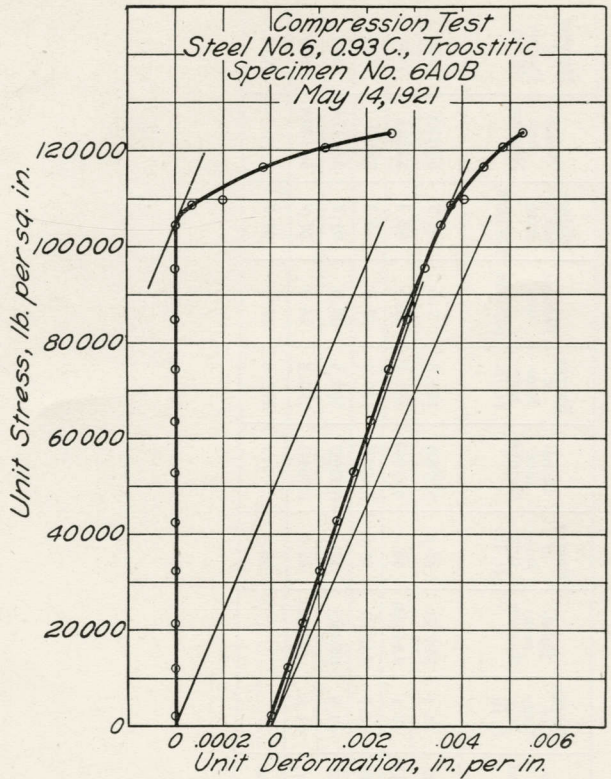

FIG. 22. REPRESENTATIVE STRESS-STRAIN DIAGRAMS FOR COMPRESSION TESTS

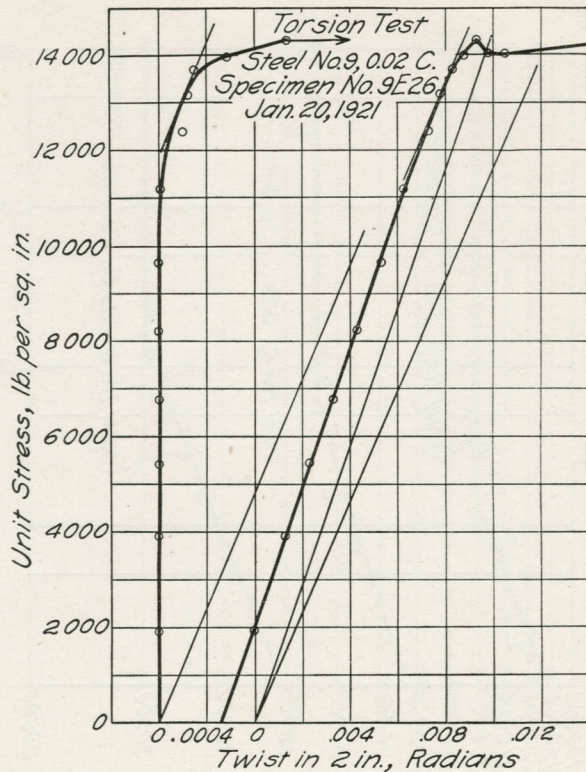
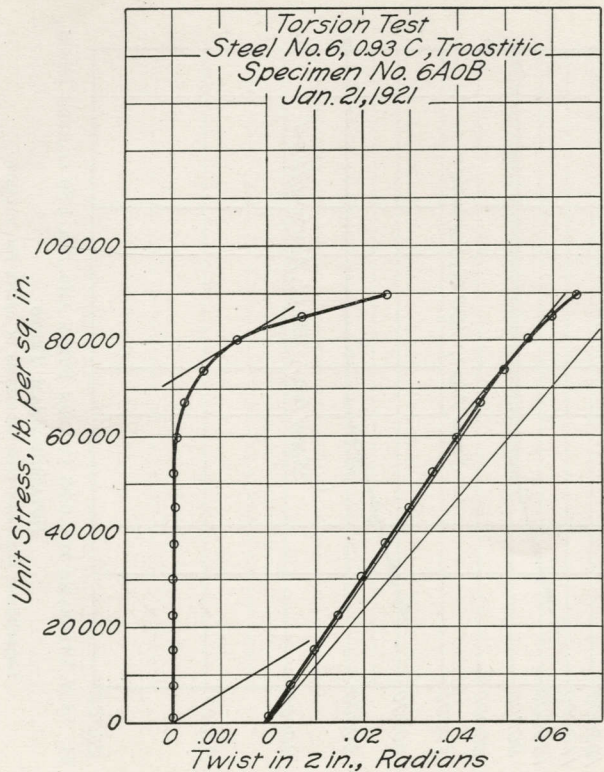

FIG. 23. REPRESENTATIVE STRESS-STRAIN DIAGRAMS FOR TORSION TESTS

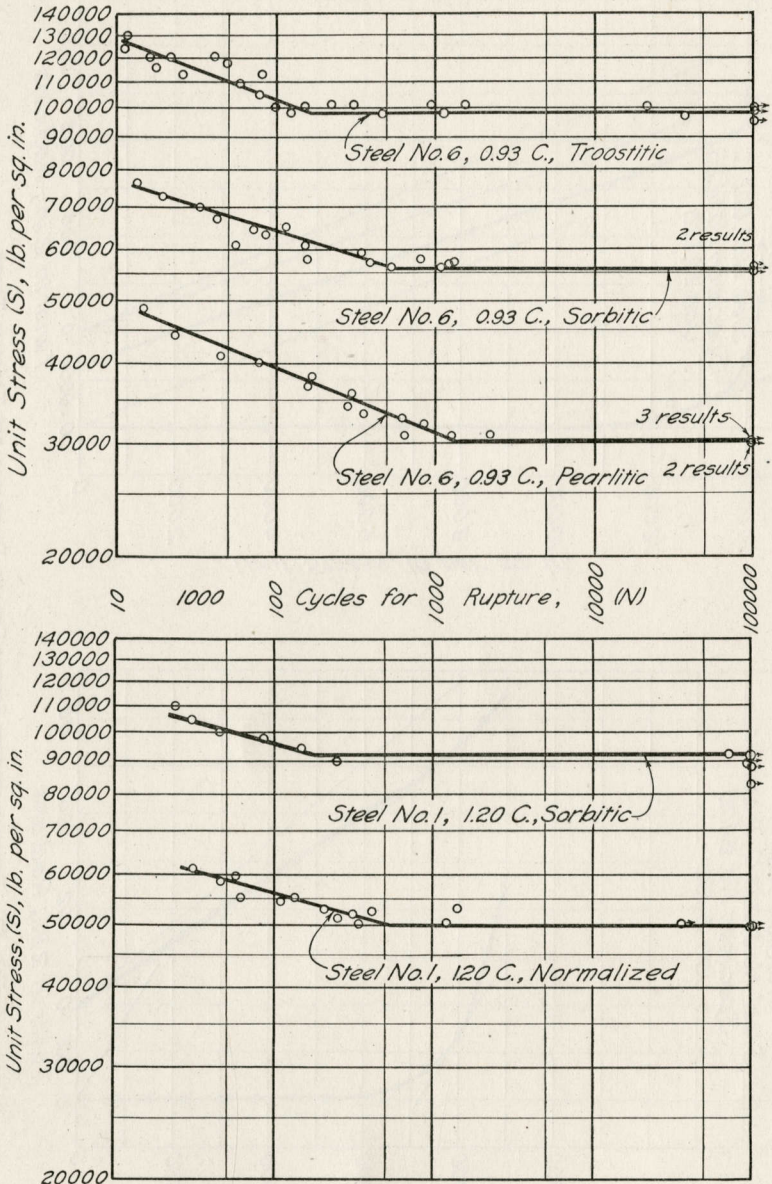

FIG. 24. S-N DIAGRAMS FOR 0.93 CARBON STEEL AND FOR 1.20 CARBON STEEL, ROTATING-BEAM TESTS

Logarithmic abscissas give thousands of cycles for rupture

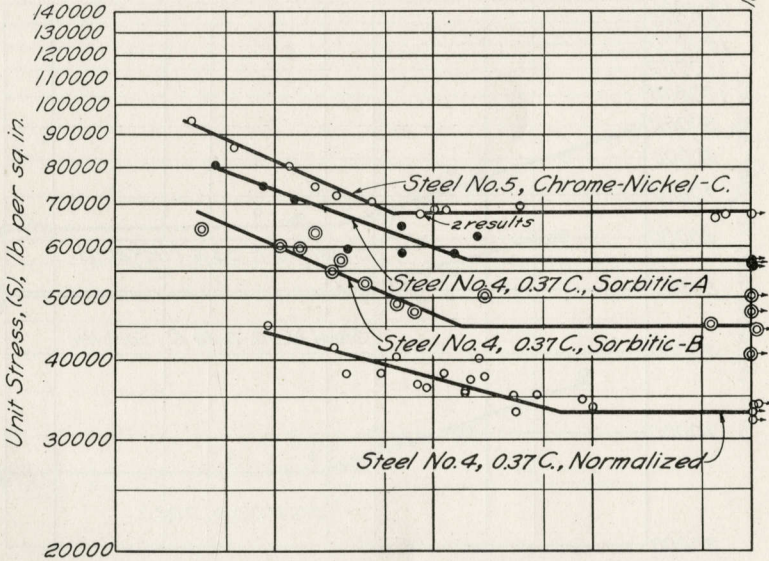
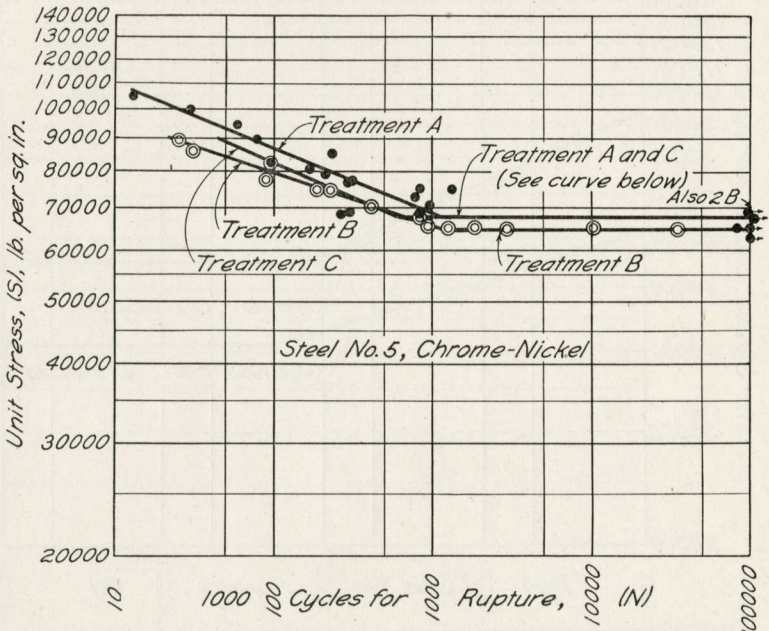

FIG. 25. S-N DIAGRAMS FOR CHROME-NICKEL STEEL AND FOR 0.37 CARBON STEEL, ROTATING-BEAM TESTS
Logarithmic abscissas give thousands of cycles for rupture

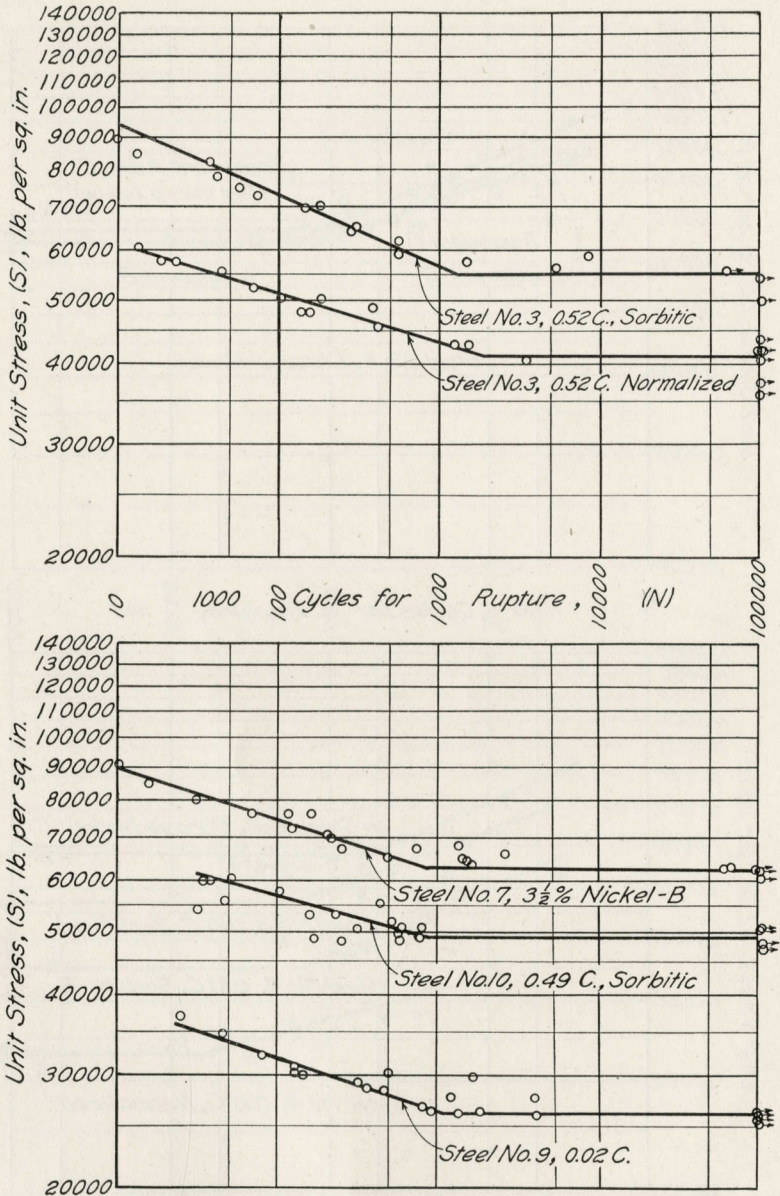

FIG. 26. S-N DIAGRAMS FOR 0.52 CARBON STEEL, 0.49 CARBON STEEL, 0.02 CARBON STEEL, AND 3.5 NICKEL STEEL, ROTATING-BEAM TESTS
Logarithmic abscissas give thousands of cycles for rupture

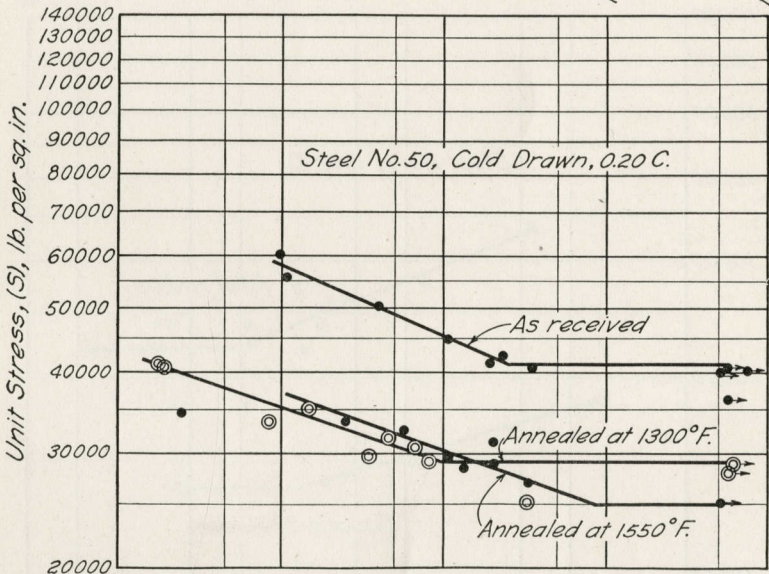
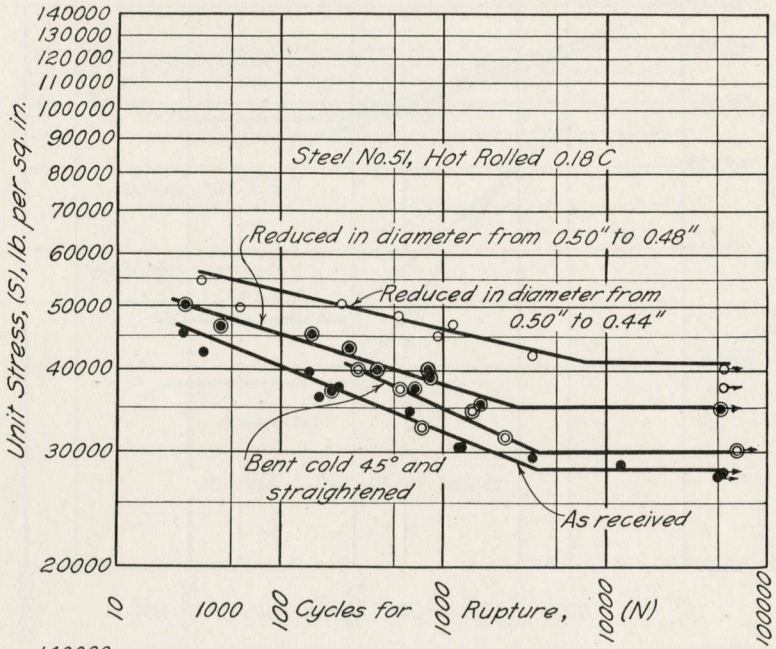

FIG. 27. S-N DIAGRAMS FOR HOT-ROLLED STEEL AND FOR COLD-DRAWN STEEL, ROTATING-BEAM TESTS

Logarithmic abscissas give thousands of cycles for rupture

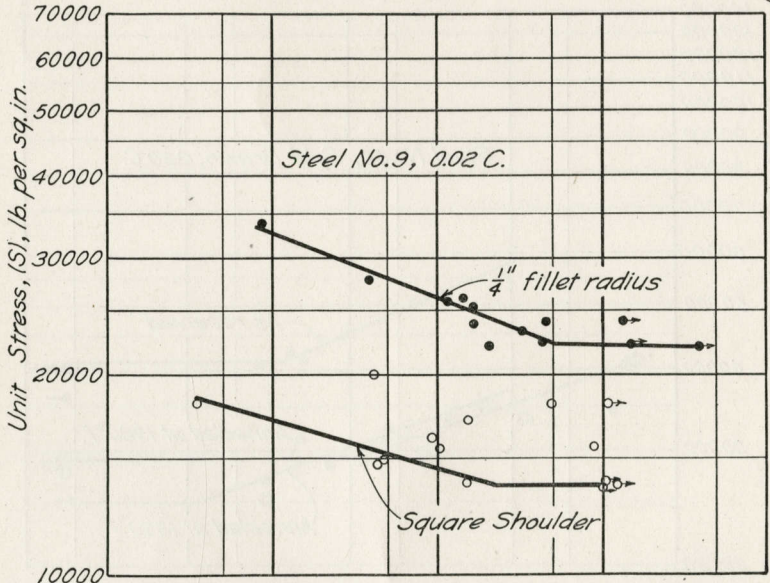
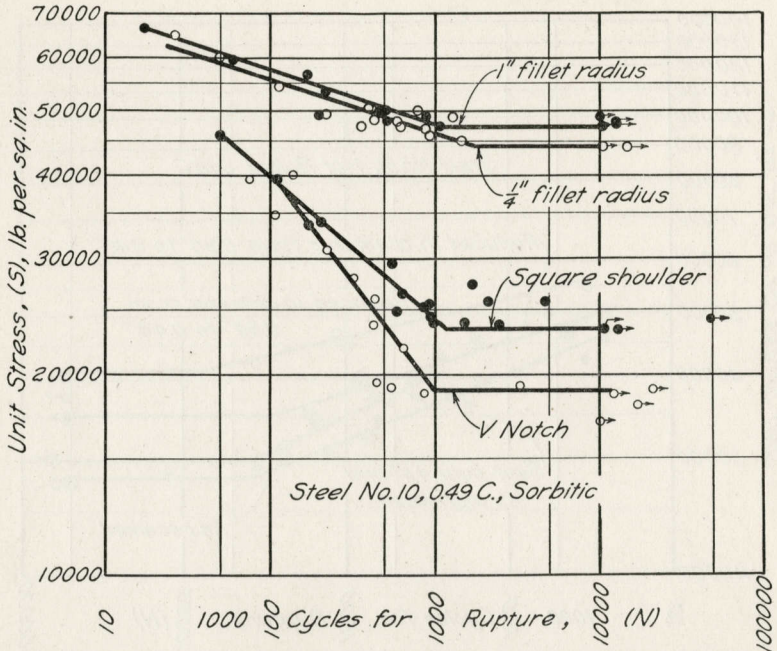

FIG. 28. S-N DIAGRAMS SHOWING EFFECT OF SHAPE OF SPECIMEN, ROTATING-BEAM TESTS
 Logarithmic abscissas give thousands of cycles for rupture

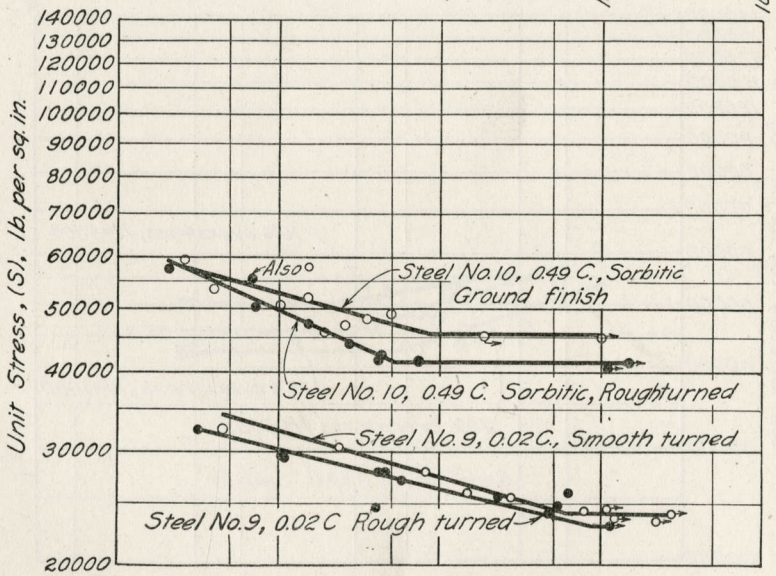
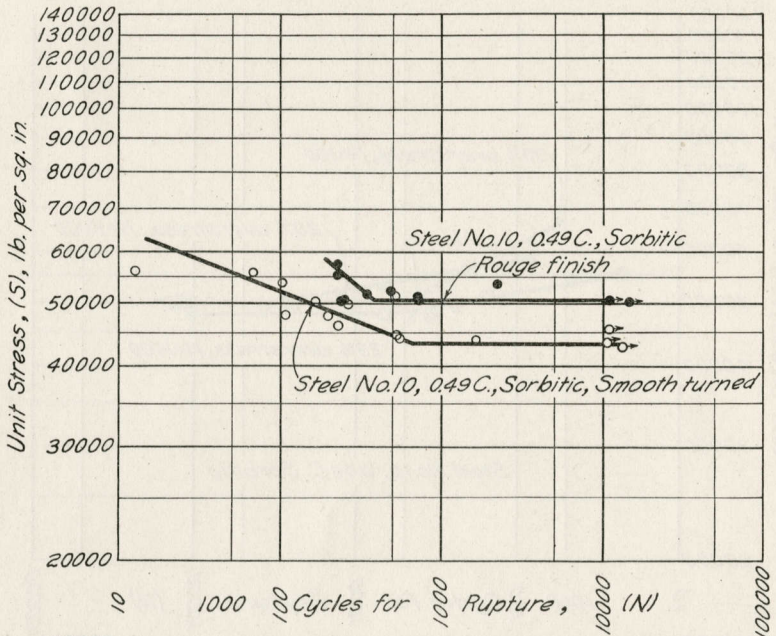

FIG. 29. S-N DIAGRAMS SHOWING EFFECT OF SURFACE FINISH, ROTATING-BEAM TESTS

Logarithmic abscissas give thousands of cycles for rupture

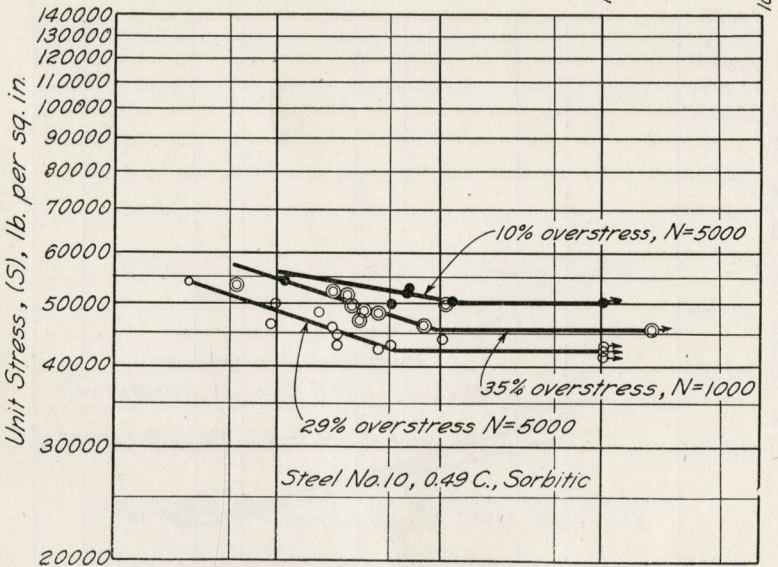
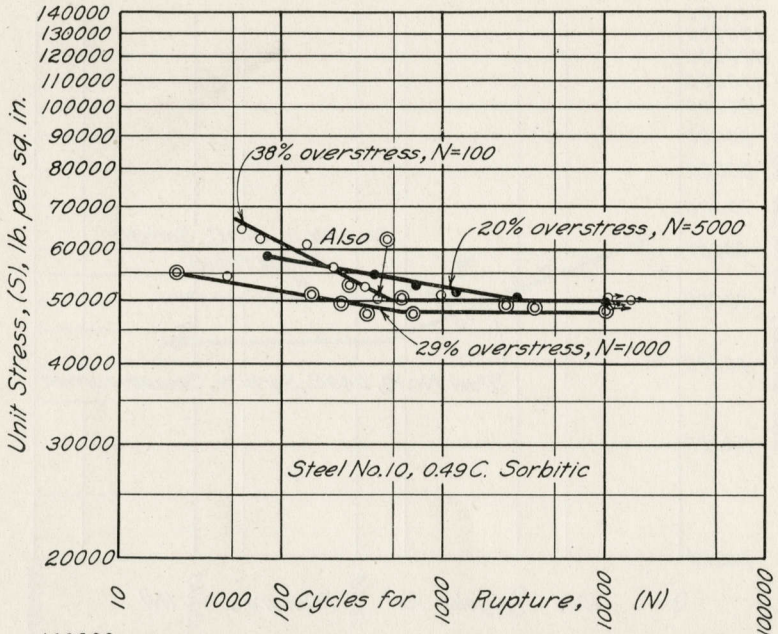

FIG. 30. S-N DIAGRAMS SHOWING EFFECT OF OVERSTRESS, 0.49 CARBON STEEL, ROTATING-BEAM TESTS

Logarithmic abscissas give thousands of cycles for rupture

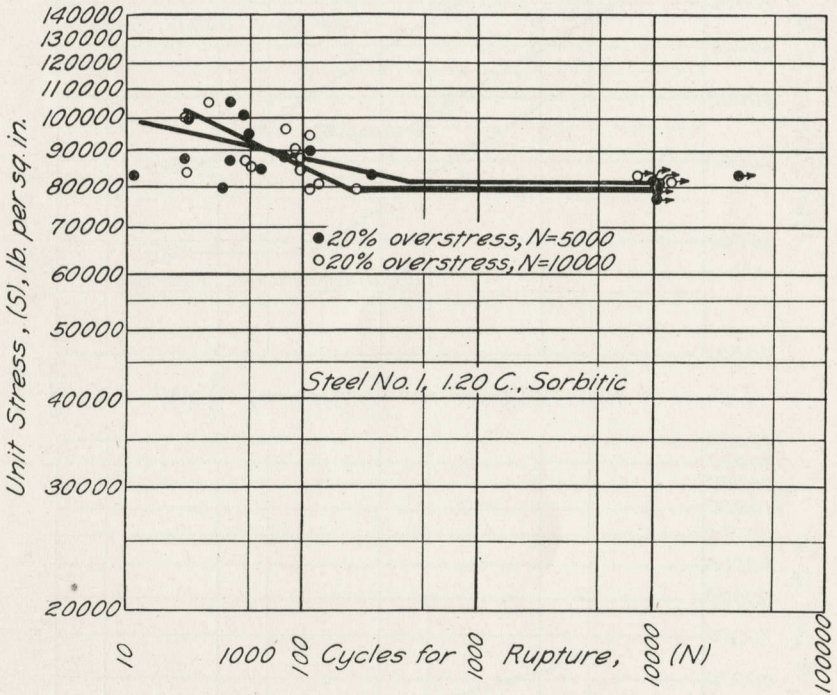

FIG. 31. S-N DIAGRAMS SHOWING EFFECT OF OVERSTRESS, 1.20 CARBON STEEL, ROTATING-BEAM TESTS

Logarithmic abscissas give thousands of cycles for rupture

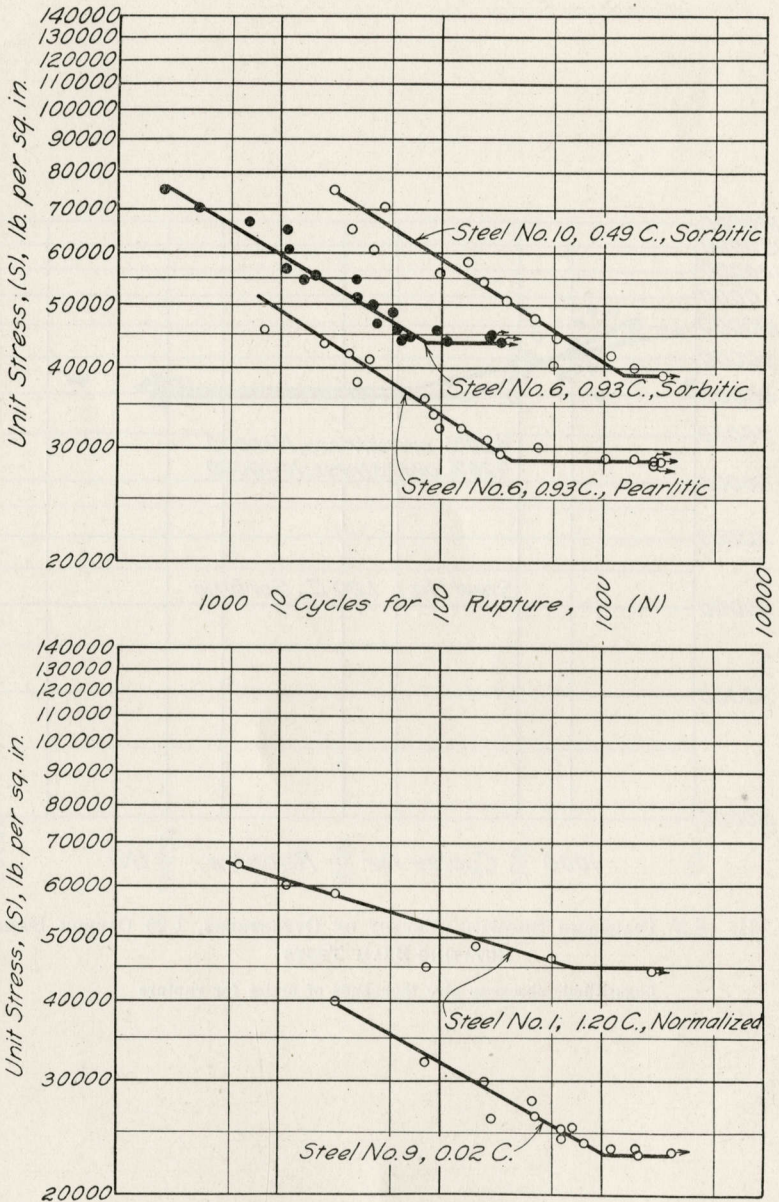

FIG. 32. S-N DIAGRAMS, UPTON-LEWIS TESTS, 0.93 CARBON STEEL, 1.20 CARBON STEEL, 0.49 CARBON STEEL, AND 0.02 CARBON STEEL
 Logarithmic abscissas give thousands of cycles for rupture

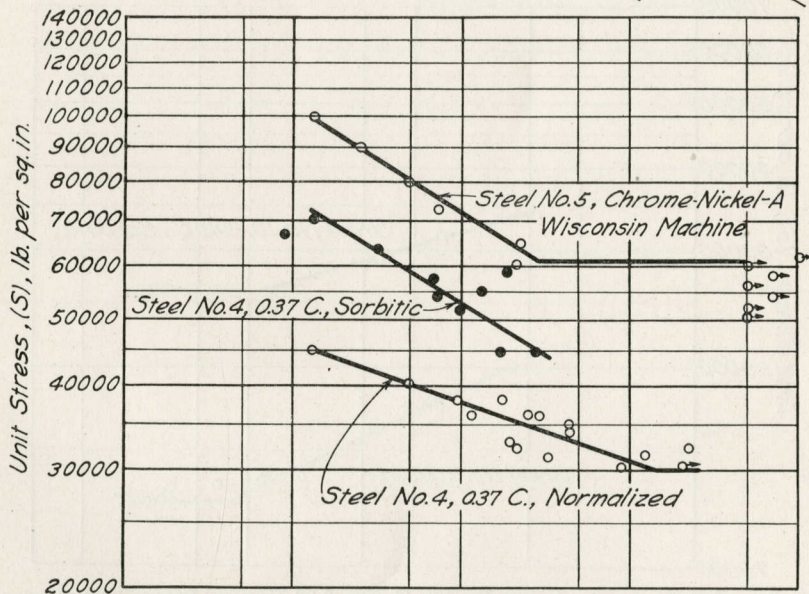
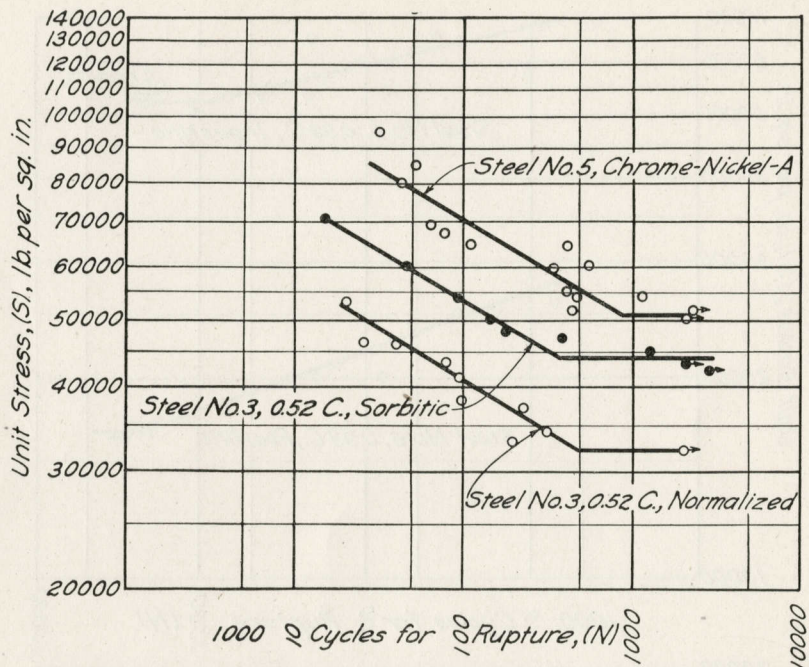

FIG. 33. S-N DIAGRAMS, UPTON-LEWIS TESTS, 0.52 CARBON STEEL, 0.37 CARBON STEEL, AND CHROME-NICKEL STEEL: TESTS ON WISCONSIN MACHINE, CHROME-NICKEL STEEL

Logarithmic abscissas give thousands of cycles for rupture

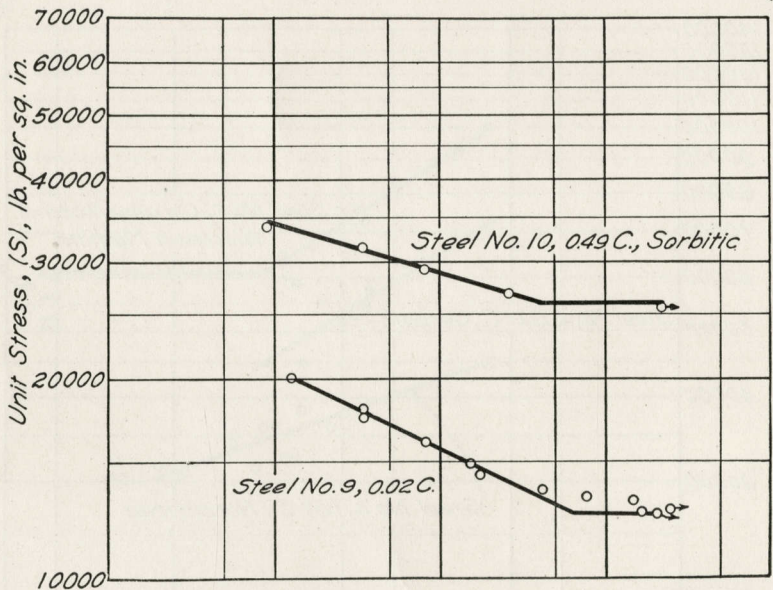
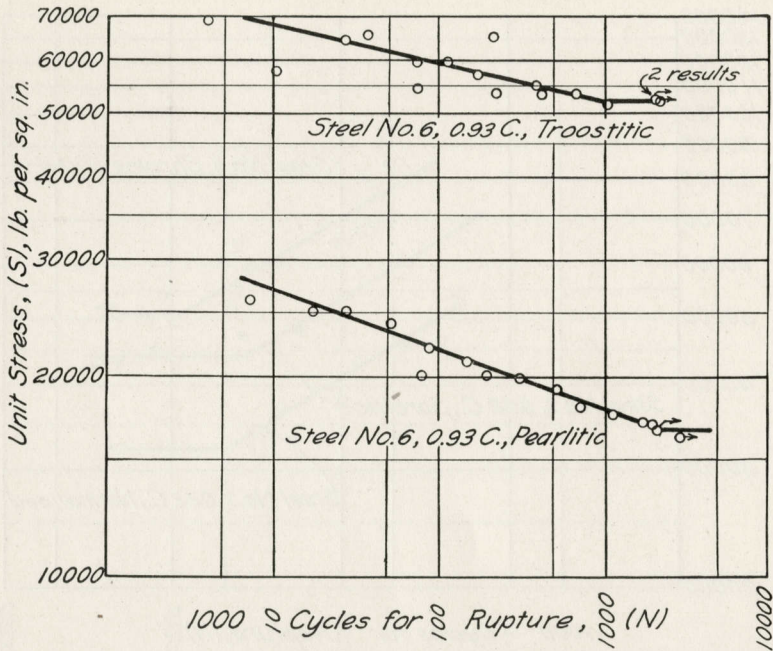

FIG. 34. S-N DIAGRAMS, OLSEN-FOSTER TESTS, 0.93 CARBON STEEL, 0.02 CARBON STEEL, AND 0.49 CARBON STEEL

Logarithmic abscissas give thousands of cycles for rupture

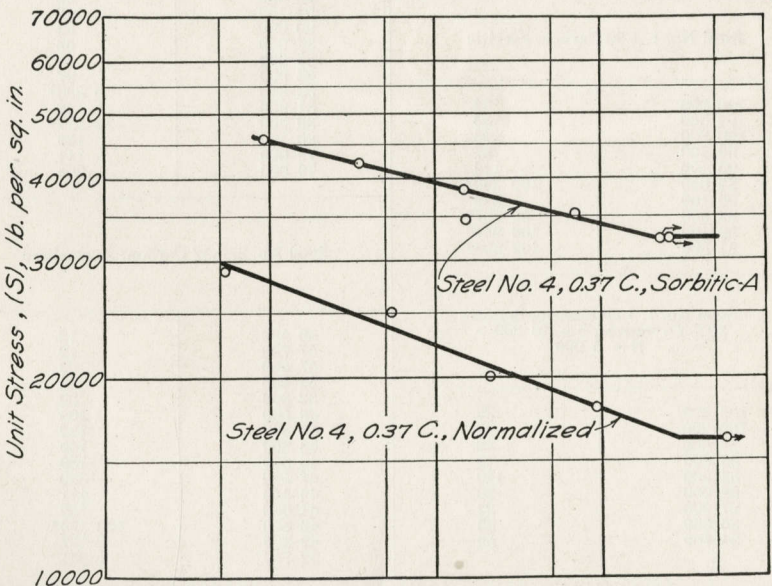
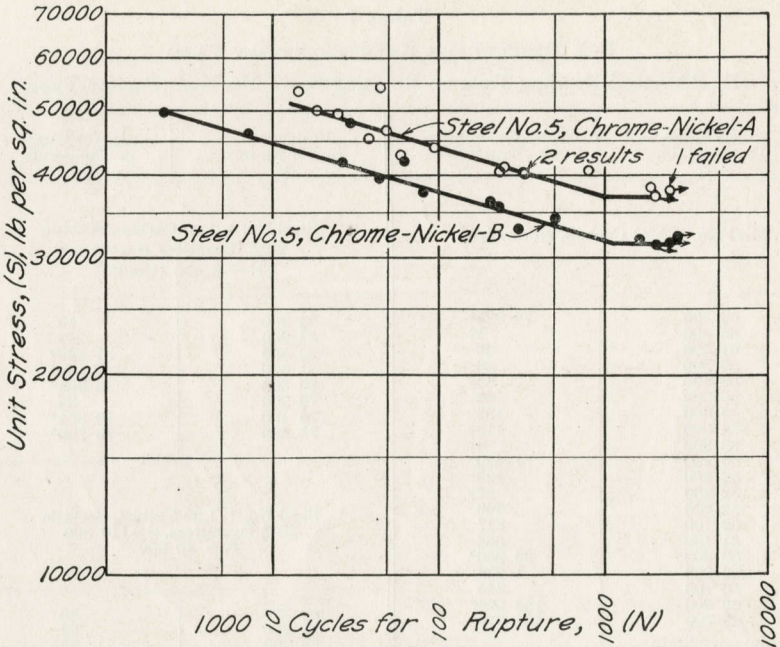

FIG. 35. S-N DIAGRAMS, OLSEN-FOSTER TESTS, 0.37 CARBON STEEL, AND CHROME-NICKEL STEEL

Logarithmic abscissas give thousands of cycles for rupture

TABLE 7 (Continued)

S-N RESULTS FOR REVERSED-STRESS TESTS

(I) Reversed-Bending Tests of Rotating-Beam Machine (Farmer Type)

Unit Stress lb. per sq. in. S	Cycles for Rupture in Thousands N	Unit Stress lb. per sq. in. S	Cycles for Rupture in Thousands N
Steel No. 3, 0.52 Carbon, Normalized (Cont'd)		Steel No. 4, 0.37 Carbon, Normalized (Cont'd)	
42 200	4 124†	35 700	1 572
41 900	100 000*	35 400	1 536
41 600	100 168*	35 100	3 154
41 900	112 944*	35 100	4 463
40 400	3 544	34 700	8 478
40 400	102 332*	33 900	106 588*
37 300	102 738*	33 900	107 569*
35 800	100 614*	33 800	9 937
		33 200	103 602*
		33 100	3 248
		32 000	101 415*
Steel No. 3, 0.52 Carbon, Sorbitic		Steel No. 4, 0.37 Carbon, Sorbitic Treatment A	
89 800	10	81 400	44
85 000	13	74 700	85
82 200	37	71 600	136
78 100	40	64 700	631
75 400	57	62 100	1 926
73 000	73	59 600	292
70 200	183	58 800	641
69 500	148	58 700	1 364
65 500	303	57 200	100 965*
64 000	282	56 200	94 060*
62 000	562	55 600	90 179*
59 000	559		
58 400	8 790		
57 500	1 527		
56 200	5 540		
55 800	63 265*		
54 100	103 387*		
49 800	108 987*		
Steel No. 4, 0.37 Carbon, Normalized		Steel No. 4, 0.37 Carbon, Sorbitic Treatment B	
49 100	1†	80 000	3
48 800	0†	69 900	6
45 100	90	64 100	35
43 900	4†	63 000	180
42 200	4†	60 200	108
42 000	234	59 800	144
40 400	572	57 200	262
40 000	0†	55 100	237
40 000	4†	52 600	373
40 000	1 861	50 500	2 103
39 900	17†	50 000	101 403*
38 100	280	49 000	585
38 100	457	47 200	766
38 100	1 175	47 100	101 566*
37 700	2 027	45 300	56 550
37 300	1 667	44 200	108 518*
36 600	770	40 300	100 456*
36 200	884		

* Specimen did not break.

† Specimen bent.

TABLE 7 (Continued)

S-N RESULTS FOR REVERSED-STRESS TESTS

(I) Reversed-Bending Tests of Rotating-Beam Machine (Farmer Type)

Unit Stress lb. per sq. in. S	Cycles for Rupture in Thousands N	Unit Stress lb. per sq. in. S	Cycles for Rupture in Thousands N
Steel No. 5, Chrome-Nickel, Treatment A		Steel No. 5, Chrome-Nickel, Treatment C	
120 000	5	102 100	4
111 300	6	95 100	31
105 300	13	86 000	56
100 100	30	80 800	127
95 200	59	75 000	180
89 800	76	72 600	248
85 800	230	70 600	405
83 100	95	69 800	3 514
80 800	168	68 800	1 027
79 600	212	68 300	1 209
77 600	306	67 500	818
76 900	289	67 500	68 441
75 600	1 305	67 500	100 662*
75 300	807	67 300	817
73 100	765	66 500	58 281
70 200	945		
69 200	298		
68 800	99 908*		
68 600	272		
68 500	824		
68 200	829		
68 000	1 360		
67 800	100 735*		
67 200	105 669*		
65 200	101 602*		
65 200	83 364		
62 800	101 239*		
Steel No. 5, Chrome-Nickel, Treatment B		Steel No. 6, 0.93 Carbon, Pearlitic	
89 800	25	48 800	15
86 000	30	44 500	24
83 000	94	42 000	36
77 700	88	40 000	80
74 700	186	38 100	177
74 700	223	36 900	162
70 100	405	35 700	301
67 900	810	34 200	290
65 900	907	33 400	361
65 500	1 818	32 800	643
65 200	1 227	32 200	881
65 200	2 962	31 100	1 302
64 700	34 314	30 800	662
64 500	102 200*	30 800	2 270
64 500	103 979*	30 500	100 125*
		30 500	103 677*
		30 300	101 190*
		29 900	101 176*
		29 900	102 483*

* Specimen did not break.

† Specimen bent.

TABLE 7 (Continued)

S-N RESULTS FOR REVERSED-STRESS TESTS

(I) Reversed-Bending Tests of Rotating-Beam Machine (Farmer Type)

Unit Stress lb. per sq. in. S	Cycles for Rupture in Thousands N	Unit Stress lb. per sq. in. S	Cycles for Rupture in Thousands N
Steel No. 9, 0.02 Carbon, as Received (Cont'd)		Steel No. 9, 0.02 Carbon, Square Shoulder	
26 200	2†	23 300	0†
26 200	944	22 000	0†
26 200	1 869	20 000	408
26 100	104 506*	18 600	416†
26 000	1 392	18 200	35†
25 900	4 251	18 100	4 912
25 900	100 576*	18 100	10 774*
25 400	104 871*	17 100	1 551
25 100	104 175*	16 000	914
		15 500	1 019
		15 500	8 891
		14 800	470
		14 700	434
		14 200	295†
		13 600	1 492
		13 600	12 828*
		13 600	12 234*
		13 400	10 000*
		13 700	10 077*
Steel No. 9, 0.02 Carbon, Rough Turned		Steel No. 9, 0.02 Carbon, 1/4" Radius	
32 300	31	34 000	87
29 700	104	32 300	4†
29 200	110	28 700	14†
27 900	406	27 800	393
27 900	453	27 000	22†
27 200	576	26 000	1 418
25 900	6 329	25 800	1 116
25 600	2 291	25 300	1 615
25 000	434†	24 500	46†
24 900	5 424	24 000	4 646
24 600	407	24 000	13 486*
24 100	578†	23 800	1 625
24 000	4 836	23 300	3 251
23 100	11 372*	22 800	4 378
		22 300	173†
		22 200	15 129*
		22 000	2 062
		22 000	39 129*
Steel No. 9, 0.02 Carbon, Smooth Turned		Steel No. 10, 0.49 Carbon, Sorbitic	
33 500	4†	64 500	2†
32 300	45	64 400	18†
30 300	236	62 000	5†
27 900	806	60 300	52†
25 900	1 480	60 000	38
25 400	2 756	59 900	35
24 900	2 042†		
24 400	7 781		
24 400	10 880*		
24 000	899†		
24 000	25 936*		
23 600	2 325†		
23 600	12 256*		
23 500	21 937*		

* Specimen did not break.

† Specimen bent.

TABLE 7. (Continued)

S-N RESULTS FOR REVERSED-STRESS TESTS

(I) Reversed-Bending Tests of Rotating-Beam Machine (Farmer Type)

Unit Stress lb. per sq. in. S	Cycles for Rupture in Thousands N	Unit Stress lb. per sq. in. S	Cycles for Rupture in Thousands N
Steel No. 10, 0.49 Carbon, Sorbitic, V-Notch		Steel No. 10, 0.49 Carbon, Sorbitic, 1" Radius (Cont'd)	
40 000	154	49 000	896
39 500	76	48 500	521
34 900	110	48 100	12 793*
30 900	228	48 000	12 669*
28 200	331	47 500	1 110
26 000	441	47 500	10 223*
23 700	431		
21 900	670		
19 400	459		
19 200	3 393		
19 100	557		
19 000	21 800*		
18 800	887		
18 800	12 480*		
18 000	17 634*		
16 900	10 090*		
Steel No. 10, 0.49 Carbon, Sorbitic, 1/4" Radius			
65 400	26	67 000	2†
60 100	49	65 700	3†
54 500	117	64 700	57
50 800	800	62 500	75
50 700	398	61 100	144
49 400	221	57 900	36†
49 000	1 298	56 400	212
48 600	427	54 300	45
48 200	582	52 600	337
47 600	618	51 100	1 000
47 500	361	50 800	10 220*
47 000	882	50 500	398
46 100	926	50 000	14 440*
45 100	1 416	49 500	10 687*
44 100	10 639*		
44 000	15 072*		
Steel No. 10, 0.49 Carbon, Sorbitic, 1" Radius			
66 900	17		
64 000	43		
59 800	60		
56 800	168		
54 300	117		
53 500	220		
50 100	505		
50 000	452		
49 500	195		
49 100	10 086*		
Steel No. 10, 0.49 Carbon, Sorbitic, 35% Over- stress, N = 1000, S = 65 000			
		56 600	8†
		53 700	57
		52 400	224
		51 800	274
		50 000	1 162
		49 800	294
		49 000	352
		48 600	426
		47 200	328
		46 500	819
		45 900	2†
		45 800	20 986*
		45 600	147
Steel No. 10, 0.49 Carbon, Sorbitic, 29% Over- stress, N = 1000, S = 62 000			
		60 000	4
		55 000	22
		52 900	261
		51 100	155
		50 800	564

* Specimen did not break.

† Specimen bent.

TABLE 7 (Continued)

S-N RESULTS FOR REVERSED-STRESS TESTS

(I) Reversed-Bending Tests of Rotating-Beam Machine (Farmer Type)

Unit Stress lb. per sq. in. S	Cycles for Rupture in Thousands N	Unit Stress lb. per sq. in. S	Cycles for Rupture in Thousands N
Steel No. 10, 0.49 Carbon, Sorbitic, 29% Overstress, N = 1000, S = 62 000 (Cont'd)		Steel No. 50, Cold-drawn, as Received	
50 300	392	70 000	6
49 500	236	60 300	97
49 300	2 430	55 600	108
49 000	3 279	50 300	397
48 400	10 140*	45 000	1 073
47 800	340	42 200	2 284
47 800	650	41 100	1 958
		40 700	56 976*
		40 400	3 480
		40 300	8 919
		40 000	74 956*
		40 000	51 376*
		36 200	57 606*
Steel No. 10, 0.49 Carbon, Sorbitic, 29% Overstress, N = 5000, S = 62 000		Steel No. 50, Cold-drawn, Annealed at 1300° F.	
54 000	28	41 200	18
50 000	100	40 800	19
48 800	183	35 000	147
47 200	29†	33 500	84
46 500	90	31 600	457
46 000	221	30 500	680
44 900	234	29 700	356
44 100	1 091	29 000	818
43 100	10 738*	28 900	61 754*
43 100	514	27 900	59 628*
42 900	238	25 600	5 289†
42 700	433	25 000	3 229
42 300	10 057*		
41 800	10 620*		
Steel No. 10, 0.49 Carbon, Sorbitic, 20% Overstress, N = 5000, S = 60 600		Steel No. 50, Cold-drawn, Annealed at 1550° F.	
58 500	84	34 700	25
55 000	383	33 400	248
52 900	684	32 500	571
51 300	1 220	31 200	2 042
50 500	2 883	29 500	1 099
49 800	10 022*	28 900	2 059
		28 200	1 380
		26 900	3 371
		25 100	52 244*
Steel No. 10, 0.49 Carbon, Sorbitic, 10% Overstress, N = 5000, S = 55 600			
54 300	116		
53 100	662		
52 100	643		
50 500	510		
50 500	1 220		
50 500	10 554*		

* Specimen did not break.

† Specimen bent.

TABLE 7. (Continued)

S-N RESULTS FOR REVERSED-STRESS TESTS

(I) Reversed-Bending Tests of Rotating-Beam Machine (Farmer Type)

Unit Stress lb. per sq. in. S	Cycles for Rupture in Thousands N	Unit Stress lb. per sq. in. S	Cycles for Rupture in Thousands N
Steel No. 51, Hot-rolled, 0.18 Carbon, as Received		Steel No. 51, Hot-rolled, 0.18 Carbon, Reduced from $\frac{1}{2}$ in. to 0.48 in.	
45 400	24	50 100	25
42 300	33	46 700	42
42 100	7†	45 200	154
39 700	148	43 100	260
37 700	221	40 000	385
36 200	172	40 000	795
34 600	602	39 000	841
30 300	1 244	37 700	671
30 300	1 292	37 000	203
29 200	4 631	35 800	1 712
28 600	12 452	34 800	52 383*
27 800	53 926*		
27 300	50 905*		
Steel No. 51, Hot-rolled, 0.18 Carbon, Reduced from $\frac{1}{2}$ in. to 0.44 in.		Steel No. 51, Hot-rolled, 0.18 Carbon, Bent Cold and Straightened	
54 700	32†	49 800	3†
50 500	230	45 300	1†
49 800	55	37 300	546
48 300	524	34 700	1 504
47 000	1 178	32 500	726
45 200	911	31 400	2 384
42 200	3 519	30 000	65 198*
40 000	53 537*		
40 000	53 582*		
37 600	53 826*		

* Specimen did not break.

† Specimen bent.

TABLE 7 (Continued)

S-N RESULTS FOR REVERSED-STRESS TESTS

(II) Reversed-Bending Tests on Upton-Lewis Machine

Unit Stress lb. per sq. in. S	Cycles for Rupture in Thousands N	Unit Stress lb. per sq. in. S	Cycles for Rupture in Thousands N
Steel No. 1, 1.20 Carbon, Normalized		Steel No. 4, 0.37 Carbon, Sorbitic	
65 000	6	70 700	13
60 000	11	66 700	9
58 400	23	64 300	32
48 600	167	58 900	186
46 700	495	57 800	69
45 000	81	54 800	131
44 200	2 047*	54 200	71
		51 600	98
		44 800	272
		44 700	168
Steel No. 3, 0.52 Carbon, Normalized		Steel No. 5, Chrome-nickel, Treatment A	
53 300	20	95 200	31
46 500	26	85 100	52
46 000	40	80 000	42
43 300	79	69 300	64
41 200	95	67 800	78
38 000	98	64 800	111
37 000	225	64 400	413
34 200	315	60 100	558
33 000	195	59 700	340
32 000	2 017*	55 100	406
		54 200	1 182
		54 100	469
		53 200	444
		51 600	2 307*
		50 200	2 017*
Steel No. 3, 0.52 Carbon, Sorbitic		Steel No. 6, 0.93 Carbon, Pearlitic	
70 700	15	45 600	8
60 000	46	43 300	19
54 000	93	41 900	26
50 000	143	41 000	35
48 000	179	37 800	30
47 000	392	35 800	78
45 000	1 323	33 700	89
43 000	2 086*	32 000	97
42 000	2 928*	30 800	190
		30 000	393
		29 200	228
		28 900	1 027
		28 900	1 582
		28 600	2 018*
		28 000	2 011*
		28 600	2 359*
Steel No. 4, 0.37 Carbon, Normalized			
45 000	13		
40 000	49		
38 200	178		
38 000	96		
36 000	113		
36 000	248		
35 900	289		
34 800	429		
34 000	446		
32 800	196		
32 000	214		
32 000	2 226		
31 200	1 224		
31 000	330		
30 200	2 007*		
30 000	895		

* Specimen did not break.

† Specimen bent.

TABLE 7 (Continued)

S-N RESULTS FOR REVERSED-STRESS TESTS
(II) Reversed-Bending Tests on Upton-Lewis Machine

Unit Stress lb. per sq. in. S	Cycles for Rupture in Thousands N	Unit Stress lb. per sq. in. S	Cycles for Rupture in Thousands N
Steel No. 6, 0.93 Carbon, Sorbitic		Steel No. 10, 0.49 Carbon, Sorbitic	
75 500	19	75 500	21
70 500	31	70 500	43
67 200	64	65 600	27
65 400	112	60 500	37
60 900	112	58 100	142
56 900	107	55 900	95
55 200	162	54 200	180
54 800	294	50 500	245
54 600	139	47 500	368
51 100	294	44 200	517
49 100	364	41 800	1 115
48 400	492	40 300	489
46 700	392	40 000	1 567
45 600	916	39 000	2 309*
45 400	524		
44 800	2 656*		
44 800	1 084		
44 300	625		
44 200	1 993*		
43 600	2 326*		
Steel No. 9, 0.02 Carbon, as Received			
39 800	22		
32 000	81		
29 900	187		
27 900	374		
26 400	394		
26 100	211		
25 400	661		
25 000	563		
24 400	563		
24 000	780		
23 600	1 614		
23 600	1 175		
23 300	2 723*		
23 000	1 694		

* Specimen did not break,

† Specimen bent,

TABLE 7 (Continued)

S-N RESULTS FOR REVERSED-STRESS TESTS

(III) Reversed-Bending Tests on Rotating-Beam Machine (Wisconsin)

Unit Stress lb. per sq. in. S	Cycles for Rupture in Thousands N	Unit Stress lb. per sq. in. S	Cycles for Rupture in Thousands N
Steel No. 5, Chrome-Nickel, Treatment A		Steel No. 2, Wisconsin Tests	
99 900	14	50 000	54
89 900	26	45 100	222
80 200	49	42 600	476
72 800	74	39 900	758
65 200	224	39 500	1 783
62 000	10 623*	39 100	450
60 100	216	39 000	903
60 000	5 231*	38 000	10 486*
58 100	7 215*	37 000	12 102*
56 100	5 222*	34 900	12 642*
54 000	7 250*		
52 000	5 122*		
50 300	5 193*		
Steel No. 1, Wisconsin Tests		Steel No. 3, Wisconsin Tests	
45 000	118	59 600	42
42 000	238	53 100	96
39 900	331	50 000	180
39 900	164	47 500	403
39 000	600	45 000	539
39 000	415	44 900	467
38 600	517	44 000	5 828
37 000	630	43 000	3 031
36 000	1 317	43 000	670
36 000	1 076	42 000	10 549*
35 200	12 446*	42 000	20 833*
34 900	806	42 100	15 716*
34 900	1 940		
34 000	1 916		
34 000	3 608		
34 000	4 857		
33 500	4 790		
33 500	10 662*		
33 100	10 759*		
32 500	14 173*		
30 000	14 984*		

* Specimen did not break,

† Specimen bent.

TABLE 7 (Continued)

S-N RESULTS FOR REVERSED-STRESS TESTS

(IV) Reversed-Torsion Tests on Olsen-Foster Machine

Unit Stress lb. per sq. in. S	Cycles for Rupture in Thousands N	Unit Stress lb. per sq. in. S	Cycles for Rupture in Thousands N
Steel No. 4, 0.37 Carbon, Normalized		Steel No. 5, Chrome-Nickel, Treatment B	
29 000	5	49 700	2
25 000	54	46 000	7
20 000	207	41 900	27
18 000	937	42 000	62
16 000	5 492*	39 500	44
Steel No. 4, 0.37 Carbon, Sorbitic		37 900	81
45 800	10	36 400	208
42 200	34	35 900	234
38 500	146	34 200	512
35 200	606	33 100	304
34 700	153	32 200	2 804*
32 400	2 000*	32 000	1 660
32 400	2 318*	31 300	2 565*
Steel No. 5, Chrome-Nickel, Treatment A		31 200	2 117*
54 100	44		
53 800	14		
50 200	18		
49 600	25		
46 800	49		
45 200	38		
43 800	94		
43 000	58		
41 000	250		
40 500	236		
40 000	337		
40 000	325		
38 100	1 906		
37 900	2 544*		
37 900	2 550*		
37 000	2 064*		

* Specimen did not break.

† Specimen bent.

TABLE 7 (Continued)

S-N RESULTS FOR REVERSED-STRESS TESTS

(IV) Reversed-Torsion Tests on Olsen-Foster Machine

Unit Stress lb. per sq. in. S	Cycles for Rupture in Thousands N	Unit Stress lb. per sq. in. S	Cycles for Rupture in Thousands N
Steel No. 6, 0.93 Carbon, Pearlitic		Steel No. 9, 0.02 Carbon, as Received	
26 000	7	20 000	13
25 000	18	18 000	35
24 000	52	17 300	34
22 000	87	16 000	82
21 000	147	14 900	157
20 000	79	14 300	178
20 000	196	13 500	420
19 800	305	13 200	780
19 000	509	13 000	1 505
18 000	703	12 700	2 446*
17 500	1 149	12 500	1 632
17 000	1 742	12 400	2 062*
16 800	1 926		
16 500	2 000*		
16 100	2 880*		
Steel No. 6, 0.93 Carbon, Troostitic		Steel No. 10, 0.49 Carbon, Sorbitic	
77 500	4	34 000	9
68 600	4	31 600	34
65 500	37	29 200	82
65 200	215	26 900	266
64 200	27	25 600	2 206*
59 500	74		
57 700	11		
57 200	173		
54 800	389		
53 500	685		
53 200	220		
53 100	418		
52 500	2 039*		
52 400	2 045*		
52 100	2 198*		
51 400	1 059		

* Specimen did not break.

† Specimen bent.

IV. DISCUSSION OF RESULTS

14. *Endurance Limit*.—The question whether any material can withstand an infinite number of repetitions of stress, however small, cannot of course be answered by direct experimentation. Earlier investigators determined a "limit" from plotted curves with values of unit stresses as ordinates, and numbers of repetitions of stress causing failure as abscissas. Denoting values of unit stress by S and number of cycles of stress necessary to cause failure by N , such diagrams may be conveniently designated as S - N diagrams, and are so designated in this bulletin. Having drawn such a diagram, the early experimenters then judged as best they could where the S - N diagram became horizontal, and took the S ordinate corresponding to this horizontal asymptote as the limiting stress which could be withstood an indefinite number of times. Fig. 36(A) shows some of the test data of this investigation plotted in this way. A careful reading of the writings of early investigators shows that they recognized the limitations of this method and the enormous extrapolation involved.

A modification of this method is to plot values of S as ordinates and values of the reciprocal of N as abscissas. (See Fig. 36 [B] in which some of the test data of this investigation are thus plotted). Then the limit for indefinite repetition of stress is found by extending the curve backward until it crosses the zero line of abscissas. This method involves an extrapolation which apparently is only slight, but which in reality is as great as that involved in the first method. In Fig. 36(B) the horizontal distance between A , corresponding to the smallest observed value of $1/N$, and the zero line for $1/N$ seems small, but in reality it corresponds to an infinite distance along the N -axis in the S - N diagram, Fig. 36(A). This method of plotting gives no assurance that the reciprocal S - N diagrams do not follow the broken lines in Fig. 36(B).

A modification of this second method, suggested by Mr. C. E. Stromeyer of Manchester, England, involves plotting values of S against values of $\frac{1}{\sqrt[4]{N}}$. This method gives a graph which is nearly

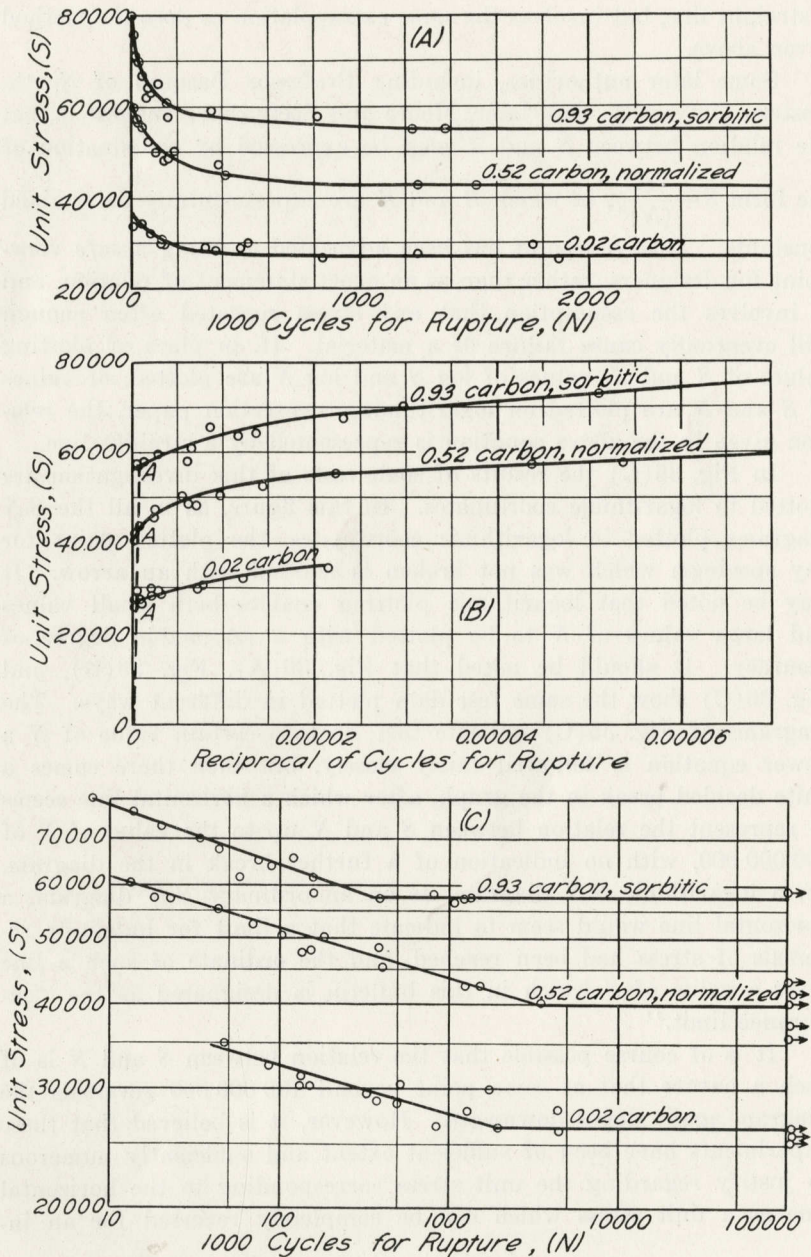

FIG. 36. VARIOUS METHODS OF PLOTTING S-N DIAGRAMS

a straight line, but involves the same extrapolation as does the method given above.

Some later authorities, including Professor Basquin of Northwestern University, and, later, Moore and Seely, have suggested that the relation between S and N may be expressed by an equation of the form $S = \frac{B}{(N)^K}$, in which B and K are experimentally determined constants. This viewpoint has been advocated as being a *safe* viewpoint for designers, rather than as an exact statement of relation, and it involves the assumption that any stress repeated often enough will eventually cause failure of a material. If, in place of plotting values of S and N , values of $\log S$ and $\log N$ are plotted, or values of S and N are plotted on logarithmic cross-section paper, the relation given in the above equation is represented by a straight line.

In Fig. 36(C) the results of some tests of this investigation are plotted to logarithmic coördinates. In this figure, as in all the S - N diagrams plotted to logarithmic coördinates, the plotted point for any specimen which was not broken is marked with an arrow. It may be noted that logarithmic plotting enables both small values and large values of N to be plotted with a reasonable degree of accuracy. It should be noted that Fig. 36(A), Fig. 36(B), and Fig. 36(C) show the same test data plotted in different ways. The diagrams of Fig. 36(C) indicate that up to a certain value of N a power equation is followed fairly closely, but then there comes a quite decided break in the graph, after which a horizontal line seems to represent the relation between S and N up to the value of N of 100 000 000, with no indication of a further break in the diagram. On a logarithmic S - N diagram, as on an ordinary S - N diagram, a horizontal line would seem to indicate that a limit for indefinite reversals of stress had been reached, and the ordinate of such a line gives a value of S which in this bulletin is designated as the "endurance limit."

It is of course possible that the relation between S and N is of such a nature that at some point beyond 100 000 000 reversals the diagram again slopes downward. However, it is believed that these experiments have been of sufficient extent and sufficiently numerous to justify regarding the unit stress corresponding to the horizontal line as a unit stress which can be completely reversed for an in-

definite number of times without danger of failure and in calling that unit stress the endurance limit. Additional confidence in this conclusion is given by the well-defined "break" shown in the logarithmic $S-N$ diagrams, indicating as it does a decided change in the relation between S and N ; and still further confidence is given by the distinct rise of temperature noted at the endurance limit (this rise of temperature is more fully discussed in Chapter V).

Some of the $S-N$ diagrams show considerable variation in values of N for a given value of S , especially at or near the endurance limit. The engineer usually wishes to determine a safe value of S , and it may be pointed out that for these same $S-N$ diagrams there is little variation in S for a given value of N .

It is believed that the series of tests herein reported furnish a clearer demonstration of the existence and magnitude of an endurance limit for steel than has been furnished by previous tests. It is believed, moreover, that this investigation is a reconnaissance in the field of wrought ferrous metals sufficiently extensive to indicate the probability that there is an endurance limit for such metals in general.

In all of the curves the endurance limit is developed at a value of N less than 10 000 000. This fact can be used to shorten very greatly the time required for determining the endurance limit of ferrous metals. It is not at all certain that non-ferrous metals reach their endurance limits at such low values of N .

15. *Some Factors Influencing Endurance Limit.*—Fig. 24 illustrates the effect of heat treatment on the endurance limit. The very soft condition of the pearlitic structure of the 0.93 carbon steel results in an endurance limit of 30 500 pounds per square inch. This can be increased 84 per cent when the steel is given a sorbitic structure by heat treatment, and 221 per cent when it is given a troostitic structure. Figs. 25 and 26 illustrate the same fact and make clear the very great influence which heat treatment may exert upon the fatigue strength of steel.

Figs. 32 and 33 show the $S-N$ curves obtained with the Upton-Lewis reversed-bending machine, and also one curve for chrome-nickel steel, treatment A, which is from tests made on the Wisconsin machine. The endurance limits from these tests on the Upton-Lewis

machine are given in Table 5, and it will be noted that they are uniformly lower than those obtained from the rotating-beam test. This difference is probably due in part to stresses set up by the inertia of vibrating parts in the Upton-Lewis machine, and in part to the fact that a $\frac{1}{2}$ -inch radius was used in reducing the section of the Upton-Lewis specimen, while a radius of 9.85 inches was used in the case of the rotating-beam specimen. It is well known that an abrupt change of section such as employed with the Upton-Lewis specimen causes localized stresses which tend to reduce the fatigue strength. This matter is discussed more fully in Section 20, "Effect of Shape of Specimen on Endurance."

For steel No. 5, chrome-nickel, treatment A, the endurance limit was determined with three different machines. The corresponding *S-N* diagrams are shown in Figs. 25 and 33. The Farmer machine gave an endurance limit of 68 000 pounds per square inch, the Wisconsin machine an endurance limit of 61 000 pounds per square inch, and the Upton-Lewis machine an endurance limit of 52 000 pounds per square inch. The two lower values in the Wisconsin and the Upton-Lewis machines, respectively, are believed to be due to the short-radius fillet of the Wisconsin specimen, and to the short-radius fillet of the Upton-Lewis specimen together with acceleration effects in the vibrating parts of the Upton-Lewis machine.

Figs. 34 and 35 show the *S-N* curves obtained with the Olsen-Foster reversed torsion machine. The endurance limits taken from these curves are given in Table 5. The results thus far obtained indicate that the ratio of the endurance limit in torsion to the endurance limit of the same steel in bending varies from 0.48 to 0.57. An average of eight results shows that the endurance limit in torsion is about 0.52 of the endurance limit in bending.

The effect of changes in the details of the heat treatment of material on the endurance strength is well brought out by the two curves in Fig. 25 for the 0.37 carbon, sorbitic steel. The specimens for treatment A were turned to about 0.02 inch oversize and then heat treated. The specimens for treatment B were about $\frac{5}{8}$ inch testing. Table 3 shows that the tensile results for treatment B were square, and were first heat treated and then turned down to size for considerably lower than for treatment A, and Fig. 25 shows that the endurance limit was also lower. These results indicate the neces-

sity of having the conditions of heat treating as nearly the same as possible in order to get uniform results.

In those cases in which specimens from the same steel were tested in a normalized and in a sorbitic condition, the *S-N* curves show that the endurance limit is higher for the sorbitic condition by 31 per cent for the 0.52 carbon, 73 per cent for the 0.37 carbon, and 84 per cent for the 1.20 carbon steel. For the 0.93 carbon, the sorbitic gives an endurance limit 84 per cent higher than the pearlitic steel.

An interesting fact, shown by Table 3, is that the 0.37 carbon sorbitic steel has a percentage of elongation almost as high as the 0.37 carbon normalized steel, and the percentage of reduction of area is even higher. For the 0.93 carbon steel the ductility is almost exactly the same for the sorbitic specimens as for the pearlitic; for the 0.52 carbon steel the elongation is slightly less for the sorbitic specimens than for the normalized, but the reduction of area is greater; while for the 1.20 carbon steel the sorbitic condition has actually a higher ductility than the normalized. These results indicate that heat treatment may greatly improve the static and fatigue strength properties of the material with no serious sacrifice of ductility.

The tests were not conducted with the intention of comparing carbon steels with nickel and chrome-nickel steels, but certain qualitative results may be mentioned. Table 3 shows that the sorbitic treatment for the carbon steels, with the one exception of the 1.20 carbon steel, develops about the same ductility represented by percentage of elongation as the heat treatments which were used for the nickel and chrome-nickel steels. The results indicate that the nickel and chrome-nickel steels have the advantage of somewhat higher endurance limits for the same ductility. This result is not unexpected, judging from the well-known fact that these alloy steels in comparison with carbon steels show high ductility for a given static strength.

16. *Relation of Static Strength to Endurance Limit.*—The tests described in this bulletin seem to indicate that the results of static tests made in an ordinary testing machine are not reliable as an index of the strength of the material under reversed stress as de-

terminated by the rotating-beam test. In confirmation of this, attention is called to Fig. 37, in which are plotted values of the endurance limit, the proportional limit, and the ultimate tensile strength for

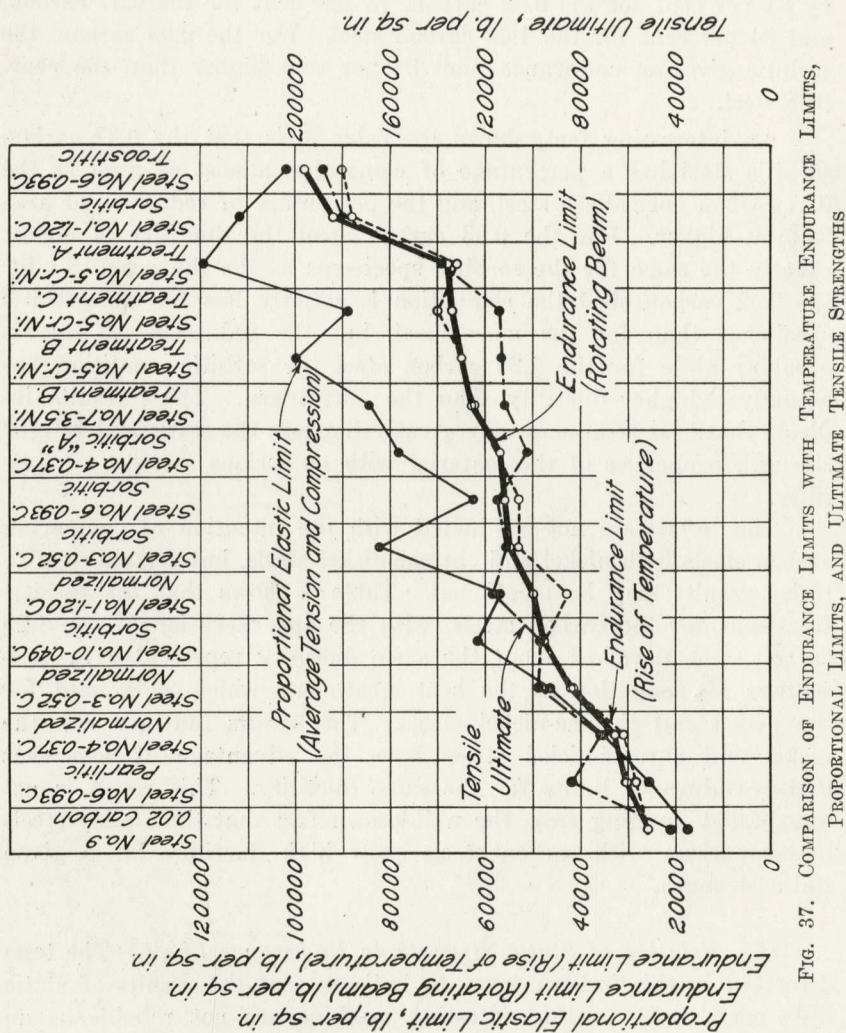

FIG. 37. COMPARISON OF ENDURANCE LIMITS WITH TEMPERATURE ENDURANCE LIMITS, PROPORTIONAL LIMITS, AND ULTIMATE TENSILE STRENGTHS

the various steels tested, arranged in such order that the endurance limits increase from left to right. The values for proportional limit do not follow at all closely the values for endurance limit. Computations from the values given in this figure show that the ratio of endurance limit to proportional limit varies from 1.5 to 0.5, making it apparent that the proportional limit cannot be used to predict fatigue strength in bending. The variation in the ratio of endurance limit to ultimate tensile strength is not as great as the variation just mentioned, but is considerable, the ratio ranging from 0.68 to 0.36. In general as the proportional limit and the ultimate tensile strength increase the endurance limit also increases.

Fig. 37 also shows values of the endurance limit as determined by a temperature test, which is discussed in detail in Chapter V.

A study of the endurance limits in torsion and the corresponding proportional limits shows that here also the proportional elastic limit is not a reliable index of fatigue strength. In this case, the ratio of endurance limit to the proportional elastic limit was found to range from a value of 1 for the 0.02 carbon steel and the 0.93 carbon pearlitic steel, to 0.51 for the chrome-nickel steel, treatment A.

The determination of the elastic limit and the ultimate strength (Fig. 37) depends upon the average properties of a considerable mass of material. A minute defect, such as a nick on the surface, an incipient crack in the structure, or a localized stress resulting from heat treatment, will not in general affect the determination to an appreciable extent. On the other hand, such a localized defect may readily act as a nucleus for structural damage which, under repeated stress, spreads in the form of minute cracks with continued localized stress present at the roots of these cracks, and finally causes failure.

It is readily conceivable that even for a material free from serious flaws non-homogeneity of structure might affect resistance to repeated stress to a much greater extent than it does static strength. Consider two materials, A, made up of strong and weak crystals with a large preponderance of strong crystals, and B, made up of crystals all alike, and all somewhat weaker than the strong crystals of A. It seems quite possible that material A will give higher elastic strength under static tests and lower strength under repeated stress than material B. Such might well be the case for the chrome-nickel

steel with heat treatment A as compared with the troostitic 0.93 carbon steel, the former corresponding to material A, and the latter to material B.

Fig. 25, which shows the $S-N$ curves for the three heat treatments of steel No. 5, chrome-nickel, is especially interesting. By referring to Table 3 it will be seen that treatment A gives the highest ultimate strength and proportional elastic limit; treatment B is about 15 per cent lower, yet the endurance limit is almost as high as with treatment A. Treatment C gives a low proportional elastic limit compared with the other two treatments, yet the endurance limit is actually a little higher than that for treatment B and almost as high as that for treatment A. This is particularly interesting in view of the fact that the proportional elastic limit of material with treatment C is low compared with its yield point, and that the tension stress-deformation curve shows considerable permanent set below the yield point. On the basis of mechanical hysteresis it would ordinarily be expected that a material which showed considerable permanent set would probably be poor in resisting fatigue. This does not seem to be the case for treatment C of the chrome-nickel as compared with the other two treatments.

One rather remarkable result is indicated by Fig. 37. Computation from values given in the figure shows that the ratio of the computed stresses at the endurance limit to the proportional elastic limit of the 0.02 carbon steel was almost 1.5, and the endurance limit was actually 33 per cent higher than the average yield point in tension and compression. This result may at first appear impossible, and it is believed that it would be impossible in reversals of direct tensile and direct compressive stress, but it must be recalled that the endurance limit here mentioned was obtained from a rotating-beam test. Evidently the inner fibers of the beam, which are not stressed as highly as those on the outside surface, reinforce the outer fibers sufficiently so that the nominal stress calculated is actually higher than the yield point of the material. Of course the outer fibers are actually stressed only to the yield point, but evidently enough of the inner fibres are sufficiently stressed so that the resisting moment of the beam is increased to about 33 per cent above that based upon the yield point. While the above is an explanation of the possibility of the result it does not make the result less remark-

able, especially in view of the fact that only one other steel, the 0.93 carbon, gave an endurance limit even approximately equal to the proportional elastic limit of the material, as is clearly shown in Fig. 37. This result is called remarkable not because of the high endurance limit developed (the endurance limit of the 0.02 carbon steel was the lowest of all the steels tested) but merely because of the high ratio of endurance limit to proportional elastic limit and to yield point, and because it is believed that so high a ratio has not been observed before.

It seems clear that, in any case, the endurance limit for steel can be no higher than its yield point. That is to say, the actual unit stress existing in fatigue is limited to the yield point, although the nominal calculated stress, as in the case of the 0.02 carbon steel, may sometimes be higher than the yield point.

This matter has been dwelt upon at length because it may offer a clue to a quality necessary in a steel to produce a high ratio of endurance limit to proportional elastic limit. Apparently the only quality possessed by the 0.02 carbon steel which offers an adequate explanation of the above phenomenon was its great homogeneity. This steel was almost pure ferrite, while all the other steels were made up of several constituents. The only other steel which showed an endurance limit higher than the proportional elastic limit was the 0.93 carbon pearlitic steel. When the steel is made up all of pearlite or all of ferrite the ratio of endurance limit to proportional elastic limit is high. It seems to the writers that perhaps one of the qualities to be desired in order to get a high ratio of endurance limit to proportional elastic limit may be homogeneity of structure.

From the test data given in Appendix A it appears that annealing various grades of steel gives a high ratio of endurance limit to proportional limit. It would seem reasonable that either homogeneity of metallographic structure or freedom from internal strains (such freedom as would be brought about by thorough annealing) should tend to give a high ratio of endurance limit to proportional limit.

It does not seem likely that ductility, as shown by percentage of reduction of area and by percentage of elongation, will have much bearing on the strength in fatigue. These quantities are based upon the action of a bar as a whole and in ductile materials are largely

dependent upon the final necking down after the ultimate has been reached. In fatigue failures there is no necking down, but the material fails as though it were brittle. Furthermore, the action in fatigue is extremely local and does not involve a large portion of the bar. A study of Table 3 will show the basis for the foregoing statements. The 0.93 carbon troostitic steel, for instance, shows low elongation and reduction of area, but a high endurance limit and a high ratio of endurance limit to proportional elastic limit.

It has been suggested by various investigators that the use of very delicate instruments for measuring deformation might enable an experimenter to detect in a static test the minute fractures which are supposed to occur at the endurance limit. An apparatus of great delicacy has been developed by Mr. W. J. Francke of New Brunswick, New Jersey,* who has tested in his laboratory specimens of several of the steels studied in this investigation. The results in Table 5 showing the "FR" point determined in the Francke test indicate that the stress corresponding to this "FR" point coincides quite closely with the endurance limit in some cases, but not so well in others. More information will be necessary to determine the value of the Francke test as a criterion of fatigue strength.

17. *Correlation of Results of Hardness Tests and of Impact Tests With Results of Reversed-Stress Tests.*—The results of the Charpy impact-bending tests, the Charpy impact-tension tests, and the repeated-impact tests indicate that the results of the impact tests made cannot be used as a criterion of fatigue strength. Fig. 38, in which the plan of plotting results is similar to that used in Fig. 37, makes this clear. The results of these impact tests bear no consistent relation to the endurance limits for the various steels.

Fig. 38 shows on the other hand a quite consistent relation between Brinell hardness and endurance limit. *Within the range of the materials tested in this investigation* it would seem, therefore, that the Brinell hardness test may prove to be valuable in predicting the approximate value of the endurance limit. This approximate value could then be checked by fatigue bending tests on a number of specimens not exceeding a value of 10 000 000 cycles of stress.

* Proc. Am. Soc. for Test. Materials, Vol. XX, Part II, p. 372, 1920.

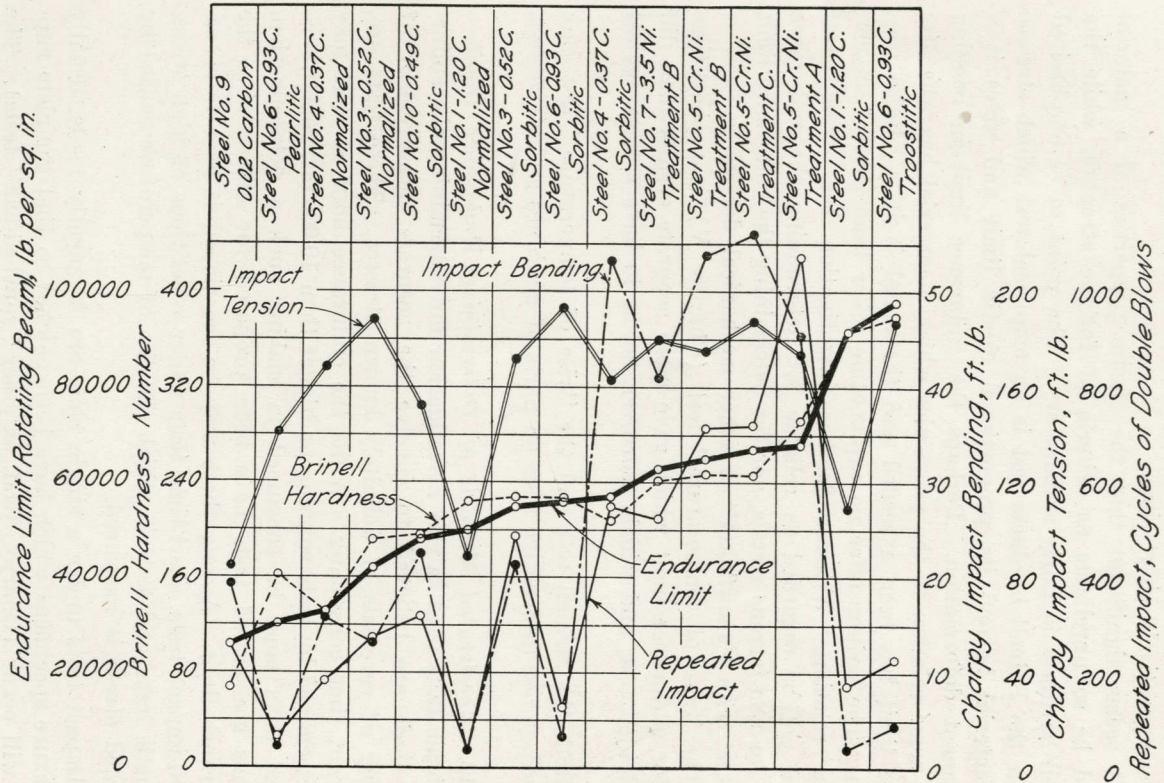

FIG. 38. COMPARISON OF ENDURANCE LIMITS WITH BRINELL HARDNESS, CHARPY IMPACT BENDING VALUES, CHARPY IMPACT-TENSION VALUES, AND REPEATED-IMPACT VALUES

By this procedure the endurance limit of a steel could be determined in a comparatively short time.

It seems significant that the elastic properties of a material should be so unreliable as criteria of fatigue strength, while the Brinell hardness is fairly satisfactory. The point to be emphasized is that the Brinell hardness test is an empirical test which stresses the material beyond its proportional elastic limit and gives it a permanent deformation. Perhaps the endurance limit in bending bears some relation to the properties which a material has when its elastic limit has been exceeded and the metal is in a plastic condition. The writers offer no explanation other than that of an empirical relation. Without further investigation the Brinell test should not be regarded as reliable for determining the endurance limit for non-ferrous metals, nor for determining the endurance limit for steel with "snowflakes" or other mechanical defects.

The "rise of temperature" test (Chapter V) is a short-time test for endurance limit which gave more accurate results than did the Brinell test, and which, moreover, seems to have a more logical basis.

Both the Brinell test and the "rise of temperature" test may be used as non-destructive tests on parts of machines and structures.

18. *Accelerated Methods of Determining Endurance Limit.*—

The basic tests used in this investigation for determining the endurance limit are believed to involve the accurate measurement of number of reversals of definitely known stresses. These tests are, however, time consuming. While the endurance limit of steel may be determined by tests running no higher than 10 000 000 repetitions, several days must be consumed in making such a determination. Various accelerated tests have been proposed for determining the endurance limit. Among these may be mentioned impact tests, repeated-impact tests, short-time tests under repetitions of high stress, magnetic tests, and tests in which the rise of temperature caused by repeated stress is measured.

Impact tests under a single blow are frequently made, usually on flexure specimens which have been notched so that complete rupture will occur (Charpy, Izod, or other "notched-bar" tests). The action of a single impact is widely different from that of repeated

stress; both impact tests and repeated stress tests do, however, emphasize the influence of local defects. No correlation could be observed between the results of reversed-stress tests in this investigation and the results of single-blow impact tests.

Repeated-impact tests are sometimes made upon flexure specimens notched to localize failure, using a few hundred light blows in place of one heavy blow. In this class are tests on a "Stanton" machine or one similar in principle. These tests would seem to be a somewhat arbitrary compromise between a single-blow impact test and a repeated-stress test, and it is not possible to measure the stress set up in the notched bars used. The repeated-impact tests made in this investigation used a rather heavy blow for the size of specimen. The results of these repeated-impact tests failed to show any correlation with the results of the reversed-stress tests.

Short-time repeated-stress tests under high stresses have frequently been made and have given values for comparison, either on the basis of a constant stress and relative endurance of two steels, or on the basis of relative magnitude of stress corresponding to a given endurance. The results of the present investigation, and of some other investigations, seem to indicate that short-time, high-stress tests do not always give results corresponding to long-time, low-stress tests. This is illustrated by a comparison of the $S-N$ diagrams for cold-drawn steel (Fig. 27) with the $S-N$ diagram for 1.20 carbon steel normalized (Fig. 24). Comparing the values of N for a value of S of 60 000 pounds per square inch, the cold-drawn steel would seem the more resistant to repeated stress; comparing the values of N for a value of S of 45 000 pounds per square inch, the cold-drawn steel fails after about 1 000 000 cycles of stress while the 1.20 carbon normalized withstands 100 000 000 cycles without failure. Further discussion of such tests is given in Appendix A.

Magnetic tests to detect microscopic incipient fractures developed under repeated stress hold some promise of success, but are applicable only to ferrous metals. This test has not been thoroughly developed so far as the writers are aware, but promising preliminary results have been obtained by Dr. C. W. Burrows of New York, and by Mr. R. L. Sanford of the United States Bureau of Standards.

A study of the rise of temperature produced after a few hundred repetitions of stress has been proposed by various investigators,

and especially by Mr. C. E. Stromeyer of Manchester, England, who made a preliminary experimental investigation of this test. This test has been given special study in the present investigation and the results of that study are given in detail in Chapter V by Messrs. Putnam and Harsch.

19. *Effect of Cold Work on Fatigue Strength.*—The upper half of Fig. 27 shows the *S-N* curves for Steel No. 51, which was received in the form of hot-rolled, half-inch, reinforcing bars. Part of this material was tested as received, part was stretched in tension until the diameter had been reduced to 0.48 inch, part had the diameter reduced in the same way to 0.44, and part was bent cold through 45 degrees and straightened. The cold stretching was such that the material reduced to 0.48 inch was stressed to a point between the yield point and ultimate. The material reduced to 0.44 inch was stressed up to the ultimate and was about to neck down. In each case after the material had been cold worked it was raised to a temperature of 500 degrees F. and held there for 15 minutes, so that it might recover its elasticity rapidly. The tension test results, which were determined from specimens $\frac{1}{4}$ inch in diameter taken from the ends of the rotating-beam specimen, are shown in Table 3. The specimens for the rotating-beam machine were prepared in the standard manner.

Fig. 27 shows that the cold bending raised the endurance limit slightly, about 7 per cent. The cold stretching raised the endurance limit in the first case about 25 per cent, and in the second case about 46 per cent. The cold stretching in the above two cases raised the proportional elastic limit about 57 and 82 per cent, respectively; and the ultimate about 10 and 19 per cent, respectively. The endurance limit is therefore influenced to a much smaller degree by cold stretching than is the proportional elastic limit.

The lower half of Fig. 27 shows the *S-N* curves for Steel No. 50, received in the form of $\frac{7}{16}$ round bars. Some of this material was tested as received, some after annealing at 1300 degrees F., and some after annealing at 1550 degrees F. Taking the material annealed at 1550 degrees F. as a standard, the endurance limit for the 1300 degrees F. annealing is 16 per cent higher, although this value is somewhat in doubt, and that of the material as received is 64 per cent higher.

The tension test values in Table 3 show that the results after annealing at 1300 degrees F. are about the same as after annealing at 1550 degrees F.; but the results for the material as received are higher than those for the material annealed at 1550 degrees F. by 97 per cent and 49 per cent for the proportional elastic limit and ultimate strength, respectively. These last results again show that the endurance limit is not affected by cold work to the same degree as is the proportional elastic limit.

The results on Steel No. 50 bear out the results found by previous investigators. There is practical unanimity in the statement that annealing reduces the fatigue strength.

The results on Steel No. 51 contradict the results previously found by Moore and Putnam.* Although they did not continue the tests to a sufficiently high number of cycles of stress to determine the endurance limit, yet their curves show clearly that cold stretching reduces the strength in fatigue.

There is a possible explanation for the contradiction. Moore and Putnam used flat fatigue specimens prepared for the Upton-Lewis reversed-bending machine. The specimens were cold stretched and then tested without having the surface finished in any way. In the present tests the material was cold stretched, then the rotating-beam specimens had their diameter reduced by the standard radius of 9.85 inches from 0.48 and 0.44 inch to 0.30 inch, and the surface was given the standard polish. It is believed that the removal of the outside material and the polishing of the surface account for the difference. It is well known that a specimen stretched beyond its yield point has its surface roughened, and it is highly probable that this surface is a source of weakness in fatigue in that it is probably covered with minute cracks which are nuclei for the spreading of structural damage.

20. *Effect of Shape of Specimen on Endurance.*—One of the factors known to influence the endurance of a metal under repeated stress is a sudden change in cross-section. Stanton and Bairstow† have shown that specimens with Whitworth screw threads, and also those with square shoulders plus a small fillet, suffer a reduction in

*Am. Inst. of Mining Engrs., 1919, p. 401.

†Inst. of Civil Engrs. (British), Vol. CLXVI, IV, p. 78, 1905-6.

endurance strength of about 30 per cent for hard steel, for soft steel, and for wrought iron, while specimens with square shoulders suffer a reduction of about 50 per cent for hard steels and from 35 to 45 per cent for mild steels and for wrought iron. Eden, Rose, and Cunningham* found that a sharp V-notch reduced the endurance strength of bright drawn mild steel about 25 per cent. Square shoulders reduced the strength of both hard and soft steels by 40 per cent, while keyways at flange couplings reduced the strength of steel by 50 per cent, and the strength of wrought iron by 23 per cent. Wöhler† found in some tests on axle steel stressed from zero to a maximum in repeated tension that specimens with square shoulders as compared with specimens having well-rounded shoulders had their strength reduced about 37 per cent. On rotating-beam specimens of wrought iron the reduction of strength due to square shoulders ranged from 11 to 22 per cent.

In the present investigation some tests were run on the effect of shape of specimen on fatigue strength, especially on the effect of radius of fillet. Steel No. 10 (0.49 carbon) in the sorbitic condition was used in making the first series of these special tests. The shapes of the specimens are shown in Fig. 39, the cross-section being reduced by a 9.85-inch radius, by a 1-inch radius, by a $\frac{1}{4}$ -inch radius, by square shoulders, and by a 90 deg. V-notch, respectively. In each case enough specimens were tested to determine the endurance limit quite definitely.

Fig. 28 shows the *S-N* curves for these tests. Fig. 26 should also be consulted because it gives the *S-N* curve for the 0.49 carbon steel when finished with a standard radius of 9.85 inches. It should be explained that the material used for these tests was heat treated in two batches, and it was observed that the specimens from the first batch gave an endurance limit of about 50 500 pounds per square inch (for specimens with standard surface finish); while specimens from the second batch gave an endurance limit of about 48 000 pounds per square inch. The specimens with $\frac{1}{4}$ -inch radius and most of the specimens with square shoulders were from the first batch, while the specimens with 1-inch radius and those with the V-notch were from the second batch. The results shown for the standard specimen

* Inst. of Mech. Engrs. (British), 1911, III-IV, p. 839.

† Engineering (London), Vol. XI, 1871.

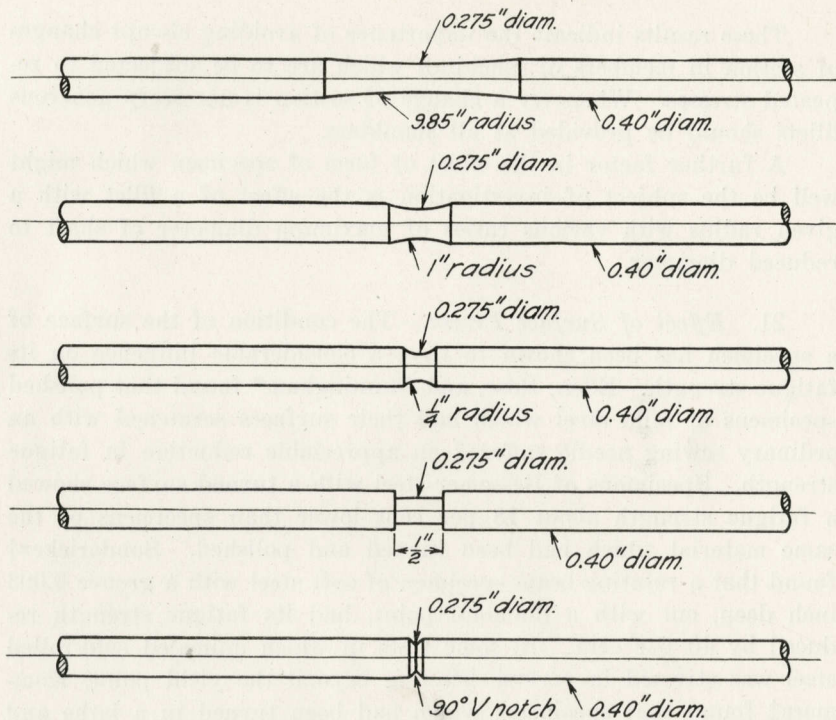

FIG. 39. SPECIMENS FOR STUDY OF EFFECT OF SHAPE ON ENDURANCE LIMIT

in Fig. 26 are from both batches. Specimens with a 1-inch radius are evidently almost as good in resisting fatigue as those with a 9.85-inch radius. The $\frac{1}{4}$ -inch radius shows a reduction in endurance limit as compared with the 9.85-inch radius of about 8 per cent; the square shoulders show a reduction in fatigue strength of about 51 per cent; and the V-notch a reduction of about 60 per cent.

Fig. 28 shows some effects of shape of specimen using Steel No. 9, 0.02 carbon, a very ductile steel. Fig. 26 shows the results for this steel with the standard specimen. For the specimens with $\frac{1}{4}$ -inch radius the endurance limit is reduced about 15 per cent, and for specimens with square shoulders, about 48 per cent.

The results on specimens of 0.02 carbon steel together with the results on specimens of 0.49 carbon steel indicate that the percentage of reduction of endurance limit due to the effect of abrupt change of section is about the same for the two steels.

These results indicate the importance of avoiding abrupt changes of section in members of machines which are to be subjected to repeated stresses. Whenever a change of section is necessary generous fillets should be provided at all shoulders.

A further factor in the effect of form of specimen which might well be the subject of investigation is the effect of a fillet with a given radius with various ratios of maximum diameter of shaft to reduced diameter.

21. *Effect of Surface Finish.*—The condition of the surface of a specimen has been shown to have a considerable influence on its fatigue strength. Eden, Rose, and Cunningham* found that polished specimens of mild steel which had their surfaces scratched with an ordinary sewing needle suffered an appreciable reduction in fatigue strength. Specimens of Bessemer steel with a turned surface showed a fatigue strength about 18 per cent lower than specimens of the same material which had been turned and polished. Sondericker† found that a rotating-beam specimen of soft steel with a groove 0.003 inch deep, cut with a diamond point, had its fatigue strength reduced by 40 per cent. In some tests in which annealed cold-rolled steel was stressed in reverse bending beyond the yield point, Komers‡ found that specimens which had been turned in a lathe and specimens which had been turned and then filed had their endurance reduced 30 and 18 per cent respectively, as compared with specimens which had been turned, filed, and polished. In the last named tests endurance was measured by the number of cycles of stress before rupture.

In order to study the effect of surface finish on the endurance strength of steel, five different series of specimens were prepared. Steel No. 10, 0.49 carbon sorbitic, was used for the first series.

The five degrees of finish were: first, the standard finish, made with No. 0 and No. 00 emery cloth; second, a high polish in which, after using No. 0 and No. 00 emery cloth, the specimens were polished with emery papers Nos. 1, 0, and 000, and finally with rouge and broadcloth, a microscope with a magnification of 100 diameters being

* Inst. of Mech. Engrs. (British), 1911, III-IV, p. 839.

† Tech. Quart. (Boston), March, 1899.

‡ Proc. Int. Assn. for Test. Materials, 1912, Art. V4a.



(a) Rough Turned Finish

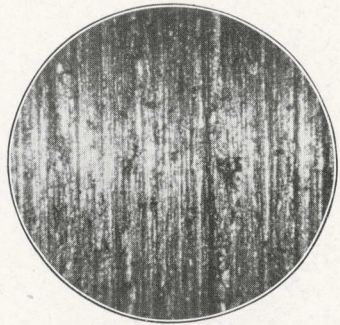

(b) Smooth Turned Finish

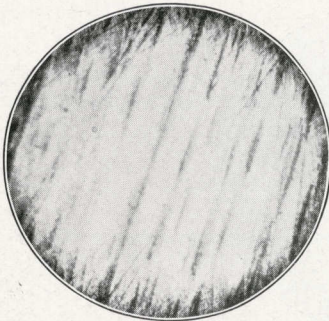

(c) Ground Finish



(d) Standard Finish

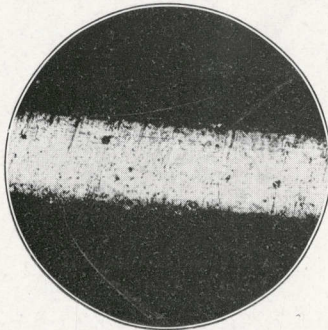

(e) Rouge Finish

FIG. 40. MICROGRAPHS OF SURFACE FINISH
Magnification 30 diameters



FIG. 41. MICROGRAPH OF SURFACE OF ROUGE-FINISHED SPECIMEN
Magnification 100 diameters

used to make sure that all scratches were removed; third, a ground finish obtained with a grinding wheel; fourth, a smooth-turned finish with a lathe tool; and fifth, a rough-turned finish with a lathe tool. Fig. 40 shows the photographs, under a magnification of 30 diameters, of the five degrees of finish. Fig. 41 shows the rouge finish under a magnification of 100 diameters, and indicates the degree to which the very fine scratches were removed.

Fig. 29 shows the *S-N* diagrams obtained with four of these series. Fig. 26 should be consulted also, since it shows the results obtained with the standard finish. As was the case with the tests discussed in Section 20, the material for the first series was taken from two batches of steel, heat treated at two different times. The first batch showed an endurance limit of about 50 500 pounds per square inch and the second batch an endurance limit of about 48 000 pounds per square inch. The rouge-finish specimens were taken from the first batch, the rough-turned were taken from the second batch, while the ground and the smooth-turned were taken from both batches, as were the specimens with standard finish.

The *S-N* curves make it clear that the rouge finish is probably slightly better than the standard finish in withstanding fatigue. The ground-finish endurance limit is slightly lower than the standard-finish, and the smooth-turned and rough-turned fall below the ground-finish in the order named. The rough-turned finish, the weakest, has an endurance limit about 18 per cent lower than the rouge finish.

There is so little difference between the rouge finish and the standard finish, especially in view of the fact that a number of the standard-finish specimens of the first batch ran out to 10 000 000 cycles of stress without failure at a unit stress of slightly over 50 000 pounds per square inch, that it is felt that the use of the standard finish is fully justified. The rouge finish was of course very expensive and time consuming, and is difficult to maintain free from corrosion; therefore it is not considered practical.

Fig. 29 shows some results of the effect of surface finish on specimens of Steel No. 9, 0.02 carbon, a very soft steel. The endurance limit for the rough-turned specimens seems to be slightly less than for the smooth-turned. The reduction in endurance limit of the turned specimens as compared with specimens with standard finish (see Fig. 26) ranges from 8 to 12 per cent.

Comparing the results of tests on specimens of 0.02 carbon steel with specimens of 0.49 carbon steel, sorbitic, it is seen that the percentage reduction in endurance limit due to smooth turning and to rough turning, as compared with the standard finish, is about the same for the two steels.

The results of this study make it clear that the finish of a machine member subjected to fatigue may have an appreciable effect on its endurance strength. It also appears that fine grinding would probably be satisfactory as a commercial finish.

22. *Effect of Overstress.*—From the standpoint of Bauschinger's theory regarding failure due to fatigue, and also from the fact that in practice many machine members subjected to fatigue are occasionally overstressed, it seemed desirable to determine whether stressing a material above its endurance limit for a certain number of cycles and subsequently testing it in fatigue in the usual manner would result in any change in the endurance limit.

The material used in this study for the first series of tests was Steel No. 10, 0.49 carbon, sorbitic.

Six different combinations of overstress and number of cycles were used. The endurance limit of the material having been determined in the standard manner (See Fig. 26), about 12 specimens were subjected to 5000 cycles of stress, the unit stress used being 10 per cent higher than the endurance limit previously determined. After this treatment the specimens were tested in the usual manner with varying stresses to determine whether the endurance limit would now be different. In the same manner other series of specimens were tested with 20, 29, 29, 35, and 38 per cent of overstress, the number of cycles of applied overstress being 5000, 5000, 1000, 1000, and 100 respectively.

The material for these tests, just as was the case in the previous section, was taken from two batches of steel heat treated at two different times. The first batch showed an endurance limit of about 50 000 pounds per square inch and the second batch one of about 48 000 pounds per square inch. The specimens subjected to 10, 20, and 38 per cent overstress were taken from the first batch of steel, and the calculation in per cent of their endurance limits is based upon an endurance limit of 50 500 pounds per square inch. Those

subjected to 29 and 35 per cent overstress were taken from the second batch, and the percentage calculation is based on 48 000 pounds per square inch. The specimens with 10, 20, and 29 per cent overstress were subjected to 5000 cycles of overstress at 1500 revolutions per minute, the specimens with 35 per cent overstress, and one set of the 29 per cent overstress specimens to 1000 cycles at 1500 revolutions per minute, and the specimens with 38 per cent overstress to 100 cycles applied slowly by hand.

Fig. 30 shows the *S-N* curves obtained from these experiments. Fig. 26 should also be consulted since it shows the curve obtained for this material when there was no overstress. It is evident from the curves that 10 per cent and 20 per cent overstress applied 5000 times, 29 per cent overstress applied 1000 times, and 38 per cent overstress applied 100 times do not appreciably reduce the endurance limit. On the other hand, 35 per cent overstress applied 1000 times reduces the endurance limit about 4 per cent, while 29 per cent overstress applied 5000 times reduces the endurance limit about 11 per cent.

These last two results illustrate clearly the effect that the number of cycles of applied overstress has on the percentage reduction of endurance limit. Such a result is of course to be expected, because it is evident that if the higher stress were continued it would make the specimen fail at a stress on the sloping part of the diagram in Fig. 26. Since, however, this higher stress is not continued up to complete failure, it seems obvious that a smaller stress would take fewer cycles to cause failure than would normally be the case had there been no overstress. A few calculations indicate that the amount which the endurance limit is reduced in any case depends upon the ratio of the number of cycles of overstress to the total number of cycles of this stress which would cause failure.

The results for the specimens with 20 and 38 per cent overstress indicate that a machine member can withstand a considerable percentage of overstress without damage if that overstress is applied only a comparatively small number of times, and if the overload is not severe enough to make actual dents or nicks in the surface at points of localized pressure.

Fig. 31 shows some effects of overstress on specimens of steel No. 1, 1.20 carbon, sorbitic, subjected to a stress 20 per cent above

the normal endurance limit; in one case 5000 cycles of overstress were applied, and in the other case 10 000 cycles. The endurance limit seems to be slightly lower for the specimens subjected to 10 000 cycles of overstress than for the specimens subjected to 5000 cycles, and the reduction of endurance limit of the overstressed specimens as compared with material not subjected to overstress ranges from 12 to 14 per cent. Fig. 24, which gives the results for this material not subjected to overstress, should be consulted for comparison.

Comparing the results for 5000 cycles with 20 per cent overstress for the 0.49 carbon steel, sorbitic, and the 1.20 carbon steel, sorbitic, it is evident that the effect of overstress in reducing the endurance limit is more serious for the 1.20 carbon steel than for the 0.49 carbon steel.

The three studies of shape, surface finish, and overstress give a good idea of the relative seriousness of their effects in reducing the endurance limit. The maximum reduction noted in the overstress experiments was 14 per cent, that in the surface finish experiments was 18 per cent, while that in the experiments on shape was 60 per cent. While both overstress applied for a short time and poor surface finish reduce the endurance limit, the most serious reduction results from sudden changes in cross-section, especially in the case of machine members having square shoulders and sharp notches anywhere in their length.

Overloading a machine part may be accompanied by the formation of grooves and deep scratches due to wear, and these grooves and scratches may have a greater influence in reducing strength under repeated stress than the direct effect of the nominal overstress accompanying the overload.

23. *Theories of Nature of Fatigue of Metals.*—One theory of the nature of the fatigue of metals is the "crystallization" theory which had its origin in a study of the fractured surfaces of machine parts that had failed under repeated stress. These surfaces, even for soft material like wrought iron, appeared jagged and crystalline. This theory implied that under the action of repeated stress the internal structure of a metal changed from fibrous to crystalline, and that different metals varied in their resistance to this change.

By the use of the microscope all metals are seen to be of a crystalline structure under all service conditions, and no evidence of appreciable change of structure can be observed in a metal subjected to repeated stress. There does appear to be a breaking down of crystals as indicated by the formation of minute cracks or "slip bands" extending across the crystal. The crystallization theory has been practically abandoned.

A second theory was that advanced by the distinguished German investigator, Bauschinger,* that, under stress varying from zero to a maximum, it is possible for metals to acquire new elastic limits which for this range of stress may lie anywhere between the original proportional elastic limit and the yield point, and may in some cases even exceed the yield point. These new elastic limits, or "natural" elastic limits, as he called them, depend upon the number of cycles of stress to which the material is subjected, being higher for the greater number of cycles. For stresses within this natural elastic limit the metal is assumed to possess indefinite endurance, and he found experimentally that specimens under stresses varying from zero to a maximum would withstand several million repetitions of stress without failure. He did not, however, make any long-time tests under reversed stress. Bauschinger's theory does not imply a change of the crystalline structure but does imply some change in the inherent nature of the material.

The writers have seen very few published experimental results in which it was attempted to apply Bauschinger's theory to reversed stresses. Stanton and Bairstow† mention three specimens which had withstood 1 000 000 cycles of stress without failure and which were subsequently tested to determine their elastic limits. These specimens had been subjected to direct stress in which the ratio of tension to compression was 1.4 to 1. The results showed that in each case the new elastic limit was practically equal to the highest tension and compression which had previously been applied, although these new limits were very much lower than the original or "primitive" elastic limits.

* "Mitteilungen des Mechanisch-technischen Laboratoriums" der kgl. Techn. Hochschule, München, heft 13;

Dingler's Journal, Bd. 224;

Unwin, "The Testing of the Materials of Construction." 1910 edition, Chap. XVI.

† Inst. of Civil Engrs. (British), Vol. CLXVI, IV, p. 78, 1905-6.

Poppewell* determined the natural elastic limits by only 10 cycles of reversed direct stress and then attempted to check these values by rotating-beam tests. His natural elastic limits were lower than the primitive elastic limits, and the endurance limits from the rotating-beam tests were about equal to the primitive elastic limits. It seems to the writers that the check tests should have been made with a direct-stress machine instead of a rotating-beam, and it also seems questionable whether 10 cycles of stress would be enough to develop Bauschinger's natural elastic limits.

A series of tests to throw light on this matter is discussed in Section 36, "Effect of Repeated Understressing."

A third theory has been suggested by various investigators, and was developed by the writers, who afterwards found that it had been previously elaborated by Gilchrist.† This theory, while not directly contradictory to that of Bauschinger, presents a different picture of the mechanism of fatigue failure.

In discussing Wöhler's results Gilchrist has stated this theory as follows:

"(1) The average stress in the bars broken in Wöhler's machines did not reach the statical breaking load.

"(2) The fracture was caused by the statical breaking limit being exceeded at one point only, from which, when once started, rupture spread, at first rapidly, then more slowly, sometimes continuing to complete separation of the two parts of the bar, but occasionally stopping short of complete rupture.

"(3) The raising of the stress at the point where fracture commenced was due to an irregularity in the bar. This might be an irregularity or discontinuity in the metal, either on the surface or in the body of the bar.‡

"(4) A bar of uniform strength whose surface was perfectly smooth, with no sharp corners in the longitudinal configuration and the structure of which was perfectly homogeneous would endure, without breaking, an indefinite number of repetitions of a stress varying between zero and a value near to the breaking strength.

*Inst. of Civil Engrs. (British), Vol. CXCVII, III, p. 264, 1913-14.

†The Engineer (London), Vol. 90, p. 203.

‡The frequent occurrence of high localized stress which is usually overlooked in using the ordinary methods of computation is strikingly demonstrated by the mathematical work of Inglis and others, and by the experimental work of Coker and Preuss. See:

Trans. Inst. of Naval Architects (British), Vol. LV, Part I, p. 219, 1913;

Engineering, London, April 21, 1911, and March 8, 1912;

Zeit. des Ver. Deut. Ing., 1913, Part 1, p. 664;

"Johnson's Materials of Construction." Fifth Edition, p. 663.

“(5) A bar similar to that under (4) could, under certain conditions, endure an indefinite number of repetitions of a load varying between tension and compression of equal values both beyond the ordinary primitive elastic limits.”

The writers agree in general with the foregoing statements, but, on account of the fact that a perfectly homogeneous material is not likely to be found for engineering purposes, they believe that the limitations of statement (4) as applied to ordinary metals should be set forth for the sake of clearness. It appears to them that the practical limit even for the case of stress varying from zero to a maximum will be the yield point of the material.

This theory may be called the theory of non-homogeneity or of localized stress. The effect of external non-homogeneity due to scratches, tool marks, square shoulders, and notches is well known and is discussed in another section of this bulletin. Internal non-homogeneity may be due to blow-holes, pipes, inclusion of slag, irregularity of crystalline structure on account of the presence of two or more constituents of varying strength, variation in orientation of crystals, or the presence of initial stresses caused by mechanical working or heat treatment. Owing to the minute area over which it exists, this localized stress produces no appreciable effect under a single load, but under load repeated many times there is started from this area a microscopic crack, at the root of which there exists high localized stress which under repetition of stress spreads until it finally causes failure.

The writers do not look upon these fatigue failures as being due necessarily to accidental flaws or irregularities. Such failures may, in practice, often be due to such causes, but the definiteness of the endurance limits found in the present tests points to the conclusion that the endurance limit is a property of the material just as much as the ultimate strength. If in these tests the failure is due to flaws, then it is believed that these flaws are an inherent part of the structure of the particular steel which is being tested.

As evidence supporting this theory the following facts are given:

(1) In the case of material of homogeneous structure, such as a specimen of 0.02 carbon steel, which is almost pure ferrite, or a specimen of 0.93 carbon steel, which is almost pure pearlite, it is found possible to develop an endurance strength nearly or quite

equal to the primitive elastic limit. This is a direct verification of (5) in Gilchrist's theory.

(2) In the case of steels composed of a mixture of ferrite and pearlite the endurance limit is found below the primitive elastic limit, indicating to the writers' minds a progressive failure, first of the weaker constituent, then of the stronger.*

(3) Mathematical analysis, special measurement of stress distribution, and repeated-stress tests of specimens with notches and specimens with rough surface finish all indicate how important mechanical imperfections in surface may be in increasing localized stress and hence in reducing fatigue strength. There would seem to be no reason for doubting that internal non-homogeneity produces a similar effect.

The actual mechanism of fatigue failure has not been studied for a great variety of steel structures. It is known that in the softer steels the failure seems to be due to the production of slip bands (see Appendix B) which finally develop into cracks. For a very homogeneous material like 0.02 carbon steel it seems probable that a certain unit stress will be sufficient to cause slipping in the gliding planes of the crystals. Thereafter, the adjacent material will begin to slip under succeeding repetitions of stress until all the other material has yielded the same amount. This action will continue until the first material has reached the ultimate strength and actually opened up a crack. From then on the action will be rapid and failure will occur soon.

Just what happens in a material like the chrome-nickel, treatment A, in which the endurance limit is very much below the proportional elastic limit is not altogether clear. It is likely that non-homogeneity and especially the presence of internal stresses play an important part.

*It should be borne in mind that localized weakness may be caused by strains due to heat treatment as well as by non-uniformity of metallographic structure. Tests reported verbally by D. J. McAdam, of the U. S. Naval Academy Eng. Exp. Sta., indicate that thorough annealing as well as homogeneity of structure seems to be effective in giving a high ratio of endurance limit to proportional elastic limit. This is further confirmed by test results on annealed steel of various carbon contents as shown by Fig. 44 and Table 10.

V. "RISE OF TEMPERATURE" METHOD OF DETERMINING ENDURANCE LIMIT

By W. J. PUTNAM and J. W. HARSCH*

24. *Thermal Phenomena in Metals Under Stress.*—The determination of endurance limit by the actual application of repeated stress, by a test on a rotating-beam testing machine, for example, requires so much time that it is not a practical commercial test and various other methods have been tried, such as the examination of the hysteresis loop, magnetic exploration, and calorimetric determination.

The fact was first mentioned by Lord Kelvin† in 1855 that a material subjected to stress within its ordinary static elastic limit is subject to a change of temperature, cooling if in tension, and heating if in compression. Since that time Turner,‡ Rasch§, and Capp and Lawson¶ have made use of this thermal change as a method of determining the elastic limit in tension, defining it as the least stress at which the temperature of the specimen begins to rise.

In 1913 C. E. Stromeyer** tried the method of determining the fatigue limit under alternating stress conditions by means of the heat generated due to inelastic action. He located the endurance limit at that minimum alternating stress which after a few hundred rapid repetitions will just generate heat in the test pieces. His determinations of heat were made by sensitive mercury thermometers immersed in a steady stream of water just before and just after it had flowed

*Professor W. J. Putnam of the Department of Theoretical and Applied Mechanics of the University of Illinois, and J. W. Harsch, Metallurgist with the Investigation of the Fatigue of Metals. Professor Putnam was responsible for the preliminary development of the apparatus and methods of testing, and Mr. Harsch developed the present form of apparatus used, and carried out the "rise of temperature" tests made in connection with this investigation.

†Quart. Math. Journal, 1855.

‡Trans. Am. Soc. of Civil Engrs., Jan., 1902.

§Proc. Int. Assn. for Test. Materials, Art. VII, 1909.

¶Proc. Int. Assn. for Test. Materials, Art. IX8, 1912.

**Memorandum of the Chief Engineer of the Manchester (England) Steam Users Association, 1913. See also Engineering, London, June 19, 1914.

over the test piece, and he disregarded differences of temperature of less than 0.02 degree C. This method involves the determination of the quantity of heat generated, and the difference in temperature of the entering and leaving stream depends on the rate of flow. The work of Stromeyer was, however, incomplete, inasmuch as the actual fatigue tests carried out to check the calorimetrically determined endurance limits were for the most part carried to less than one million repetitions of stress.*

25. *Apparatus.*—The “rise of temperature” machine, Figs. 42(a) and 42(b), used in the present series of tests was designed to test the regular 13-inch, rotating-beam specimen, Fig. 18, and to produce the same type of stress as that produced in the rotating-beam machine used for the main series of tests described in this bulletin. As shown in Fig. 42(a), the specimen *S* is held horizontally in V-notch grips, *A*. The load is applied on a ball bearing, *B*, at the end of the specimen, the bearing being heat-insulated from the specimen by a fiber collar 1/16 inch thick. The machine is also heat-insulated from the base at points *E* and *F* to prevent heat traveling from the bearings through the base to the specimen. The load on the specimen is measured by reading the deflection of the Ames dial, *C*, a load-deflection curve for the specimen having been previously obtained by recording a set of loads and corresponding deflection readings. The load can be varied by an adjusting screw, *D*, in the head of the machine. A thermo-couple cannot be readily attached to a rotating specimen, and it will be noted that the machine is so designed that the specimen does not turn, but that the head of the machine rotates. The left-hand end of the specimen is thus moved in a circle concentric with its axis, the radius of the circle being that deflection corresponding to the desired stress.

After considering various methods of temperature measurement it was decided to measure the temperature change of the test piece itself, and it was first attempted to measure change of temperature by measuring the change in resistance of small coils of copper wire

* Since the preparation of the manuscript for this bulletin there has been reported a series of tests in the British National Physical Laboratory in which the “rise of temperature” test is shown to give a fairly accurate measure of the endurance limit. A special short-time deflection test is also recommended for determining the endurance limit. The tests were made by H. J. Gough and were reported in “The Engineer” (London), Aug. 12, 1921, and an abstract appears in “Mechanical Engineering” for October, 1921.

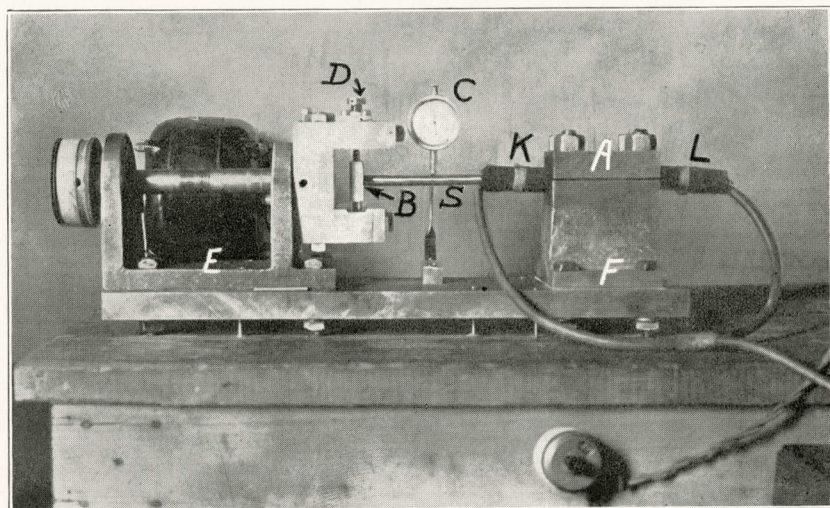

(a)

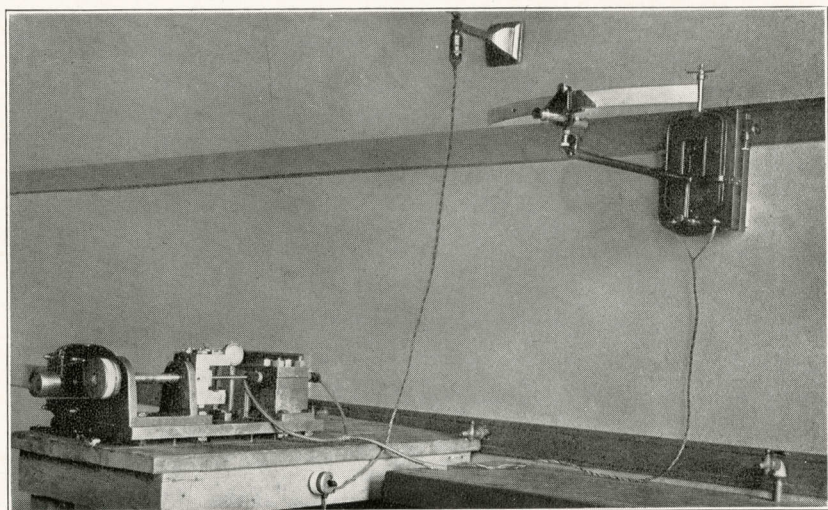

(b)

FIG. 42. MACHINE FOR "RISE OF TEMPERATURE" TESTS

held directly against the specimen. One coil was attached at the section of greatest stress and the other to the unstressed portion of the specimen just beyond the holding clamp, thus neutralizing the effect of any change in temperature of the machine. The coils having been balanced on a Wheatstone slide-wire bridge, any change in temperature would unbalance the system by an amount which, as indicated by the galvanometer, would denote the amount of change in temperature. The unbalancing, however, changed the amount of current flowing through each coil and therefore caused an added change in temperature of the coils. Then, too, the coils were so delicate that the repeated handling and the slight friction to which they were subjected soon destroyed the insulation on the wires.

Differential copper-constantan thermo-couples made from No. 30 *B* and *S* gage wire were then used. These were attached in locations corresponding to those used for the resistance coils, the one, *K*, at the section of greatest stress being tightly taped against the steel, and the other, *L*, separated from the steel by a single layer of thin paper. This arrangement proved very satisfactory and calibration showed it to be sensitive to 0.003 degree C. The couples were connected in series with a Leeds and Northrup, Type H, D'Arsonval galvanometer, shown in Fig. 42(b). When the couples were at the same temperature no deflection was shown, but when either varied in temperature from the other a corresponding deflection occurred.

26. *Materials.*—By the rise of temperature method several steels in the general series were tested, thus checking the reliability of this method since the endurance limit of each steel was definitely known from long-time tests, and the series covered a wide range. Duplicate and triplicate tests were made on several of the steels to ascertain the reliability with which the endurance limit could be determined, and the results thus obtained were well within the limits of the precision of stress adjustment.

27. *Tests.*—The test finally adopted as a standard consists in running the machine for 30 seconds at a speed of 1000 revolutions per minute at a known stress and recording the maximum deflection of the galvanometer. Then, with a series of such readings cor-

responding to a series of stresses, a curve is plotted to show the increase in temperature with increase of stress. The point at which the curve shows a sharp break corresponds to the endurance limit. Typical curves are shown in Fig. 43. In the cases of carbon steels with sorbitic structures and in the case of alloy steels it was found necessary to increase the time of the run, at each stress, from 30 seconds to 2 minutes, since these materials are slower in heating under stress.

28. *Results and Discussion.*—Endurance limits determined by the rise of temperature tests are shown in Table 8. Besides the

TABLE 8
COMPARISON OF ENDURANCE LIMIT FOUND BY ROTATING-BEAM TESTS WITH
THAT FOUND BY "RISE OF TEMPERATURE" TESTS

No.	STEEL	Endurance Limit, lb. per sq. in.	
		Rotating-beam Test	"Rise of Temperature" Test
1	1.20 carbon, normalized	50 000	43 000
	sorbitic	92 000	88 000
3	0.52 carbon, normalized	42 000	41 500
	sorbitic	55 000	53 000
4	0.37 carbon, normalized	33 000	31 000
	sorbitic, treatment B	45 000	49 000
5	Chrome-nickel, treatment A	68 000	66 000
	treatment B	65 000	65 000
	treatment C	67 000	70 000
6	0.93 carbon, pearlitic	30 500	28 500
	sorbitic	56 000	53 000
	troostitic	98 000	90 000
7	3.5 nickel, treatment B	63 000	62 500
9	0.02 carbon, as received	26 000	26 000
10	0.49 carbon, sorbitic	48 000	48 000
50	Cold-drawn, as received	41 000	41 500
	annealed at 1300° F.	29 000	27 500
51	Hot-rolled, 0.18 carbon, as received	28 000	27 000
	reduced to 0.48 in.	35 000	38 500
	reduced to 0.44 in.	41 000	40 500
9	0.02 carbon, tested on Olsen-Foster reversed-torsion machine	12 500	13 000
	tested on Upton-Lewis reversed-bending machine	23 000	27 000

values obtained on the special machine there is also included a value for 0.02 carbon steel in torsion and a value in reversed bending. These values were taken from specimens tested in the Olsen-Foster reversed-torsion and Upton-Lewis reversed-bending machines respec-

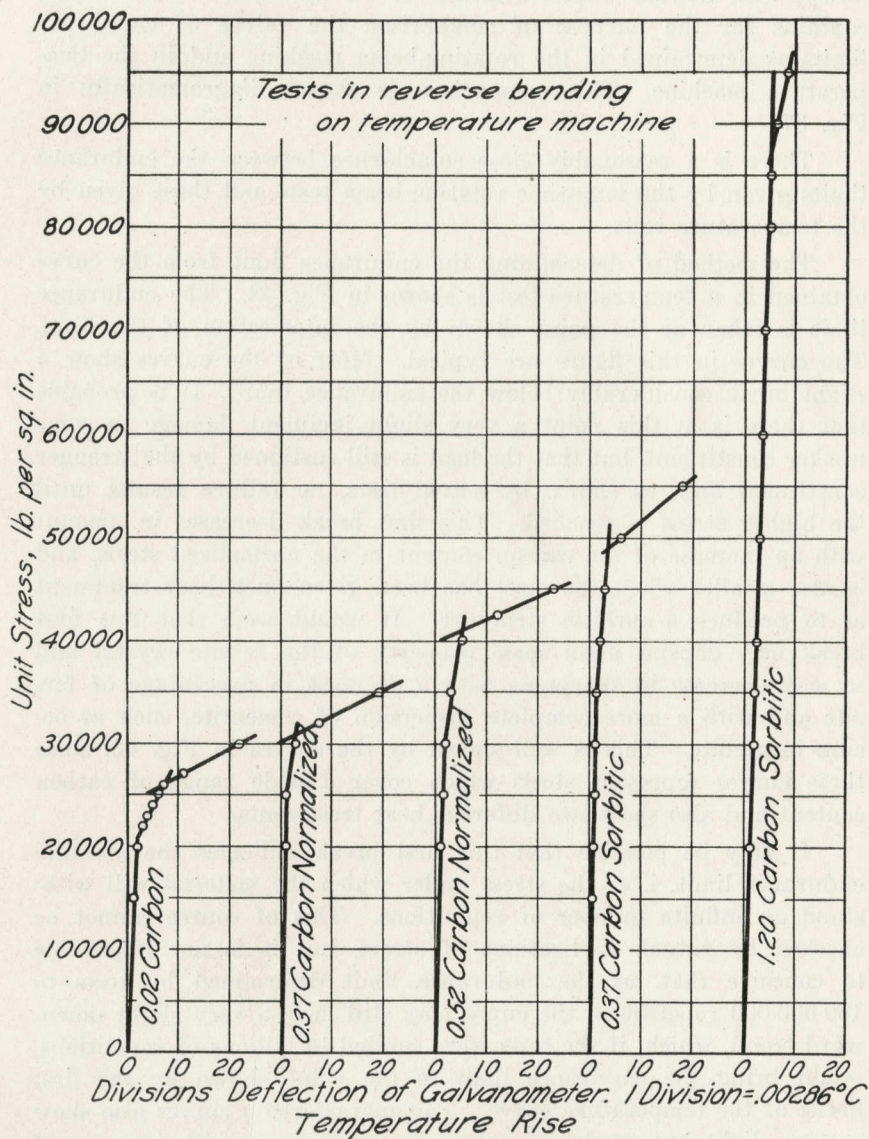

FIG. 43. REPRESENTATIVE DIAGRAMS FOR "RISE OF TEMPERATURE" TESTS

tively, with thermo-couples attached to the specimen. Table 8 also contains for the purpose of comparison the values of endurance limits as determined in the rotating-beam machine and in the temperature machine. This comparison is shown diagrammatically in Fig. 37.

There is a reasonably close coincidence between the endurance limits given by the long-time rotating-beam tests and those given by the temperature tests.

The method of determining the endurance limit from the curve obtained in a temperature test is shown in Fig. 43. The endurance limit is taken at the point shown by the intersection of the lines. The curves in this figure are typical. Most of the curves show a slight break considerably below the endurance limit. It is probable that there is at this point a very slight incipient damage in some weaker constituent, but that the load is still sustained by the stronger constituent and, as shown by actual tests, no failure results until the higher stress is reached. This first break decreases in amount with an increase of the carbon content in the normalized steels, and is also smaller when the steel has been given such heat treatment as to produce a sorbitic structure. It would seem that this first break may depend upon some property of the ferrite crystal and so may decrease in sharpness with a decrease in percentage of ferrite and with a more complete dispersion of cementite, such as occurs in sorbite. This is well shown by the curves in Fig. 43, since these curves represent steels which cover a wide range of carbon content and also show two different heat treatments.

It may be possible that this first break indicates the absolute endurance limit, i. e., the stress under which the material will withstand an infinite number of repetitions. This of course cannot be checked by actual applications of stress, but it is not impossible to conceive that, at the endurance limit determined by tests to 100 000 000 repetitions, the curve may still have a very slight downward trend, which, if the tests were carried to billions of repetitions, might bring the endurance limit to the value shown by the first break of the temperature curve. The characteristic curves also show a very slight but gradual increase in temperature with increase of stress below the endurance limit.

It is believed that a machine of this type, especially in conjunction with two or three rotating-beam machines, is a good piece of equipment for the average college or commercial laboratory, and that with such equipment the time and expense of fatigue investigations or commercial routine fatigue tests would be very materially lessened. With such equipment, using the temperature machine for a preliminary test, and the rotating-beam machine to obtain check results, it would be quite possible to determine endurance limits with a fair degree of accuracy within a few hours.

Problems worthy of further investigation include:

(1) An application of the principle of temperature measurement to a direct tension-compression fatigue machine and the determination of endurance limits under such stress.

(2) A more complete investigation of the first break in the curves by the use of more sensitive couples.

(3) A study of non-ferrous materials.

VI. SUBJECTS FOR FURTHER INVESTIGATION

29. *Effect of Repetition of Stress Not Reversed.*—The repeated-stress tests described in this bulletin have all involved complete reversal of stress. This is the severest type of repeated stress and is quite common in practice. It is, however, evident that many machine parts are subjected to varying stresses in which the variation does not involve a complete reversal. For example, stresses in a railroad rail vary from a maximum in one direction to a stress in the other direction of about one-quarter the magnitude of the maximum stress; chains are subjected to stresses varying from zero to a maximum. Comparatively little work has been done on the study of the effect of range of stress. In general it is estimated that a material which will withstand a completely reversed stress, S_1 , will withstand a stress of one kind only varying from zero to a maximum of S_2 equal to about 1.5 times the magnitude of S_1 , and that values between these limits may be obtained by interpolation.

Tests to determine the effect of range of stress are much needed, and in connection with the present investigation a machine has been designed and preliminary tests have been made under repeated stresses not completely reversed.

30. *Tests on Other Ferrous Metals.*—The tests recorded in this bulletin constitute a reconnaissance in the field of ferrous metals; they by no means constitute a complete study. Many other kinds of ferrous metals could well be studied, especially alloy steels, of which only two have been studied. Vanadium steels, molybdenum steels, and possibly tungsten and manganese steels at once suggest themselves. Methods developed in this investigation, especially the "rise-of-temperature" test, may be expected to shorten greatly the time required for determining endurance limits.

31. *Tests on Non-Ferrous Metals.*—This investigation in its first stages was definitely limited to the ferrous metals. The study should be extended to the non-ferrous metals—to brasses, bronzes, copper, aluminum, aluminum alloys, and possibly magnesium alloys.

Some tests on these metals have been made at commercial and government laboratories, but the data available are insufficient for drawing even tentative conclusions. Some experimental evidence tends to show that a higher number of repetitions of stress is necessary to develop the endurance limit for non-ferrous metals than for iron and steel.

32. *Effect of Heat Treatment.*—In the tests recorded in this bulletin, materials have been tested with various heat treatments. The object of variation was to produce certain characteristic structures in the metals. For many of the metals a much more detailed study of the effect of heat treatment on resistance to repeated stress should be made. It has been found in certain cases that the heat treatment which gives maximum static strength will not give maximum resistance to repeated stress, and many more tests should be made along this line. It is evident that the careful determination of the heat treatment which will give maximum resistance to repeated stress for any steel is a matter of great practical importance. The development of a reliable accelerated test for the endurance limit, such as the "rise of temperature" test, will greatly expedite such a study of heat treatments for ferrous metals.

33. *Direct Tension-Compression Tests.*—Under a bending stress only the outside fibers receive the maximum stress while the inside fibers of the specimens have a lower stress. A series of tests in which some specimens are subjected to direct tension and compression, while others are subjected to reversed bending should throw considerable light on the importance of the resisting ability of the understressed fibers of flexural members. A machine for producing repeated alternations of direct tension and compression has been designed and constructed and is being calibrated and adjusted.

34. *Strength Under Reversed Shearing Stress.*—In this bulletin test results are given for a few steels tested under reversed torsion in the Olsen-Foster machine. These specimens have been subjected to reversed shearing stress, and as pointed out in Section 15, "Some Factors Influencing the Endurance Limit," a ratio of endurance limit in shear to that in reversed bending of about 0.52 is indicated. Of late years it has become evident that shearing stress is frequently

the cause of failure in material, and a much more complete study of resistance to repeated shearing stress should be made. A machine for producing and measuring repeated alternations of shearing stress has been designed and constructed and is being adjusted and calibrated.

35. *Study of Mechanism of Fatigue Failure.*—The work of Ewing, Humphrey, Rosenhain,* and others on the development of slip lines in metals under stress has done much to explain why metals fail in fatigue. These experiments were generally made on soft metals; similar studies should be made on metals in the heat-treated condition, in order to examine the mechanism of fatigue more in detail. In this connection a study of the actual path of fracture in fatigue, with a microscope of high magnification, would be valuable.

36. *Effect of Repeated Understressing.*—Incidental to the study of overstressing in its effect on the endurance limit, discussed in Section 22, a few results were obtained on the effect of subjecting a specimen to a unit stress below the endurance limit and subsequently testing it at higher stresses. The few results observed indicate that such understressing may be beneficial in increasing resistance to fatigue, possibly by readjusting internal stress. Such tests also have a direct bearing on Bauschinger's theory of fatigue failure.

A study is contemplated in which a series of specimens will be stressed to, say, 10 per cent less than the endurance limit, for perhaps 10 000 cycles, and after this treatment subjected to various stresses in the usual manner, to determine whether any change has occurred in the endurance limit. By making several series of tests, using various percentages of understress, and with various numbers of cycles from 10 000 to perhaps 1 000 000, it will be possible to determine the effect of such understressing on the resistance to fatigue, and also the influence which the number of cycles of such understressing has on the result.

37. *Strength of Cast Metal Under Repeated Stress.*—The tests recorded in this bulletin, and nearly all other tests under repeated

*Rosenhain, "Metallurgy; an Introduction to the Study of Physical Metallurgy."

stress, have been made on rolled metal. The extensive use of steel castings and of castings of non-ferrous metals for stress-resisting parts makes some knowledge of the fatigue strength of such materials of importance. It is well known that the elastic strength of castings is low as compared with the ultimate strength, but there are no test results from which to judge whether this means that the strength under repeated stress is also low. Tests on castings would also give data concerning the effect of different crystalline structures on the fatigue strength of metals, since cast metals usually have a crystalline structure markedly different from rolled metals of the same chemical composition.

38. *Repair by Heat Treatment of Structural Damage Due to Repeated Stress.*—The question has often been raised whether a part which had been subjected to many repetitions of stress, a car axle after several years of service, for example, could be made “as good as new” by annealing, possibly followed by heat treatment. So far as is known no data exist on which to base an answer. An experimental study of this problem would quite possibly be closely allied to the study of the mechanism of fatigue failure. This general problem seems to be one of distinct importance.

VII. CONCLUSIONS

39. *Summary of Conclusions.*—The general conclusions to be drawn from the results obtained in the investigation may be summarized as follows:

(1) For the metals tested under reversed stress there was observed a well-defined critical stress at which the relation between unit stress and the number of reversals necessary to cause failure changed markedly. Below this critical stress the metals withstood 100 000 000 reversals of stress, and, so far as can be predicted from test results, would have withstood an indefinite number of such reversals. The name *endurance limit* has been given to this critical stress.

(2) In the reconnaissance tests made in the field of ferrous metals no simple relation was found between the endurance limit and the "elastic limit," however determined. The ultimate tensile strength seemed to be a better index of the endurance limit under reversed stress than was the elastic limit. The Brinell hardness test seemed to furnish a still better index of the endurance limit. The reason why the Brinell test, and, to a less degree, the ultimate tensile strength, seem to be better indices of the endurance limit than the elastic limit is not clear, and this result should be regarded as tentative. Elastic limits determined from compression tests and torsion tests gave no better index than did those from tension tests.

(3) The single-blow impact tests (Charpy tests) and the repeated-impact tests did not furnish a reliable index for the endurance limit under reversed stress of the ferrous metals tested.

(4) Accelerated or short-time tests of metals under repeated stress, using high stresses and consequent small numbers of repetitions to cause failure, are not reliable as indices of the ability of metal to withstand millions of repetitions of low stress.

(5) The endurance limit for the ferrous metals tested could be predicted with a good degree of accuracy by the measurement of rise of temperature under reversed stress applied for a few minutes. This relation is explicable in view of the intercrystalline and intracrystalline slippage under repeated

stress shown by the microscope. It is believed that this test, which is a development of a test proposed by Mr. C. E. Stroymer, can be developed into a reliable commercial test of ferrous metals under repeated stress. Its applicability to non-ferrous metals has not been investigated.

(6) Abrupt changes of outline of specimens subjected to repeated stress greatly lowered their resistance. Cracks, nicks, and grooves caused in machine parts by wear, by accidental blows, by accidental heavy overload, or by improper heat treatment may cause such abrupt change of outline. Shoulders with short-radius fillets are a marked source of weakness.

(7) Poor surface finish on specimens subjected to reversed stress was found to be a source of weakness. This weakness may be explained by the formation of cracks due to localized stress at the bottom of scratches or tool marks.

(8) Stress above the endurance limits, due to either a heavy overload applied a few times or a light overload applied some thousands of times, was found to reduce somewhat the endurance limit of two ferrous metals tested.

(9) In none of the ferrous metals tested did the endurance limit under completely reversed stress fall below 36 per cent of the ultimate tensile strength; for only one metal did it fall below 40 per cent, while for several metals it was more than 50 per cent. However, these metals were to a high degree free from inclusions or other internal defects; the specimens had no abrupt changes of outline, and had a good surface finish.

(10) It is well known that subjecting steel to a stress beyond the yield point raises the static elastic tensile strength to a marked degree. The effect is less marked on the endurance limit, although some increase was observed for 0.18 carbon steel with the surface polished after being stretched well beyond the yield point. Annealing of commercial cold-drawn screw stock was found to lower its endurance limit somewhat less than it did its static elastic strength.

(11) The test results herein reported indicate the effectiveness of proper heat treatment in raising the endurance limit of the ferrous metals tested. Here again it should be noted that an increase in static elastic strength due to heat treatment is

not a reliable index of increase of endurance limit under reversed stress.

(12) The phenomenon known as "fatigue" of metals under repeated stress might better be called the "progressive failure" of metals. The most probable explanation seems to be that such failure is a progressive spread of microscopic fractures. A nucleus for damage may be a very small area of high, localized stress, due to a groove, a scratch, or a crack; in other cases failure may be due to internal inclusions or irregularities of structure; it may be due to internal stress remaining after heat treatment; it may be due to a grain or group of grains unfavorably placed to resist stress; or failure may begin in the weaker grains of a metal whose structure consists of two or more kinds of grains; or it may, of course, begin in any portion of the metal which, by accidental overload or otherwise, is stressed to the yield point.

APPENDIX A

COMPARISON OF ENDURANCE TESTS BEYOND THE YIELD POINT WITH
ENDURANCE TESTS WITHIN THE YIELD POINT*

In connection with a course in graphic methods given at the University of Wisconsin, use was made of some data from endurance tests, and it was found that the deflections and corresponding cycles for rupture, obtained in tests involving stresses beyond the yield point, plotted as a straight line on logarithmic paper.

The tests in question had been performed on a machine of special design in which the specimen was gripped in the base of the machine, the projecting end of the specimen being deflected back and forth over a free length of 4 inches. By using various deflections it was possible to determine a relation between the deflection of the specimen and the number of cycles of stress necessary to cause rupture.

The fact that this relation was represented by a straight line when plotted on logarithmic paper suggested the possibility of extending the curve in order to show values of cycles for rupture at deflections which were known to be within the elastic limit. By this means it would be possible to get a relation between unit stress and cycles for rupture, because within the elastic limit the formula connecting unit stress and deflection for a cantilever beam is

$$D = \frac{SL^2}{3EC} \text{ in which}$$

D = deflection of the beam in inches,

S = unit stress in pounds per square inch in outer fiber, corresponding to maximum bending moment,

L = length, in inches, over which deflection takes place,

E = modulus of elasticity of the beam material,

C = distance, in inches, from the neutral axis of the beam to the outer fiber.

The correctness of the method of extending the deflection-cycles curve would depend upon whether the relation between deflection

*This appendix is based on former experimental work done by Professor Kommers, mainly at the University of Wisconsin.

and cycles for rupture as found by tests beyond the yield point held also within the yield point. If this proved to be the case, there would be available a method of establishing the relation between any unit stress within the elastic limit, and the number of cycles at this stress which would cause failure. The practical value of this proposed method would lie in the fact that the deflection-cycles curve could be determined in a few hours, thus rendering unnecessary the time-consuming methods ordinarily employed in establishing the relation between unit stress and cycles for rupture.

In order to prove or disprove the correctness of the proposed method it was decided to make tests on a series of three steels varying in carbon content, determining first the relation between deflection and cycles for rupture by tests beyond the yield point. The resulting deflection-cycles curve, plotted on logarithmic paper, would then be extended or extrapolated, and by means of the formula connecting unit stress and deflection a relation between unit stress within the elastic limit and cycles for rupture would be determined. A series of reversed-stress tests on a rotating-beam specimen would then be made to determine by direct experiment the actual relation existing. If these two methods gave the same value for the relation between these quantities, it could be considered that the proposed method was justified.

Table 9 gives the chemical analysis of the material used in the tests. It was received in the form of $\frac{7}{8}$ -inch rounds. Steel No. 1 was annealed at 850 degrees C. for one half-hour, and steels Nos. 2 and 3 were annealed at 800 degrees C. for one half-hour. The tensile strengths of the steels are given in Table 10.

TABLE 9

CHEMICAL ANALYSES OF STEELS FOR SPECIAL SERIES OF TESTS IN THE
WISCONSIN ROTATING-BEAM TESTING MACHINE

Steel No.	Carbon	Manganese	Silicon	Phosphorus	Sulphur
1	0.42	0.59	0.07	0.019	0.031
2	0.56	0.55	0.08	0.023	0.035
3	0.80	0.51	0.12	0.029	0.036

TABLE 10

RESULTS OF TENSION TESTS OF STEELS FOR SPECIAL SERIES OF TESTS
IN THE WISCONSIN ROTATING-BEAM TESTING MACHINE

Steel No.	Proportional Elastic Limit lb. per sq. in.	Yield Point lb. per sq. in.	Ultimate Tensile Strength lb. per sq. in.	Elongation in 2-in. per cent	Reduction of Area per cent
1	38 900	40 000	75 500	32.5	49.3
2	40 300	45 300	87 200	27.0	35.6
3	47 800	53 300	110 300	11.0	11.2

Note: Each value is the average of two test results.

Figs. 5 and 6 show the Wisconsin machine used for making the rotating-beam fatigue tests. The specimen, shown in Fig. 19, is fixed into the shaft of the machine, concentric with it, by means of nuts and set screws. The load on the specimen is applied through a ball bearing by means of a spring balance. It will be seen, therefore, that the specimen is loaded as a cantilever beam and is rotated with the shaft of the machine. The speed used was 1200 revolutions per minute.

When this machine was being tested the unit stress on different specimens was gradually lowered until finally a unit stress was reached which the specimen withstood for 100 000 000 cycles of stress without failure. This result was unexpected, and immediately suggested the probability that a metal had a well defined endurance limit.

The fact that a steel has apparently an endurance limit had a direct bearing upon the experimental work which had been planned. Because experimental data were lacking to prove the contrary, it had been assumed that the inclined straight line obtained when plotting on logarithmic paper unit stresses and cycles for rupture gave the correct relation between those quantities even for large numbers of cycles of stress. While this assumption would be disproved by the existence of a well-defined endurance limit, yet it seemed worth while to continue the experiments for the purpose of determining whether even the inclined part of the *S-N* diagram obtained for stresses below the yield point was related to that obtained for stresses beyond the yield point.

The upper half of Fig. 44 shows the curves obtained from the endurance tests on which the specimens were stressed beyond the yield point, while the lower half shows the curves obtained from the endurance tests in which the specimens were stressed within the elastic limit.

The equations for the straight lines in the upper half of Fig. 44 are as follows:

For steel No. 1,

$$N = \frac{56.9}{D^{2.57}} \quad (1)$$

For steel No. 2,

$$N = \frac{64.27}{D^{2.57}} \quad (2)$$

For steel No. 3,

$$N = \frac{26.18}{D^{2.77}} \quad (3)$$

in which D is deflection of the specimen in inches, and N is the number of cycles for rupture.

From these equations and the equation connecting deflection and unit stress within the elastic limit, taking 29 000 000 pounds per square inch as the value of the modulus of elasticity of steel, the following equations were derived:

For steel No. 1,

$$S = \frac{4\,896\,000}{\sqrt[2.57]{N}} \quad (4)$$

For steel No. 2,

$$S = \frac{5\,151\,000}{\sqrt[2.57]{N}} \quad (5)$$

For steel No. 3,

$$S = \frac{3\,314\,000}{\sqrt[2]{N}} \quad (6)$$

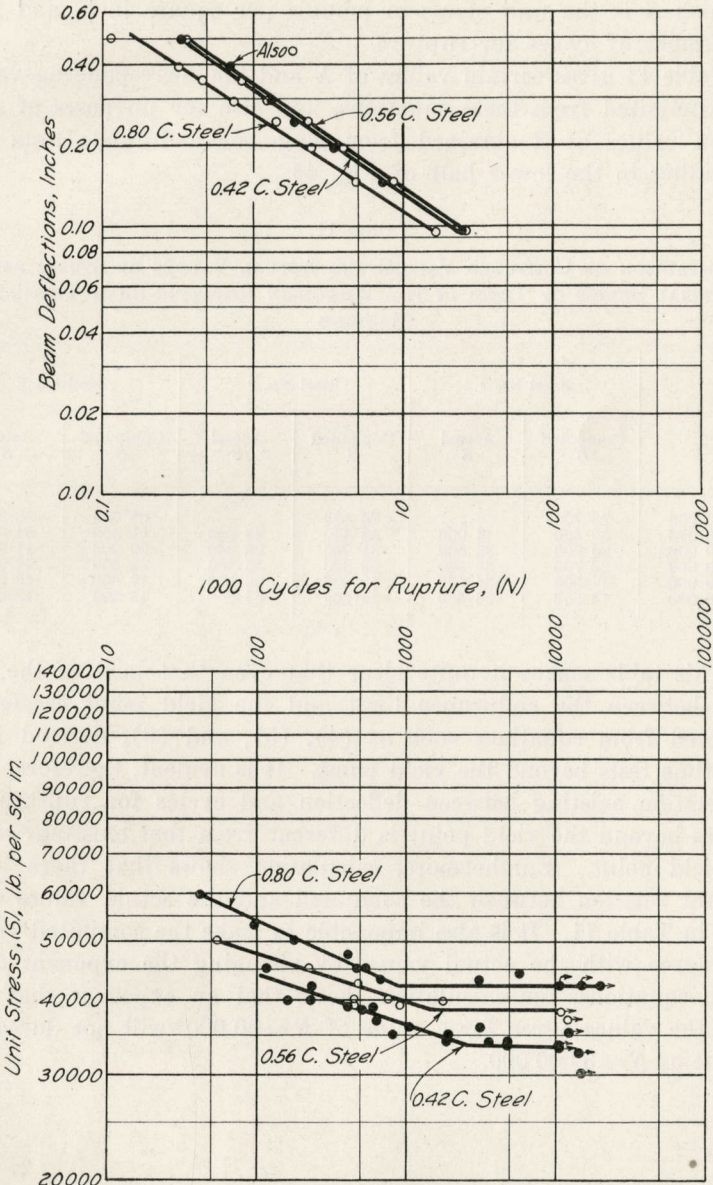

FIG. 44. S-N AND D-N DIAGRAMS FOR TESTS ON WISCONSIN ROTATING-BEAM TESTING MACHINE

Logarithmic abscissas give thousands of cycles for rupture

in which S is the unit stress in pounds per square inch, and N is the number of cycles for rupture.

Table 11 gives certain values of N and the corresponding values of S computed from these equations, and also for purposes of comparison values of S obtained from long-time endurance tests corresponding to the lower half of Fig. 44.

TABLE 11

COMPARISON OF COMPUTED VALUES AND ACTUAL VALUES OF STRESS FOR SPECIAL SERIES OF TESTS IN THE WISCONSIN ROTATING-BEAM TESTING MACHINE

N	Steel No. 1		Steel No. 2		Steel No. 3	
	Computed S	Actual S	Computed S	Actual S	Computed S	Actual S
50 000	72 700	76 500	63 600	58 300
100 000	55 500	44 000	58 400	43 000	51 900	54 000
500 000	29 700	38 500	31 200	38 000	29 000	44 800
1 000 000	22 700	36 500	23 800	36 800	22 600	42 000
2 000 000	17 300	34 500	18 200	34 800	17 600	42 000
3 000 000	14 800	33 500	15 500	33 800	15 200	42 000

This table makes it quite clear that even that part of the S - N curve between the endurance limit and the yield point cannot be predicted from equations such as (4), (5), and (6), derived from short-time tests beyond the yield point. It is evident, therefore, that the relation existing between deflection and cycles for rupture for stresses beyond the yield point is different from that existing within the yield point. Furthermore, calculation shows that there is no constant relation between the computed and the actual values of S given in Table 11. It is also impossible to make the computed values of S agree with the actual values by changing the exponent of N in the equations, for calculation shows that an exponent that will make the values agree for a value of $N=50\ 000$ will not do so for a value of $N=3\ 000\ 000$.

APPENDIX B

FATIGUE PHENOMENA IN METALS

The following pages give the substance of a progress report prepared by the Engineering Division of the National Research Council Committee on Fatigue Phenomena in Metals and published in "Mechanical Engineering" for September, 1919.

This committee of the National Research Council was made the Advisory Committee for the Joint Investigation of the Fatigue of Metals. Those paragraphs of the 1919 progress report which deal with plans for an investigation of fatigue phenomena in metals are not printed here, since they are given in substance either in the parts of this bulletin dealing with test results or in Chapter VI, "Subjects for Further Investigation." It should be remembered that the progress report given in this appendix was written before the main part of the bulletin, and that it is to be expected that the results of the investigation will be found to modify some of the views given in the first progress report.

In this appendix references are made by number to articles listed in the Bibliography given in Appendix D.

Metal parts of machines, such as springs, shafts, crankpins, and axles, occasionally fail suddenly while only subjected to conditions of ordinary service. Not only does failure occur suddenly, but the part about to fail shows no ordinary evidence of weakness. The broken parts when examined are seen to be broken off short, and without general distortion, even though the material may show high ductility in ordinary tests. Such failures are found only in parts subjected to stress repeated many times—to "vibration," as it is sometimes stated—and the phenomena which are involved in the final failure of metal through oft-repeated loading are known as "fatigue" phenomena of metals.

The phenomena of fatigue failure have recently given rise to some perplexing problems in connection with the design and service of airplane-engine crankshafts, the hulls of steel ships, axles and shafts in railway cars, motor cars and trucks, and other machine parts. The question whether structural parts subjected to repeated stress are in danger of fatigue failure has been discussed at considerable length. The danger of fatigue failure seems to be an important factor in determining the safety of structural parts, with the possible exception of parts subjected to reversal of stress. The reason for this is probably found in the relatively small number of loadings which most structures are

called upon to withstand, and in the fact that most of the loadings are below the maximum working value. On the other hand, the danger of fatigue failure is a major factor in determining the safety of many machine parts.

The problem of fatigue of metals engaged the attention of engineers seventy years ago, in connection with car axles and members of iron railway bridges. It was early recognized that high stress tends to cause, or at least to hasten, fatigue failure, and about 1860 Wöhler's famous investigations 132(b) were undertaken to determine the relation between intensity of fiber stress and the ability of materials to resist fatigue under repeated stress. Wöhler's tests occupied some eleven years, and remain to this day the most thorough tests on record. Wöhler investigated metals under direct tension, under bending, and under torsion (shear). For some of his tests the stress varied from zero to a maximum and for others the stress was reversed. The results of Wöhler's tests may be summarized as follows:

- (1) A machine part or structural member may be ruptured by the repeated application of a load which produces a computed fiber stress less than the ultimate strength of the material as determined by a static test.
- (2) The greater the range of stress, the lower the limiting fiber stress to insure against rupture after a very large number of repetitions.
- (3) To insure against rupture after a very large number of repetitions of loading causing complete reversal of stress, the limiting fiber stress is but little greater than one-half the limiting fiber stress for a very large number of repetitions of stress varying from zero to a maximum.

Following Wöhler the famous Bauschinger⁹ published a series of conclusions on fatigue, and various other investigators, notably Gerber,^{125(b)} and Weyrauch and Launhardt,^{68(d)} gave early interpretations of the experimental results of Wöhler and Bauschinger.

In these earlier experiments several facts seem noteworthy. The prime object of the investigators was to deduce laws of fatigue for railway bridges and car axles. The problem of fatigue in high-speed machine parts had not then appeared. These investigators carried their tests far enough to cover the number of repetitions required by the structures of their day and assumed that having done so they had established an endurance limit. Reading their conclusions carefully, the statement does not seem to be made that material which passed their tests would stand an *infinite* number of repetitions. The term generally used is "indefinite" or "very large," and the number corresponding is from ten to fifty millions. For the problem which they investigated their tests seem to give safe guides for practice, but today, with the advent of modern high-speed machinery, some parts of which must be as light as possible, and the extension of the fatigue problem to such members as the cranks and the connecting rods of gas engines and the shafts of steam turbines, the number of repetitions of stress which a machine member may be called upon to undergo is very much increased. This fact is illustrated by Table 12, which gives a statement of the approximate service required from various structural and machine members.

Investigations have been made in recent years by Howard,⁵⁶ Stanton,^{112, 113, 114, 115} Basquin,⁸ Smith,¹⁰⁷ Eden, Rose and Cunningham,²⁸ Kommers,⁶⁸ Mason,⁷⁴ Moore and Seely,⁸³ and others. The efforts of these investigators

TABLE 12

APPROXIMATE SERVICE REQUIRED OF VARIOUS MEMBERS OF STRUCTURES
AND MACHINES SUBJECTED TO REPEATED STRESS

Part of Structure or Machine	Approximate Number of Repetitions of Stress in the "Lifetime" of the Structure or Machine
Railroad bridge, chord members	2 000 000
Elevated-railroad structure, floor beams	40 000 000
Railroad rail, locomotive wheel loads	500 000
Railroad rail, car wheel loads	15 000 000
Airplane-engine crankshafts	18 000 000
Car axles	50 000 000
Automobile-engine crankshafts	120 000 000
Lineshafting in shops	360 000 000
Steam engine piston rods, connecting rods and crankshafts	1 000 000 000
Steam-turbine shafts, bending stresses	15 000 000 000

have been toward the study of modern materials, refinements in methods of testing, and interpretation of results. The limits of actual tests have not been extended to modern requirements, and the problem still remains of obtaining test data for much longer endurance of fatigue than was contemplated by Wöhler. Under the most favorable conditions conceivable such data will be obtained very slowly, and meanwhile there must be faced the problem of determining safe stresses for very large numbers of repetitions by extrapolation from previous test results.

MACHINES FOR TESTING FATIGUE STRENGTH

Fatigue tests cannot readily be carried out with ordinary "static" testing machines. It is, of course, possible to repeat loadings on a test specimen in such a machine, but the process is very slow. Such a machine equipped with an ingenious automatic arrangement for applying and releasing load was used by Van Ornum¹²⁸ in fatigue tests of concrete in compression, but the time required for even a hundred thousand cycles of stress was very great.

A very simple repeated-stress testing machine acts by the application and removal of a weight to the end of the long arm of a simple or compound lever, the specimen carrying load at the short arm. Such a machine was used by Berry in fatigue tests of concrete in compression. In a machine of this type the load must be applied slowly, else there will be inertia forces set up by the impact of the weight as it is let into place.

A common type of repeated-stress testing machine is one in which a calibrated set of springs resist the tensile, compressive, flexural, or torsional stress set up in the specimen, and the deformation of the calibrated set of springs gives a measure of the force or moment acting on the specimen. Fig. 45(a) diagrammatically illustrates this type of machine which was used by Wöhler and has since been used by many other experimenters. The Upton-Lewis machine is of this type and extensive use was made of it in torsion tests carried on by McAdam.^{85(b)} This type of machine permits a fairly high rate of repetition of cycles of stress, and machines which have been run at 1000 repetitions per minute have given results apparently trustworthy.

The most common type of machine for reversed bending stresses uses a circular specimen acting as a rotating beam. This type was used by Wöhler, and also by many later investigators. Fig. 45(b) illustrates such a machine. The specimen is in the form of a bar of circular section, to which bending stress is applied by weights. The specimen is rotated by means of a pulley. At any instant the outer fibers are subjected to a stress varying from tension on one side to compression on the other, and the fiber stress at any point passes through a cycle of reversed stress during each revolution. As shown, the specimen is loaded at two symmetrical points of the span, and between these two points the extreme fiber stress is constant for each element along the bar. This type of machine permits high speed of reversal of stress, speeds up to 2000 revolutions per minute having been successfully used.

British experimenters have used repeated-stress testing machines in which varying stress was applied to a specimen by means of the inertia of reciprocating parts. Fig. 45(c) shows such a machine, which can be used at high speeds. However, the speed must be very closely controlled, as the inertia forces vary with the square of the speed. Moreover, friction on the guides causes some slight uncertainty as to the magnitude of stress set up at each stroke of the crank.

A repeated-stress testing machine depending on centrifugal force to produce cycles of stress is shown in Fig. 45(d). It is evident that as the eccentric weights revolve the specimen will be placed alternately in tension and in compression. This machine has been used by J. H. Smith.^{107(a)} Its characteristics are much like those of the inertia type; in fact, it is a special form of inertia machine.

A type of machine used by Arnold and later by other experimenters is shown in Fig. 45(e). In this machine a specimen is repeatedly given a certain deflection. Usually this deflection is sufficiently large to stress the material well beyond the yield point, and no very definite stress can be computed. This machine is used mainly for short-time tests.

Another short-time-test machine uses the repeated impact of a small hammer. The claim is made that impact loading emphasizes local flaws better than a load which is more gradually applied, and that thus it *indirectly* gives a better index of fatigue strength. Data, however, are lacking to prove or disprove this claim.

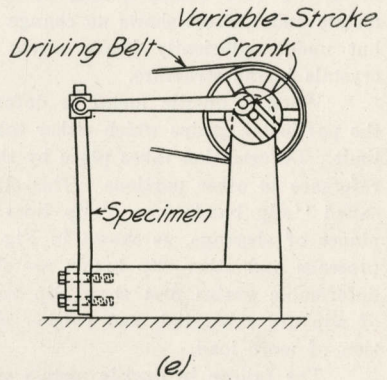
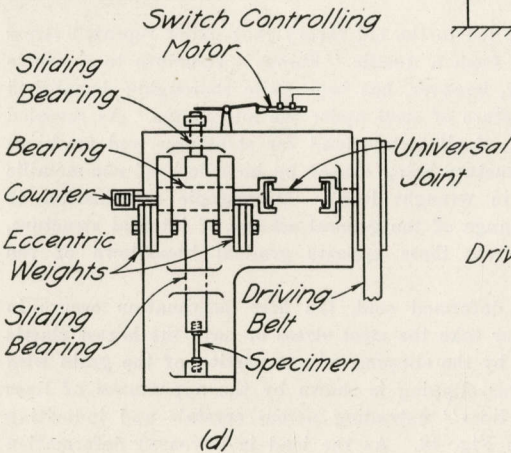
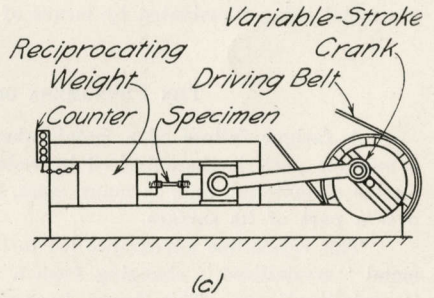
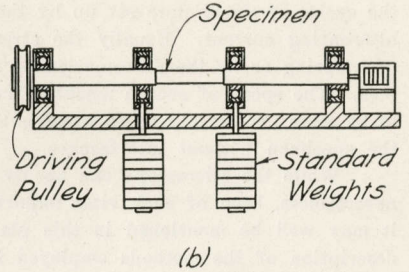
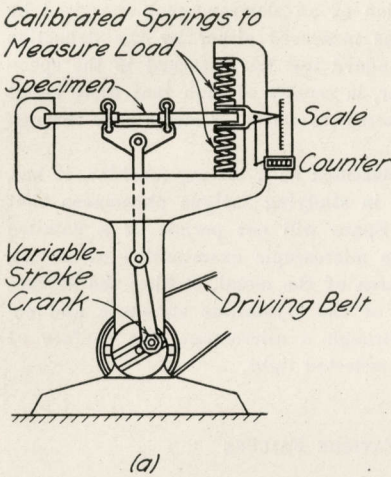

FIG. 45. DIAGRAMS OF TYPICAL REPEATED-STRESS TESTING MACHINES

Various repeated-stress testing machines have been constructed in which the cycles of stress were set up by the action of an electromagnet energized by alternating current. Usually the stress was measured either by the deflection of a spring or by the deformation of a standard test bar attached to the specimen. The speed of such a machine, however, is usually so high that there seems to be some uncertainty as to whether the successive waves of stress pass through the specimen without interference.

While the microscope can hardly be classified as a testing machine, it has, nevertheless, been of such vital importance in studying fatigue phenomena that it may well be mentioned in this place. Space will not permit of a detailed description of the methods employed in the microscopic examination of metals, but the process involves polishing a small area of the metal, etching the surface with some reagent to bring out the lines of the crystalline structure, and examining and photographing the surface through a microscope, the surface of the metal being illuminated by means of a reflected light.

THE PHENOMENA OF FATIGUE FAILURE

A fatigue failure of a metal, whether it occurs in a test specimen or in a machine part, is characterized by suddenness, lack of warning, apparent brittleness of material, and, in many cases, a fracture with a crystalline appearance over a part of its surface.

This crystalline appearance led to the old theory that under repeated stress metal "crystallized," changing from a ductile "fibrous" structure to a brittle "crystalline" one. This theory, however, has been quite thoroughly demolished as a result of study of the structure of steel under the microscope. As revealed by the microscope the structure of all metals used for structures and machines is crystalline, any "fibrous" structure being caused by inclusions of non-metallic impurities (for example, slag in wrought iron). Microscopic examination of metals under stress shows no change of the general scheme of internal structure, but under sufficiently heavy stress there appears gradual breakdown of the crystals in the structure.

When a ductile metal is deformed cold, the first deformation occurs in the particular grains which either take the most stress or have the lowest elastic limit. Deformation takes place by the slipping of one portion of the grain with reference to other portions. This slipping is shown by the appearance of lines called "slip bands" or "slip lines" extending across crystals and indicating planes of cleavage, as shown in Fig. 46. As the load is increased deformation proceeds and other slip bands are formed, the law being that the most easily deformable grains first show slip bands. Gradually the most favorable planes of slip are exhausted, and further slippage can take place only with the addition of more load.

The failure in ductile metals subjected to repeated stress takes place with substantially no general deformation. There is, however, considerable local deformation over microscopic areas, evidenced by the appearance of many slip

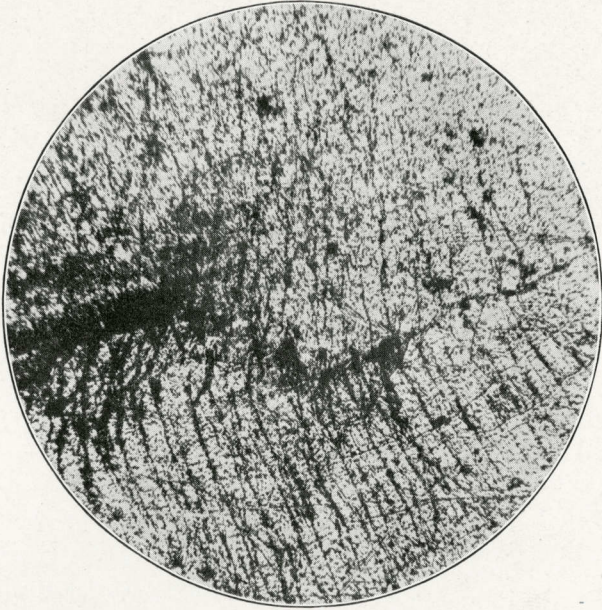

FIG. 46. MICROGRAPH SHOWING SLIP LINES IN IRON
Magnification 80 diameters

bands on a polished surface of the metal after the application of repeated stress. These slip bands appear after a small number of reversals of stress with relatively large loads, and may not appear at all with slight loads. The slip bands may first appear either in the interior of a grain or at the grain boundary. As the number of applications of stress increases more slip bands appear, and those first appearing usually lengthen and widen. Under the microscope and with normal illumination the general surface becomes blacker as the number and width of the slip bands increase. In ductile metals fatigue failure is almost exclusively through the grains themselves rather than at the grain boundaries, and the first slip bands to appear do not necessarily form a part of the final path of rupture. Failure seems to take place by the uniting of slip bands into cracks. When the first grain develops a crack extending across its entire width, added stress promotes the extension of this crack into adjacent grains on both sides, although the orientations of these grains may be and usually are such that the crack must extend itself at an angle to that in the initial grain. The general tendency is for these slip bands to follow the lines of cleavage of the particular grain in which they occur. Often incipient fracture is found in many grains adjacent to the final path of rupture, indicating that had rupture not taken place where it did, it would have soon taken place in some other adjacent part.

Such observations by means of the microscope indicate that *localized deformation* is the primary cause of fatigue failure in ductile metals, but it does not necessarily follow that the formation of one slip band under repeated stress will indicate eventual fracture if the loading is continued; one grain may appear to have a greatly reduced elastic limit because of internal strains or peculiarly unfavorable orientation. It is not certain that there is a limiting load below which fatigue will never take place.

Materials classified as brittle have very little permanent deformation under static stress, and under repeated stress the progressive fracture of brittle material might take place, not by slipping within crystals, but by tensile fracture of crystals. There has been practically no study made of the fracture of brittle materials under repeated stress, and it would be instructive to have tests carried out on brittle amorphous materials such as fused silica and on brittle crystalline materials like marble or tungsten. It is gradually being recognized that the breaking load of a specimen is a complex matter, and depends, among other things, on the time of application of the load. Mere duration of static loading, however, does not have an effect at all comparable with repetition of loading in reducing the breaking load. It seems evident that the distribution of stress in some brittle materials is very much less uniform than in ductile materials, and that fractures in brittle materials start on areas of high stress, whereas in ductile materials the high stresses are relieved by local yielding. A more complete understanding of the mechanism of rupture in brittle materials would doubtless be of great value.

When the action of metal under repeated stress is considered from the viewpoint of the internal strains and accompanying stresses in the material, a

radical difference is seen in the behavior of material under static load and under repeated load. In a general way we may consider any structural or machine part as subjected to static conditions if the load on it is applied gradually and is not repeated more than a few hundred times; the part may be considered as subjected to fatigue if the load on it is applied, say, one hundred thousand times or more; and for intermediate conditions of loading the phenomena characteristic of both kinds of loading would be present.

We must look upon steel as filled with a multitude of minute flaws. These flaws are developed in the solidification of the material. In static testing, steel under stress of about half its ultimate strength passes into a semi-plastic condition, in which there is a gradual flow of the material. Under such conditions the small flaws have almost no effect upon the flow or upon the static strength. When steel is loaded to moderate stresses the yielding is almost entirely elastic, but in general a small portion of it is inelastic, energy being taken up by the steel itself. If the specimen can be loaded a great number of times without heat loss its temperature will increase. If it is set vibrating in a chamber free from air it will stop vibrating in a short time, due to the absorption of energy. In such cases the stress-strain curve appears to be straight and the curve for the removal of the load may be practically identical with that for the application of load, but still these other effects show loss of energy in the steel itself.

This loss of energy is doubtless due to small displacements at these flaws, which are not reversible. Under alternate loadings these displacements are made back and forth. Energy is continuously being absorbed in the location of these small flaws, and it is perfectly natural that they should increase in size. We must look upon these extensions of the flaws as occurring in a great many parts of the steel. If the stresses are small the increase in size of these flaws is practically negligible, but if the stresses are larger the increase is rapid, and later on in the history of the piece under test, very rapid, and finally the strength of the piece is terminated when a sufficient number of these flaws have connected so as to form an area of very great weakness.

For static loads all the above is of little consequence with a ductile metal; but it is of consequence in the case of a brittle metal like cast iron, which has a remarkably low strength in tension in comparison with its compressive strength. Ductile metals may be considered as having a very high value for cohesion with a rather low coefficient of friction—or whatever corresponds to that—so that these metals begin to slide on diagonal planes without actual fracture under high local stress.

When a ductile material is loaded it may be subjected to stresses whose average values for small areas are not very different for parts that are a tenth of an inch apart; but there is a multitude of tiny spots whose fiber stresses are 2, 3, 4, or 10 times the average value,^{61, 92, 21(1)}. This holds so long as elastic conditions obtain. As the applied stress increases some of these stresses increase in like ratio, but not in like increments. At moderate applied stresses these special stresses reach inelastic conditions and slipping occurs. If the average stress is now entirely removed, we may assume that the unloading takes

place in a similar manner. The small spots unload first in an elastic manner, but at a different rate than the remainder of the material. They will unload approximately at the same rates as they used in taking stress, namely, 2, 3, 4, or 10 times the normal rate. For the unloading they have about twice the range of stress that they had in the loading before inelastic action is set up. Some of them will reach the opposite limit and slip part way back again, while some of them may not be subject to this return slip of inelastic action, but will retain in the unloaded state a stress distribution of the opposite kind. Either of these actions will give rise to hysteresis and to slight change of dimensions, usually, however, too small to be detected.

In all of the foregoing the main parts of the material have not been subjected to stresses which give inelastic action. If the loading is repeated without reversal, the spots that slipped on the first unloading will be subjected to further slipping both on loading and on unloading, but the areas that suffered no slipping on the first unloading should show no further inelastic action unless the loading is reversed. If the loading is reversed, however, all the particles that slipped in the first loading will slip on the reverse loading, so that with repetition a larger number of spots undergo this slipping action than is the case with loading which is not reversed. This explains the shorter life under reversed stress than under repeated stresses in one direction only.

If the fractured surface of a "rotating beam" specimen made of ductile metal and broken by repeated stress is examined, it is usually seen to be made up of two parts: (1) near the extreme fibers there is a dark surface with a dull, lusterless appearance, while (2) the remainder of the surface has a bright crystalline fracture. If these are examined more carefully it is found that their principal difference is in the size of the small flat surfaces that constitute the fracture. The center portion of the area has comparatively large surfaces, giving a crystalline effect, while the dull gray portion has very small surfaces of fracture.

An explanation of this is that the flaws in the outer portion of the surface have connected to form an annulus, whose rugged face is roughly at right angles to the axis of rotation. This has doubtless occurred slowly, and has started from many centers, thus giving the rough face. After this slow growth of flaws into an annular fracture has been accomplished the specimen has become very weak and the stresses have become so large at the fracture that they suddenly tear the metal in two on the natural surfaces of cleavage of the crystal grains.

The center portion of this fractured surface does not differ from the crystalline surface at the bottom of a cup in an ordinary static tension fracture, except that the crystalline surfaces are somewhat larger. This is to be explained by the fact that in an ordinary tensile test the material at the fracture has elongated something like 100 per cent, so that the crystal grains have become of smaller cross-section and will naturally show smaller facets on fracture, whereas, in a fracture of the endurance specimen, the material has had no chance to elongate and the crystalline grains have their normal size, which will be

shown in fracture. It is not the crystalline portion of the broken specimen which has failed primarily by repeated stress, but the dull portion. In the crystalline part of the fatigue fracture and in the crystalline part of the static tension fracture the failure seems to be of the same nature, namely, a failure in cohesion.

In considering the phenomena of fatigue failure it may be well to call attention to the fact that there is an intermediate type of failure of ductile material in which both plastic action and the development and spread of microscopic flaws are present. Such failures sometimes occur in staybolts, boiler sheets between rivet holes, and other parts occasionally subjected to very severe local distortion.

LOCALIZED STRESSES UNDER STATIC LOADING AND UNDER IMPACT LOADING

When a machine member or structural part is loaded gradually a state of strain and accompanying stress is set up throughout it. In a general way the distribution of stress is similar to that given by the theory of elastic action which serves as a basis of our formulæ for computing stress and strain. There are, however, many deviations from this distribution due to non-homogeneity of the material and to irregularities in outline such as projecting corners, scratches, and tool marks. When load is applied the general behavior of the piece as indicated by careful measurements of stretch, compression, twist, or flexure conforms to that required by the common theory of elastic action, but there are doubtless many localized strains which cannot be detected, even by the use of delicate micrometer measurements. It is to be recalled that in measuring strains it is necessary to use a gage line of considerable length, with the result that the observed strain is an average value along a relatively long line. The localized stresses, corresponding to these undetected localized strains, are not of any great importance under static load. When the load is increased to such an extent that a considerable portion of the piece is stressed beyond the elastic limit, the distortion of the piece increases abnormally and the piece may be considered to have reached its yield point. After this limit is passed the distribution of stress is much modified, and for parts made of ductile material the abnormal distortion at the yield point usually gives warning of structural damage before complete failure occurs.

Under impact loading, which is merely loading applied in a very short space of time, the action is somewhat similar to that under static loading, except that ductile material may offer a higher resistance to very rapid fracture than it does to fracture occurring gradually through a period of several minutes. Impact fracture, moreover, may emphasize somewhat the localized stresses set up at places where the structure of the material is non-homogeneous, or at places where there are sharp notches or deep scratches in the surface of the piece. Under slowly applied load there is opportunity for considerable adjustment and equalization of stress after the yield point is passed; under impact load there is probably less equalization on account of the rapidity of the action,

and hence the localized stresses are higher and more effective in causing failure. This explanation of the action under impact is given here because repeated stresses also emphasize the effect of high localized stress, though for an entirely different reason.

TESTS AND CRITERIA FOR FATIGUE STRENGTH

It was formerly the common opinion that the determination of the elastic limit of a material by means of a static test in a testing machine gave a reliable test for the fatigue-resisting qualities of the material, and that the material could withstand an infinite number of repetitions of stress lower than this elastic limit. Tests at various laboratories, however, have quite thoroughly disproved this idea, and have thrown grave doubts on the reliability of the elastic limit as an index of fatigue strength. The term "elastic limit" has always been rather loosely used, and covers several quite different stresses.^{79(a)} The value determined for the elastic limit for any material depends on the sensitiveness of instruments used and the accuracy of plotting results, and the elastic limit as determined by such a test in a testing machine is determined by the average behavior of the material over a considerable length, while the process of fatigue failure may be going on over a section so small that it does not appreciably affect the readings of the measuring instruments used. In several laboratories comparative repeated-stress tests of different materials have shown higher fatigue resistance for the material with the lower elastic limit.^{23, 80, 82}

Bauschinger in his classic experiments showed that the elastic limits in tension and compression as determined by ordinary testing-machine tests were variable limits, their value depending on the treatment of the material during fabrication. He called such limits "primitive" elastic limits, and showed that when a specimen is subjected to gradually increasing range of alternating stress there are soon set up two elastic limits in the bar—one in tension and one in compression. He called these limits, which may have values widely different from the "primitive" elastic limit, the "natural" elastic limits, and the range between them the "elastic range." He also showed that a test specimen will stand several million repetitions of this elastic range of stress without failure, and proposed the "natural" elastic limits as indices of the fatigue-resisting strength of the material. J. H. Smith^{107(c)} has developed a somewhat simplified process of determining the elastic range. This elastic range seems a more reliable index of fatigue strength than the ordinary "primitive" elastic limit, but the reliability of indices of fatigue strength based on determinations of any elastic limit by testing-machine tests is open to question on account of the possibility that localized fatigue failure may be in progress without affecting the readings of the instruments used in static tests.

Wöhler used as an index of fatigue strength the "endurance limit" of material as determined from a series of fatigue tests with different intensities of stress. He used the method of plotting values of stress (S) against numbers

of repetitions required for fracture (N) and determining by eye where this $S-N$ curve became "practically horizontal." Other investigators have plotted values of S against values of $1/N$ or of $(1/N)^n$ and by extending the diagram till it intersected the axis of ordinates have determined an assumed endurance limit for an infinite number of repetitions of stress. Both of these methods involve enormous extrapolation of test data. Moreover, widely different endurance limits can be determined from the same test data by different methods of plotting values.⁸³ The tendency to irregularity of test results under low stresses makes the decision whether the $S-N$ curve is horizontal or slightly sloping downward one of very considerable uncertainty.

It has been proposed by various experimenters to compare the fatigue-resisting qualities of different metals by short-time tests with stresses well beyond the yield point of the material. Such tests are quickly and easily made. Under such stresses, however, the action of the material is partly a plastic flow. Such tests give good promise of determining fatigue strength and toughness under occasional overload for parts such as staybolts, which in their ordinary service are subjected to rather severe distortion, but it is not at all certain that such tests give a reliable index of resistance of machine parts under ordinary working stresses.⁸⁰

It has been proposed by various laboratories to compare the fatigue strengths of various materials by comparing their life under repetitions or reversals of some standard stress, usually less than the elastic limit of the material as determined by a static test. A somewhat similar standard proposed is to determine the stress which will cause failure under a given number of reversals. Standard stresses proposed for steel are 38 000 pounds per square inch (reversal) and 25 000 pounds per square inch (reversal). One million reversals has been proposed as a standard "life." These two types of test approach working conditions more closely than do the short-time, high-stress tests described above. However, they determine only one point on a $S-N$ diagram for a material and do not indicate how fatigue endurance changes with change of stress.

A comparative study of fatigue strengths of various materials can be made from a $S-N$ diagram plotted on logarithmic paper. Up to about 1 000 000 repetitions of stress logarithmic $S-N$ diagrams fall quite closely along straight lines, and from the ordinates and slopes of these lines the behavior of materials under various intensities of stress can be studied. Tests may conveniently be made with stresses at about the yield point of the material, at stresses about 20 per cent lower, and at one or two intermediate stresses.

Various other possible tests have been proposed for determining the fatigue-resisting strength of a material, but no test has been proved to be of sufficient reliability to be accepted as a standard. A number of tests, however, seem worthy of experimental study.

The rate of dying out of vibrations in a "tuning fork" specimen of the material has been suggested as a possible index of fatigue strength.¹⁵ It is assumed that the gradual dying out of vibration is due largely to loss of energy

spent in inelastic action in the material, and that such inelastic action is a measure of the fatigue weakness of the material. Test data are lacking to determine the value of this test, but it seems worthy of study.

Tests of magnetic permeability have also been proposed to locate internal flaws in the material and thus indicate its relative fatigue strength. The entire subject of the correlation of the magnetic and the mechanical properties of iron and steel is a promising field of investigation.¹⁹

The rise of temperature under repeated stress has likewise been proposed as a measure of fatigue resistance.^{118(b)} Theoretically, if a specimen is subjected to reversed elastic stress no change in temperature should take place, and it has been proposed to determine the endurance limit for metals at that stress which causes the first noticeable rise in temperature after some thousand or more reversals. A practical difficulty in using this test is to secure proper heat insulation for the specimen. This test seems worthy of study, however, especially if employed in an inertia type of testing machine (see Fig. 45[e] and [d]).

The detection of the appearance and growth of "slip lines" in a specimen subjected to repeated stress gives some promise of furnishing a reliable test for fatigue strength. Slip lines appear long before fracture occurs, and if their appearance or the rate of their spread can be shown to be an index of fatigue strength it seems possible that a feasible laboratory test may be devised. The search for slip lines over any considerable area would, however, be very tedious.

Impact tests, usually on notched bars in bending, have been proposed as an index of fatigue strength. The actions under impact failure and under repeated stress are very different, the first giving a sudden break of the entire cross-section of the specimen, and the second a gradually developing fracture. Both failures, however, seem to be affected by localized flaws or irregularities in outline, and though no definite correlation between fatigue strength and strength to resist impact has been established, yet such tests are worthy of study. Repeated-impact tests have also been proposed to determine fatigue strength, but whether such tests have any advantage over short-time tests under non-impact loads is not known.

In all tests to determine fatigue strength it is of the highest importance to secure uniformity of surface finish between the different specimens to be compared. Probably this can best be done by polishing the surface of the specimens where failure is expected.

There is today no short-time test accepted as a standard test for fatigue strength; but the development of such a test, and the establishment of its reliability, would unquestionably be of very great service to testing engineers.

LOCALIZED STRESS AND ITS INFLUENCE IN PRODUCING FATIGUE

The ordinary formulæ and methods of analysis used in computing the fiber stress in a machine part or structural member are based on the assumption that the material is homogeneous throughout, and that the cross-section

of the member is either constant or that it changes its dimensions so regularly and gradually that there is no appreciable localized fiber stress at sections of rapid change. For structures and machines of ductile material subjected to not more than a few hundred loadings, such assumptions are reliable, because localized stresses do not appreciably affect the general deformation of a member, nor do they under ordinary working conditions cause trouble before the member has been subjected to some thousand or more repetitions of load. For nearly all parts, however, high localized stresses are present. Internal flaws may cause such localized stresses. This is shown by mathematical analysis of stress in plates with holes in them⁶¹ and by direct experiment on such plates.^{92, 21(1)} External irregularities of outline may cause localized stress. Under bending or twisting a member with a sharp reëntrant angle in its outline theoretically develops an infinite stress at the root of the angle,²⁹ and actually both mathematical analysis and direct experiment show that very high localized stress may be caused by sharp grooves or scratches on the surface of a machine part or structural member.

It has been stated above that for parts subjected to a few loadings localized stresses are not of great significance. The case is quite different, however, for parts subjected to thousands of loadings. High localized stress may cause a crack to start, either directly or by "cold-working" the material where the localized stress exists until the material becomes brittle. This crack forms an extension of the discontinuity of the material which caused it, and under repeated stress tends to spread still more rapidly. This tendency is illustrated by the action of a piece of plate glass in which a crack has started. In most cases under any repetition of load the crack spreads, and will cause final fracture of the glass. A fatigue failure under repeated stress is a progressive failure. This spreading of cracks to cause failure explains why under fatigue even ductile materials snap short off. Failure does not involve plastic flow of considerable masses of metal, but only of microscopic masses near the crack, and final fracture comes suddenly just as if the member were cut half off by means of a saw cut and then bent. The importance of avoiding localized high stress in members subjected to repeated stress can hardly be overemphasized. Homogeneity of internal structure, smoothness of external surface, and avoidance of sudden changes of cross-section may be more important in the construction of machine parts subjected to repeated stress than is high static strength of material.

Shoulders of crankshafts and of axles, keyways in shafts, screw threads, and rivet holes are examples of locations where high localized stress is liable to occur.

RELATION BETWEEN MICROSCOPIC STRUCTURE AND FATIGUE

A very large field of investigation and one in which very little systematic work has been done is the study by means of the microscope of fatigue failures in various characteristic structures of metals, especially steels. The following paragraphs are given as a summary of the theory held by present-day metallogra-

phists of the relation of microstructure of metal to its fatigue strength. Many of the details of this theory, however, lack adequate experimental verification.

Annealed steel consisting of ferrite (pure iron) and cementite (iron carbide, Fe_3C) seems to increase in resistance to fatigue with the increase in carbon content, especially when the cementite is present in the form of plates as in lamellar pearlite and as long as the cementite does not surround the grains of pearlite. When the cementite is spheroidized, the elastic limit is greatly decreased and probably the resistance to fatigue is also decreased. As a structural material, therefore, a steel with considerable carbon in the form of spherical globules of iron carbide would have practically no advantages over wrought iron. When, however, the iron carbide is in plates it seems to have a marked effect in raising the elastic limit, and probably increases the resistance to fatigue. We would also expect that complete and large networks of ferrite would lower fatigue resistance.

The same arguments regarding grain size of single constituent metals hold to a certain extent for two component alloys. For example, such experimental evidence as is available indicates that the sorbitic structure in steel is the one which resists fatigue best. This structure is supposed to represent an extreme refinement of grain in which the particles of iron carbide are very small, and hence the particles of ferrite must also be very small. It is true that some of the iron carbide may be in solution in the iron, but it is more probable that the mechanical properties observed can be accounted for by an extreme reduction in the size and by the dispersion of ferrite and cementite particles. When these globules are made larger by heating to a higher temperature than that at which the sorbite was formed, granular pearlite results with reduced fatigue resistance.

When a high-carbon steel is quenched from above the critical range to form martensite, the metal becomes extremely brittle. The normal path of static rupture in brittle martensite is at the old austenite (solid solution of Fe_3C in gamma iron) grain boundaries. The path of rupture in fatigue has, so far as is known, not been ascertained. From certain tests on the resistance to fatigue of chrome-vanadium steel after various heat treatments, Dr. C. M. Olmstead, of the C. M. O. Physical Laboratories, Buffalo, found that the steel in the martensitic state, that is, as quenched, had a very much lower resistance to fatigue than after reheating to about 1100 degrees F. The maximum resistance to fatigue occurred by quenching and reheating to 1000-1200 degrees F. (538-648 degrees C.), and there was very little difference between the specimens tempered at 1000 degrees and at 1200 degrees. There was a marked difference, however, between these and the samples tempered at lower temperatures or those not tempered at all. This is the heat treatment that is commonly given to automobile parts which must withstand fatigue stresses, and which may be subjected to shock. The tempering of springs is done at a little lower temperature, but it is not certain that the spring structure is the one having the highest resistance to continued repetition of stresses.

It seems from the above that martensite is not a suitable material to withstand fatigue stresses, and that some intermediate structure between mar-

tensite and the annealed or normalized structure will have the maximum resistance to fatigue. This structure is called the sorbitic structure and corresponds to that used in automobile springs and other parts of automobiles which must resist fatigue and shock stresses.

FORMULÆ FOR DESIGNING PARTS SUBJECTED TO REPEATED STRESS

All formulæ which have been proposed for designing parts subjected to repeated stress depend upon extrapolation from test results and should therefore be regarded as tentative. Their use is justified only on the ground of necessity. Parts must be designed to resist repeated stress, and even formulæ derived from a confessedly inadequate experimental basis seem better than mere guesswork. Two types of formula have been used.^{68(d), 79(b)}

In many discussions of data of repeated-stress tests, it is assumed that there exists some definite "endurance limit," that is, some stress, greater than zero, which can be repeated an infinite number of times without causing failure of the material. If such a limit exists it is certainly lower than the elastic limit of the material as determined by static tests, for actual failures of materials have occurred under repeated nominal stresses as low as one-quarter of the elastic limit as determined by a static test. Examination of test data indicates that the endurance limit is an assumption rather than a proved fact. It is usually determined by plotting a diagram with stresses as ordinates and number of repetitions producing failure as abscissas and estimating the stress for which the diagram seems to become horizontal. Various other methods have been proposed, but all involve this assumption.⁸³

In 1910 a paper⁸ presented before the American Society for Testing Materials pointed out that an examination of the results of numerous series of repeated-stress tests indicates that for nearly all the range covered the law of resistance to repeated stress may be expressed by the equation:

$$S = KN^{-m} \dots\dots\dots [1]$$

in which S is the maximum unit stress developed in the test piece, N the number of repetitions of stress necessary to cause failure, and K and m are constants depending on the material and somewhat on the manner of making the test. This is known as the "exponential equation for repeated stress."

Another form of expression for the above equation, and frequently more convenient, is:

$$\log S = \log K - m \log N \dots\dots\dots [2]$$

If the logarithms of S and N are plotted, or if the values of S and N are plotted on logarithmic cross-section paper, Equation [2] is represented by a straight line. Fig. 36 shows the S - N diagram given by a series of repeated-stress tests. In Fig. 36(a) ordinary coördinates are used, but in Fig. 36(c) the coördinates are logarithmic. For large values of N the exponential equation, which is represented by the inclined line of the diagram, would give values of S smaller than the observed values; in other words, the exponential formula seems to err on the side of safety.

It will be noted that the use of the exponential formula involves the assumption that any stress if repeated often enough will eventually produce failure of the material. Thus while both the endurance limit and the exponential formula are based on extrapolation from known data, the exponential formula seems to be an assumption on the safe side. The working stresses as developed by the two methods do not differ greatly except for members subject to more than ten million repetitions of stress. Above that number the exponential formula requires lower working stress, but even then the stresses given by the exponential formula are not impracticably low.

While nothing but tentative formulæ can be proposed now,³⁰ some features which a satisfactory formula for fatigue strength should include may be noted. It is probable that such a formula for any material will not depend on ordinary static qualities of the material such as elastic limit or tensile strength. It may depend on some form of elastic limit determined after the material has been put in a "cyclic" or "normalized" state by a number of reversals of stress. Such a formula will quite probably contain factors dependent on the surface finish of the part and upon the uniformity and regularity of its crystalline structure. It will contain a factor dependent on the range of stress during a cycle. Such a formula may contain a factor dependent on the probable number of repetitions of stress which the part may be expected to withstand during a normal period of service, or the result may be an "endurance limit"—a stress which the part is capable of withstanding so many times that even for modern high-speed machinery the number of repetitions may be regarded as infinite.

APPENDIX C

GLOSSARY OF TECHNICAL TERMS

- ALLOY STEEL . . . A steel which owes its characteristic properties chiefly to the presence of an element or elements other than carbon. In the present investigation the two alloy steels tested were nickel steel and chrome-nickel steel.
- ANNEALING . . . See Heat Treatment.
- AUSTENITE . . . See Metallography.
- BENDING MOMENT . . . A moment is equivalent to the product of a force multiplied by a distance, and is measured in inch-pounds or in foot-pounds. The bending moment at any cross-section of a piece under flexure measures the tendency to cause flexural failure, and is equal in magnitude to the summation of the moments of the forces on one side of the cross-section.
- BRINNEL TEST . . . See Hardness.
- CEMENTITE . . . See Metallography.
- CHARPY TEST . . . See Impact Test.
- COLD BENDING . . . See Cold Working.
- COLD-DRAWN STEEL . . . See Cold Working.
- COLD JUNCTION . . . See Pyrometer.
- COLD-ROLLED STEEL . . . See Cold Working.
- COLD STRETCHING . . . See Cold Working.
- COLD WORKING . . . Changing the shape of steel parts by compressing, stretching, bending, or twisting, using stresses beyond the yield point and temperatures below the critical range. Cold-drawn steel is finished by being drawn through a die, while cold-rolled steel is finished between rollers.
- COMPRESSION . . . See Deformation.
- CONSTANTAN . . . An alloy of copper and nickel used in thermo-couples.
- CRITICAL RANGE . . . See Metallography.
- CRYSTAL . . . See Metallography.
- CYCLE OF STRESS . . . See Repeated Stress.
- DEFORMATION . . . Change of form of a member accompanying the application of external load. The term strain is used in this bulletin as synonymous with deformation. Deformations may be stretches under tension, compressions under compressive load, deflections under bending (or flexure), twists under torsional moment, or detrusions under shear. Twist is a special case of shearing detrusion. The deformation per unit of length over any gage length on a specimen is called the unit deformation or unit strain.

- DETRUSION See Deformation.
- DRAWING See Heat Treatment.
- DUCTILITY Ability to withstand stretch without rupture. Ductility is usually measured by the percentage of elongation after rupture over a gage length laid off on a specimen before stretching, or by the reduction of area of the original cross-section of a specimen when tested in tension.
- ELASTIC LIMIT . . . The term "elastic limit" is, unfortunately, used very loosely in general practice. In this bulletin the term elastic limit or set elastic limit is used to denote the highest unit stress at which material will completely recover its form after the stress is removed. Proportional limit, or proportional elastic limit, is used to denote the highest unit stress at which stress is proportional to deformation. The values found for both elastic limit and proportional limit are dependent on the accuracy of apparatus used and the precision of plotting stress-strain diagrams. For practical purposes elastic limit and proportional limit may be regarded as interchangeable terms. The yield point is that unit stress at which material shows a sudden marked increase in the rate of deformation without increase in load. It is usually determined by the sudden drop in the balance beam of the testing machine as strain is applied to the specimen at a uniform rate, or by a sudden increase of deformation which can be seen by the use of a pair of dividers on the specimen. The "FR" point referred to in this bulletin is a special limit determined by very delicate flexure tests. The method of determining it is described in the reference given in connection with the text.
- ELONGATION See Ductility.
- ENDURANCE In this bulletin the term endurance is used to denote the number of cycles of repeated stress withstood by a specimen before failure.
- ENDURANCE LIMIT . . The highest unit stress which, applied in cycles of completely reversed stress, can be withstood an indefinite number of times without failure. If an *S-N* diagram for a series of reversed-stress tests is plotted to logarithmic coördinates the endurance limit is the unit stress at which the diagram abruptly changes direction from a sloping line to a horizontal line.
- ENDURANCE STRENGTH . . . A general term denoting ability to resist repeated stress; synonymous with fatigue strength.
- EXTENSOMETER . . . An instrument for measuring small changes of length of specimens under tension. Sometimes the term is loosely

- used to denote any instrument for measuring small deformations of material.
- FATIGUE The action which takes place in material causing failure after a large number of applications of stress. Failures due to fatigue are characterized by their suddenness, and by the absence of general deformation in the piece which fails.
- FATIGUE LIMIT . . See Endurance Limit.
- FATIGUE STRENGTH. See Endurance Strength.
- FERRITE See Metallography.
- FERROUS METALS . Metals whose principal ingredient is iron. The common ferrous metals are: wrought iron, cast iron, malleable cast iron, and steel.
- FILLET A curved surface at the junction of two different sized parts of a machine member. The use of a fillet prevents a sharp shoulder at the junction.
- FLAW In this bulletin this term is used to denote any defect in metal, either a surface defect or a defect in grain structure.
- FLEXURE See Deformation.
- “FR” POINT. . . See Elastic Limit.
- GRAIN See Metallography.
- HARDNESS The term hardness is used with a variety of meanings. In this bulletin it is used to denote resistance to penetration. The two common tests for hardness are the Brinell test and the scleroscope test. In the Brinell test a hardened steel ball of a standard diameter is forced against the surface of a test specimen, using a standard pressure. The diameter or the depth of the resulting impression is an inverse measure of the hardness. In the scleroscope test a small weight fitted with a diamond point is allowed to fall from a standard height upon the surface of the specimen, thus causing a minute indentation. The height of rebound is a measure of the hardness.
- HEAT TREATMENT . Heat treatment of steel is the proper control of heating and cooling so as to produce the desired structure (pearlitic, sorbitic, etc.), and includes:
- ANNEALING, which consists in very slow cooling from above the critical range, and which gives a large-grained, soft, pearlitic structure;
- NORMALIZING, which consists in cooling from above the critical range in still air, and which gives a fine-grained, pearlitic structure;
- OIL QUENCHING, which consists in cooling from above the critical range by cooling in oil at room temperature, and which yields steel of sorbitic or troostitic structure, depending

on the carbon content (certain special alloy steels yield a martensitic structure or even an austenitic structure with oil quenching);

WATER QUENCHING, which consists in cooling from above the critical range by cooling in water at room temperature, and which yields steel of martensitic, troostitic, or sorbitic structure, depending on the carbon content (certain special alloy steels yield a martensitic or an austenitic structure with water quenching);

DRAWING, which consists in reheating quenched steel to a temperature slightly below the critical range and then cooling. This process tends to bring martensitic, troostitic, or sorbitic steel towards the pearlitic state, and, by varying the temperature of drawing, it is possible to control the state of the steel with a good degree of precision.

Other liquids are sometimes used for quenching steel; such as molten lead, molten barium chloride, ice water, and brine.

Alloying elements, including carbon, slow up the transition period so that high-carbon steels and alloy steels are more susceptible to heat treatment than are low-carbon steels. See Metallography.

HYSTERESIS, MECHANICAL . . . If load is applied to a specimen, and is removed, then, if the specimen is perfectly elastic under the stress caused by the load, the energy expended in loading the specimen is all given back when the load is removed. If the specimen is not perfectly elastic under the stress caused by the applied load, then some of the energy applied is dissipated as heat. This dissipated energy is called mechanical hysteresis, and is measured by the area of the loop between the stress-strain diagram for application of load and the stress-strain diagram for release of load.

IMPACT TEST . . . A test in which a specimen is subjected to a very suddenly applied load. In the machines commonly used for making impact tests of steel specimens the sudden load is applied by the blow of a swinging pendulum. The three testing machines in common use for this test are the Charpy, the Izod, and the Olsen. Impact tests in flexure are usually made on small beams of steel with a sharp notch in them, because an unnotched beam would bend without fracturing; such tests being sometimes called notched-bar tests. Impact-tension tests are also sometimes made. In the three machines mentioned above enough energy is stored in the raised pendulum to break the specimen with a single blow. Impact tests using repeated blows

- to fracture the specimen are also made. A well known machine for making such tests is the Stanton machine.
- IRON For the distinction between iron and steel, see Steel.
- IZOD TEST See Impact Test.
- LOGARITHMIC COÖRDINATES Coördinates for plotting results of tests in which the scale used is proportional to the logarithms of the values plotted. Logarithmic coördinates have been found useful in plotting the results of repeated-stress tests.
- MARTENSITE See Metallography.
- MARTENSITIC See Metallography.
- METALLOGRAPHY Metallography deals with the physical state and the proximate constituents of a metal or an alloy. It has to do with the physical grouping, distribution of constituents, and relative dimensions of the substances as revealed by microscopic examination. It may be characterized as a study of the anatomy of metals.

Steel is an alloy the essential constituents of which are iron and carbon, the latter being the controlling element. The carbon exists in steel as a carbide of iron, Fe_3C , to which the name cementite is applied. The free iron or ferrite, together with the cementite, has the power of forming a conglomerate called pearlite, a very intimate mechanical mixture composed of about 7 parts of ferrite to one part of cementite. If molten iron is cooled there is formed first a solution of carbon in molten iron, then as the metal solidifies the carbon exists as cementite in solid solution in the iron. This solid solution is called austenite, and it crystallizes into imperfect crystals or grains. With further cooling the steel passes through a critical or transformation range of temperature (extreme range about 1650 degrees F. to 1250 degrees F.), and the two constituents of the metal pass successively through several transition stages, namely: martensite, in which long needle-like crystals are formed, giving a very hard and brittle substance; troostite, in which dark colored masses resembling sorbite (see below) are surrounded by a groundwork of martensite, the troostitic state yielding a substance hard but tougher than the martensitic; sorbite, in which cementite and ferrite are in a state resembling an emulsion, yielding a substance fairly hard and very tough; and pearlite, in which ferrite and cementite exist, usually in stratified layers or bands. If the steel has a carbon content of about 0.90 per cent all the grains will be pearlite; if the carbon content is lower than 0.90 per cent there will be grains of pearlite and grains of ferrite; if the carbon

content is greater than about 0.90 per cent there will be grains of pearlite and grains of cementite.

The presence of carbon or of other alloying elements slows down the process of transition. By varying the rate of quenching steel the transition process may in general be halted at any desired stage, and the resulting cooled steel may be given any desired characteristic structure. See Heat Treatment, Micrograph.

- MICROGRAPH . . . Micrographs are obtained by polishing the surface of a metal, etching the polished surface with a suitable reagent to bring out the metallographic structure, then reproducing, usually by photographic methods, the appearance of the surface as seen through a microscope. Photomicrograph and microphotograph are terms sometimes used for micrographs made by a photographic process.
- MILLIVOLTMETER . . . An electrical instrument for measuring small electric potentials. Used for measuring the small voltages of thermocouples developed by changes of temperature.
- NON-FERROUS METALS . . . Metals in which iron is not a constituent, or is only present in very small quantities.
- OVERSTRESS . . . Stress above any given limit of safety, used in this bulletin in general, to denote stress above the endurance limit.
- PEARLITE See Metallography.
- PEARLITIC See Metallography.
- PYROMETER An instrument for measuring high temperatures. In this investigation the pyrometers used were of the thermoelectric type, which utilizes the electromotive force generated by a junction of two dissimilar metals when exposed to heat. In each pyrometer there were two junctions each made by welding together wires of the two dissimilar metals, platinum and platinum-rhodium for example. One junction is then exposed to the temperature to be measured and is called the hot junction; the other junction, which is opposed to the first-named junction, is kept at a constant temperature and is called the cold junction. A millivoltmeter, or other instrument for measuring electromotive force, is attached by conductors to the free ends of the opposed junctions, and by its reading indicates the electromotive force generated and hence the temperature of the hot junction.
- RANGE OF STRESS . . . See Repeated Stress.
- REPEATED STRESS . . . This is the general term used to denote any regular variation of stress applied to a member a large number of times. Repeated stress includes variations in magnitude of stress in one direction, variations from stress in one

direction to a smaller stress in the opposite direction, and variations from stress in one direction to equal stress in the opposite direction. This last-named case of repeated stress is called reversed or alternating stress. In repeated stress the periods of variation are repeated again and again, and each complete period of variation is called a cycle of stress. The algebraic difference between the maximum stress and the minimum stress during a cycle of stress is called the range of stress.

- SHEAR, SHEARING STRESS . . . See Stress.
- SLIP BANDS, SLIP LINES . . . Minute cracks which, under the action of destructive repeated stress, form within the crystals of metal. See Fig. 46.
- S-N DIAGRAM. . . A diagram showing the results of a series of repeated-stress tests. Values of unit stress are plotted as ordinates, and values of corresponding numbers of cycles of stress to cause failure are plotted as abscissas. In this bulletin logarithmic coördinates have been used for plotting *S-N* diagrams.
- SORBITE. . . . See Metallography.
- SORBITIC See Metallography.
- STATIC TEST . . . A test of a specimen in which the rate of application of load is so slow that it may be regarded as zero. The term refers in general to a test made with an ordinary testing machine.
- STEEL The term steel is used to denote any ferrous metal with a carbon content less than about 1.7 per cent, which is made by a process involving complete fusion. Thus in this bulletin Steel No. 9, which chemically is almost pure iron, and which is called Armeo Iron by the manufacturers, is designated as 0.02 carbon steel. Wrought iron has a low carbon content, and is made from a pasty mass at a temperature below complete fusion. Ferrous metals with a carbon content higher than about 1.7 per cent are called cast iron.
- STRESS An internal force which resists the destructive action of external force. Stresses are always accompanied by strains or deformations, and there are tensile stresses, compressive stresses, and shearing stresses. Torsion on a specimen is resisted by shearing stress. At any point on a stressed member the stress per unit area is called the unit stress. Sometimes the term stress is used to denote unit stress.
- TESTING MACHINE . In general, any machine for applying stress to specimens of material, and measuring the applied stress. The term

is ordinarily applied to a machine for applying stress at a slow rate and measuring the stress by means of a weighing scale.

- TOUGHNESS In this bulletin the term toughness is used to denote a combination of strength and ductility in a material.
- TROOSTITE See Metallography.
- TROOSTITIC. . . . See Metallography.
- TWISTING MOMENT. The twisting moment on any cross-section of a member in torsion is equal to the sum of the twisting moments of the forces acting on one side of the cross-section. See Bending Moment.
- ULTIMATE TENSILE STRENGTH . . . The highest unit stress carried by a tension specimen in a test to rupture. In computing ultimate tensile strength the original area of cross-section of the specimen is used.

APPENDIX D

BIBLIOGRAPHY

OF BOOKS, MONOGRAPHS, AND ARTICLES IN PERIODICALS DEALING WITH THE FATIGUE OF METALS AND RELATED PHENOMENA

1. ANDREWS, T. "Microscopic Internal Flaws Inducing Fracture in Steel." Engineering, London, July, 1896.
2. ARNOLD, J. O. (a) "Dangerous Crystallization of Mild Steel and Wrought Iron." (Description of Main Features of Arnold's Alternate Bending Machine.) Inst. C. E. Proc., 154. (Supplement, 1903.)
(b) "Fracture of Structural Steel Under Alternating Stress." Brit. Assoc. Report, 1904. Sci. Abs., 1904, Nos. 1929b, 2795b.
(c) "Factors of Safety in Marine Engineering." Trans. Inst. of Naval Arch., Vol. L, p. 260, 1908. Engineering, London, Apr. 24, 1908, p. 565.
(d) "Ghost Lines in Steel Forgings." Inst. of Mech. Eng., 1915. Engineering, London, Nov. 26, 1915.
3. ARNOLD, J. O. and READ, A. A. (a) "The Chemical and Mechanical Relations of Iron, Tungsten, and Carbon, and of Iron, Nickel, and Carbon." Engineering, London, March 27, 1914. Inst. of Mech. Eng., 1914.
(b) "The Chemical and Mechanical Relations of Iron, Cobalt, and Carbon." Engineering, London, March 27, 1915.
(c) "The Chemical and Mechanical Relations of Iron, Molybdenum, and Carbon." Engineering, London, Nov. 26, 1915. Inst. Mech. Eng., 1915.
4. BAILEY, R. W. "Ductile Materials Under Variable Shear Stress." Engineering, London, July 27, 1917, p. 81.
5. BAIRSTOW, L. "The Elastic Limits of Iron and Steel Under Cyclical Variations of Stress." Phil. Trans. Roy. Soc., Vol. A, 210, p. 35, 1910.
6. BAKER, SIR B. "Some Notes on the Working Stress of Iron and Steel." Trans. Am. Soc. Mech. Eng., Vol. 8, p. 157, 1886. See Unwin's "Testing of Materials."
7. BAKER, F. "Report of Tests of Metals." Abs. in Iron and Steel Inst. Jour., 1905, II, p. 768.
8. BASQUIN, O. H. "The Exponential Law of Endurance Tests." Proc. Am. Soc. for Test. Mat., Vol. X, p. 625, 1910.
9. BAUSCHINGER, J. (a) "Die Veränderung der Elasticitätsgrenze und des Elasticitätsmoduls verschiedener Metalle"; Mitthlg. des Mechanisch-Technischen Laboratoriums der kgl. Techn. Hochschule. München, Heft 13; also, Dingler's Journal, Bd. 224, and Civilingenieur for 1881.

- (b) "Über die Veränderung der Elasticitätsgrenze und Festigkeit des Eisens," etc. Mitthlg. aus dem Mechanischtechnischen Laboratorium in München, 1886. (See Unwin's "Testing of Materials," also, for Bauschinger's earlier paper.)
10. BEILBY, G. T. "The Hard and Soft States in Metals." *Jour. of the Inst. of Met.*, 1911, No. 2, p. 5.
 11. BENGOUGH, G. D. "A Study of the Properties of Alloys at High Temperatures." *Jour. of the Inst. of Met.*, No. 1, 1912, p. 123.
 12. BERGER, KARL "Elasticity of Cast Iron Subjected to Repeated Tensile and Compressive Strain." See Abs. in *Proc. Inst. Civ. Eng.*, cxxvii, 370.
 13. BERLINER, S. "Behaviour of Cast Iron Under Slowly Alternating Stress." *Ann. de Physique*, 20, 3, June, 1906. *Sci. Abs.*, 1906, No. 1528.
 14. BLOUNT, B.; KIRKALDY, W. G.; SANKEY, H. R. "Tensile, Impact Tensile, and Repeated Bending Tests of Steel." *Inst. Mech. Eng. Proc.*, 2, 1910. *Sci. Abs. A*, 300, 1911.
 15. BOUDOUARD, O. (a) "Tests on Metals by Study of the Damping of Vibrations." *Comptes Rendus*, 150, March 14, 1910. *Sci. Abs.*, 1910, No. 645.
(b) "Tests of Metals by the Abatement of Vibrating Movements." *Comptes Rendus*, 152, Jan. 3, 1911. *Sci. Abs.*, 1911, No. 295.
(c) "Breakdown Tests of Metals." (Alternate Bending.) *Int. Assoc. for Test. Mat.*, Paper V 3, 1912.
 16. BOUASSE, H. and BERTHIER, "Decay of Oscillations." *Ann. Chem. Phys.*, 10, Feb., 1907. *Sci. Abs. A*, 1907, No. 710.
 17. BOUASSE, H. and CARRIERE, L. "Decay of Oscillations." *Sci. Abs.*, 1908, No. 1225. *Ann. Chem. Phys.* 14, June, 1908; also *Ann. Chem. Phys.* 2, May, 1904.
 18. BURR, W. H. "The Elasticity and Resistance of Materials of Engineering." 1915, p. 795.
 19. BURROWS, C. W. "Some Applications of Magnetic Analysis to the Study of Steel Products." *Proc. Am. Soc. for Test. Mat.*, Vol. XVII, Pt. II, p. 88, and especially p. 109, 1914. Also Bureau of Standards, Scientific Paper No. 272.
 20. CAPP and LAWSON, "Thermoelectric Indication of Strain as a Testing Method." *Int. Assoc. for Test. Mat.*, 1912, Art. IX.
 21. COKER, E. G. (a) "Endurance of Steel Bars Subjected to Repetitions of Tensional Stress." *Proc. Inst. Civ. Eng.*, cxxxv, p. 294.
(b) "Effect of Low Temperature on Over-Strained Iron and Steel." *Phys. Revs.*, August 15, 1902. *Sci. Abs.*, 1903, No. 227. See also E. J. McCaustland.
(c) *Brit. Assoc. Report*, 1910. *Engineering*, London, Sept. 16, 1910, p. 412.
(d) "Photo-Elasticity." *Engineering*, London, Jan. 6, 1911, p. 1.

- (e) "The Determination, by Photo-Elastic Methods, of the Distribution of Stress in Plates of Variable Sections with Some Application to Ships' Plating." *Inst. Naval Arch.*, 1911. *Engineering*, London, Apr. 21, 1911, p. 514.
- (f) "The Optical Determination of Stress." *Phil. Mag.*, Oct., 1910.
- (g) "Optical Determination of Stress, and Some Applications to Engineering Problems." *Engineering*, London, March 8, 1912, p. 325.
- (h) "The Distribution of Stress at the Minimum Section of a Cement Briquette." *Int. Assoc. Test. Mat.*, 1912. *Engineering*, London, Dec. 13, 1912, p. 824.
- (i) "Stress Distribution in Materials." *Brit. Assoc. Report*, 1914. *Engineering*, London, Aug. 21, 1914.
- (j) "The Effects of Holes, Cracks, and Other Discontinuities in Ships' Plating." *Inst. Naval Arch.*, March 25, 1920. *Engineering*, London, June 18, 1920.
- (k) "Tension Tests of Materials." *Engineering*, London, Jan. 7, 1921.
22. COKER, E. G. and SCOBLE, W. A. "The Distribution of Stress Due to a Rivet in a Plate." *Inst. of Naval Arch.*, March 14, 1913. *Engineering*, London, March 28, 1913, p. 439.
23. CORSE and COMSTOCK, "Aluminum Bronze, Some Recent Tests and Their Significance." *Proc. Am. Soc. for Test. Mat.*, Vol. XVI, Pt. II, p. 118, with discussion following.
24. DALBY, W. E. "Researches on the Elastic Properties and the Plastic Extension of Metals." *Phil. Trans. Roy. Soc.*, Vol. 221 A, 1920.
25. DRAGO, E. (a) "Influence of Oscillatory Discharge on Decay of Torsional Oscillations." *Acead. Lincei, Atti* 20, pp. 100-107. *Sci. Abs. A*, 1911, 1423.
- (b) "Influence of Oscillatory Discharge on Decay of Torsional Oscillations." *Acead. Lincei, Atti* 20, pp. 369-376. *Sci. Abs. A*, 1912, 2.
26. DUDLEY, C. B. "Alternate Bending Stresses." *Iron and Steel Magazine*, Feb., 1904, p. 134.
27. EDEN, E. M. "Endurance of Metal Under Alternating Stress and Effect of Rate of Alternation on Endurance." *Univ. of Durham, Phil. Soc. Proc.*, 3, 5, 1910. *Sci. Abs.*, 1910, No. 1384.
28. EDEN, ROSE, and CUNNINGHAM, "The Endurance of Metals." *Proc. Inst. of Mech. Eng. (Brit.)*, p. 839, Pts. 3 and 4, 1911.
29. ERCOLINI, G. (a) "Effect of Deformation Upon Torsional Couple Exerted by a Twisted Wire." *Acead. Lincei, Atti* 15, Sept. 2, 1906. *Sci. Abs.*, 1906, No. 1807.
- (b) "Recent Experiments on Elasticity." *Sci. Abs.*, 1909, No. 965.
30. EWING and ROSENHAIN, "Crystalling Structure of Metals." *Phil. Trans. Roy. Soc.*, Vol. 193, p. 352, 1899.

31. EWING, SIR J. A. "On Hysteresis in the Relation of Strain to Stress." Brit. Assoc. Report, 1899, p. 502. See also Ewing's "Strength of Materials."
32. EWING, SIR J. A. and HUMPHREY, J. C. W. "Fracture of Metals Under Repeated Alternations of Stress." Phil. Trans. Roy. Soc. A, 200, p. 241, 1903.
33. FAIRBAIRN, SIR W. "The Effect of Impact Vibratory Action and Changes of Load on Wrought-Iron Girders." Phil. Trans. Roy. Soc., 1864. See Unwin's "Testing of Materials."
34. FINLEY, W. H. "Case of Failure of Iron from Fatigue." Engineering News, 1906, 55, p. 487. Sci. Abs. A, 1200, 1906.
35. FOSTER, F. "Repetition of Stress." Mech. Eng., Nov. 22, 1902. Sci. Abs., 1903, No. 866.
36. FREMONT, C. (a) "The Fatigue of Metals and New Methods of Testing." Genie Civil, Oct. 22, 1910.
(b) Continuation of above, Genie Civil, Nov. 19, 1910.
37. FULTON, A. R. "Experiments on the Effect of Alternations of Tensile Stress at Low Frequencies on the Elastic Properties of Mild Steel." Brit. Assoc. Report, 1920. Engineering, London, Jan. 9, 1920, p. 65.
38. GARDNER, J. C. "Effects Caused by the Reversal of Stresses in Steel." Jour. Iron and Steel Inst., No. 1, p. 481, 1905. Sci. Abs., 1905, No. 1804.
39. GIBSON, W. A. "Fatigue and Impact Tests of Aluminum Alloys." Proc. Am. Soc. for Test. Mat., Vol. xx, Pt. II, p. 115, 1920.
40. GILCHRIST, J. "Wöhler's Theories on Material Under Repeated Stress." The Engineer, London, Vol. 90, p. 203, 1900.
41. GRAMMEL, DR. R. "Neuere Versuche über Elastische Hysterese." Zeit. Ver. Deut. Ing., Vol. 58, Nov. 28, 1914. Jour. A. S. M. E., Feb., 1915.
42. GRIMALDI, G. and ACCOLLA, G. "Influence of Magnetisation upon the Elastic Hysteresis for Extension of Iron." See Sci. Abs. A, 1905, 927.
43. GRIMALDI, G. and ACCOLLA, G. "Influence of Oscillatory Discharge and Magnetisation upon the Elastic Hysteresis for Extension of Iron." *Elettricista*, Rome, 8, pp. 329-31. *N. Cimento*, '18, pp. 446-477. Sci. Abs., 1910, No. 376.
44. GUEST and LEA, "Torsional Hysteresis of Mild Steel." Proc. Roy. Soc. of London, Series A, Vol. 93, p. 313, 1916-17.
45. GULLIVER, "Internal Friction in Loaded Materials." Int. Assoc. for Test. Mat., 5th Congress, Art. VIII, 1909.
46. GUYE, C. E. "Internal Friction of Solids, Variation with Temperature." Jour. de Physique, 2 Ser. 5, Aug., 1912. Sci. Abs., A, 1912, 1793.
47. GUYE and FREDERICKSZ, (a) "Internal Friction of Solids at Low Temperatures." (Decrement of Torsional Oscillations.) Comptes Rendus, 149, Dec. 6, 1909. Sci. Abs., 1910, No. 224. Comptes Rendus, 150, Apr. 18, 1910. Sci. Abs., 1910, No. 1189.

- (b) "Description of Krupp's Laboratory." (Mention battery of six alternating-shock bending machines.) *Revue de Metallurgie*, 9, Sept., 1912.
48. GUYE and MINTZ, "On Internal Friction of Solids at Low Temperatures." *Archives des Sciences*, 26, pp. 136 and 263, 1908.
49. HAIGH, B. P. (a) "Alternating Load Tests." *Brit. Assoc.*, 1912. *Engineering*, London, Nov. 22, 1912. *Sci. Abs.*, 1912, No. 1612.
 (b) Report of Com. on Stress Distribution in Eng. Materials, *Brit. Assoc.*, 1915, p. 163.
 (c) "The Fatigue of Brass." *Engineering*, London, Sept. 21, 1917, p. 218. *Inst. of Metals*, Sept. 19, 1917.
50. HANCOCK, E. L. (a) "Tests of Metals in Reversed Torsion." *Am. Soc. Test. Mat.*, 1906, p. 308. *Phil. Mag.*, 1906, 12, pp. 426-430. *Ind. Eng. Soc.*, 1907, p. 157.
51. HATFIELD, W. T. "Mechanical Properties of Steel." *Engineering*, London, May 9, 1919. *Inst. of Mech. Eng.*, May, 1919.
52. HAUGHTON, S. A. "Failure of an Iron Plate Through Fatigue." *Sci. Abs. A*, 1905, 1846. *Jour. Iron and Steel Inst. Proc.*, 1905.
53. HOPKINSON, B. (a) "Effects of Momentary Stresses in Metals." *Roy. Soc.*, Vol. 74, p. 498, 1905.
 (b) "A High-Speed Fatigue Tester and the Endurance of Metals Under Alternating Stress of High Frequency." *Proc. Roy. Soc., A*, 86, Jan. 31, 1912. *Sci. Abs.*, 1912, No. 628.
54. HOPKINSON, B. and ROGERS, F. "Elastic Properties of Steel at High Temperatures." *Proc. Roy. Soc., A*, 76, 1905.
55. HOPKINSON, B., and WILLIAMS, G. T. "The Elastic Hysteresis of Steel." *Proc. Roy. Soc.*, Nov. 21, 1912, A-87.
56. HOWARD, J. E. (a) "Watertown Arsenal Reports." 1888, 1893. See *Mass. Inst. of Tech., Quart. Proc.*, 1899.
 (b) "Alternate Stress Testing and Heat Treatment of Steels." *Engineering Record*, Sept. 22, 1906. *Int. Assoc. Test. Mat.*, Congress, 1906. *Sci. Abs.*, 1906, No. 1808.
 (c) "Notes on the Endurance of Steels Under Repeated Alterations of Stress." *Proc. Am. Soc. for Test. Mat.*, Vol. VII, p. 252, 1907; compiled from "Tests of Metals," *Watertown Arsenal Reports*, 1898-1910.
 (d) "Resistance of Steels to Repeated Alternate Stresses." Paper read *Int. Assoc. Test. Mat.*, 1909. See also *Mech. Eng.*, 24, Dec. 31, 1909. *Sci. Abs.*, 1910, No. 218.
57. HOWE, H. M. (a) "Are the Effects of Simple Overstrain Monotropic?" *Proc. Am. Soc. for Test. Mat.*, Vol. XIV, p. 7, 1914.
 (b) "The Metallography of Steel and Cast Iron." N. Y., 1916. So much of the book applies to the amorphous theory and plastic deformation that specific references need not be given.

58. HUMFREY, J. C. W. "Influence of Intercrystalline Cohesion of the Mechanical Properties of Metals." Iron and Steel Inst., Carnegie Scholarship Memoirs, 1913, p. 5, 86-99.
59. HUNTINGTON, A. F. "The Effects of Heat and Work on the Mechanical Properties of Metals." Inst. of Metals, 1915, Engineering, London, March 19, 1915.
60. HYDE, J. H. "Resistance of Tension Members to Lateral Vibrations." Engineering, London, June 23, 1916, p. 605.
61. INGLIS, C. E. "Stresses in a Plate Due to the Presence of Cracks and Sharp Corners." Trans. Inst. of Naval Arch. (Brit.), Vol. LV, Pt. I, p. 219, 1913.
62. JEFFRIES, ZAY. "The Amorphous Metal Hypothesis and Equi-Cohesive Temperatures." Bul., Am. Inst. of Metals, Dec., 1917, pp. 300-324.
63. JEFFRIES, ZAY and ARCHER, R. S. "The Slip Interference Theory of the Hardening of Metals." Chem. and Met. Eng., Vol. 24, No. 24, p. 1057, June 15, 1921.
64. JENKINS, C. F. "The Strength and Suitability of Engineering Materials." Brit. Assoc. Report, 1920. Engineering, London, Aug. 27, 1920, p. 290.
65. JONSON, E. "Fatigue of Copper Alloys." Proc. Am. Soc. Test. Mat., 1915, p. 101.
66. KAPP, G. "Alternating Stress Machine." Zeit. Ver. Deut. Ing., Aug. 26, 1911.
67. KELVIN, LORD. (a) "On the Elasticity and Viscosity of Metals." Proc. Roy. Soc., May 18, 1865; also "Collected Mathematical and Physical Papers." Vol. III.
(b) Article Elasticity, Ency. Brit., Vol. VII, 9th Ed.
68. KOMMERS, J. B. (a) "Repeated Stress Tests of Steel." Am. Mach., Apr. 1, 1915, p. 551.
(b) "Repeated Stress Testing." Proc. Int. Assoc. for Test. Mat., Arts. V4a and V4b, 1912. Sci. Abs. A, 1912, 1794.
(c) "Broader Use of Johnson's Formula for Repeated Stress." Engineering News-Record, Vol. LXXXIII, No. 20, p. 942, Nov. 27, 1919.
(d) "The Fatigue of Metals." Chap. XXVIII, 5th Ed, Johnson's "Materials of Construction," N. Y., 1919.
(e) "Repeated Stress Safety Factors Quickly Determined." Engineering News-Record, Aug. 26, 1920, p. 393.
69. LAKE, (a) "Titanium as Used in Steel Making." Met. and Chem. Eng., Vol. 2, p. 144, 1913.
(b) "Laudgraf-Turner Alternating Impact Machine." Iron and Steel Times, June 24, 1909. See J. B. Kommers.
70. LENOBLE, E. "Permanent Deformation of Metallic Wire." Hysteresis Loop, Jour. de Physique, 9, Oct., 1900. Sci. Abs., 1901, No. 7.
71. LEON, A. "Fatigue of Machine Parts." Zeit. Ver. Deut. Ing., March 3 and 10, 1917. Summarized in Jour. A. S. M. E., Oct., 1917.

72. LILLY, W. E. (a) "A New Torsion-Testing Machine." Proc. Inst. C. E. of Ireland, Nov. 2, 1910.
(b) "The Elastic Limits and Strength of Materials." Proc. Inst. C. E. of Ireland, Dec. 6, 1911.
73. MARTENS, A. (a) "Fatigue Bending Tests Made Between 1892 and 1912 in the Materialprüfungsamt in Berlin-Lichterfelde." Kgl. Materialprüfungsamt, 1914. Sci. Abs., 1914, No. 1371.
(b) "Handbook of Testing Materials." 1899, p. 257.
74. MASON, W. (a) "Speed Effect and Recovery and Slow Speed Alternating Stress Tests." Proc. Roy. Soc., Vol. 92A, p. 373, 1915-16.
(b) "The Hysteresis of Mild Steel Under Repeated Torsion." Brit. Assoc. Report, 1916. Engineering, London, Sept. 15, 1916.
(c) "Alternating Stress Experiments." Inst. of Mech. Eng., 1917. Engineering, London, Feb. 23, 1917, and succeeding issues.
75. MEMMLER, J. and SCHOB, A. (a) "Temperature Measurements During Repetition of Stress; Experiments With Pipes." Kgl. Materialprüfungsamt, Mitt., 28, 6, pp. 307-333. Sci. Abs. A, 1910, No. 1382.
76. MERICA and KARR, "Some Tests of Light Aluminum Casting Alloys"; "The Effect of Heat Treatment." Am. Soc. for Test. Mat., 1919, II, p. 297.
77. MERICA, WALTEMBERG, and MCCABE, "Some Mechanical Properties of Hot-Rolled Monel Metal." Proc. Am. Soc. for Test. Mat., Vol. XXI, 1921.
78. MILTON, J. T. "Fractures in Large Steel Boiler Plates." Inst. of Naval Arch., July, 1905. Also Engineering, London, Aug. 4 and 11, 1905.
79. MOORE, H. F. (a) "The Physical Significance of the Elastic Limit." Proc. Int. Assoc. for Test. Mat., Art. XXVIII, 1910.
(b) "Text-Book of the Materials of Engineering." 2d Ed., Chap. III.
80. MOORE, H. F. and GEHRIG, A. G. "Some Tests on Nickel Steel and Chrome-Nickel Steel." Proc. Am. Soc. for Test. Mat., Vol. XIX, Pt. II, p. 206, 1919, with discussion by Dix, Ruder, and R. R. Abbott.
81. MOORE, H. F. and KOMMERS, J. B. "Fatigue of Metals Under Repeated Stress." Am. Iron and Steel Inst., 1920, p. 89.
82. MOORE and PUTNAM, Bul. 146, Am. Inst. of Mining and Met. Eng., p. 401, Feb., 1919.
83. MOORE and SEELY, "The Failure of Materials Under Repeated Stress." Proc. Am. Soc. Test. Mat., Vol. XV, Pt. II, p. 438, 1915. See also Proc. Am. Soc. Test. Mat., Vol. XVI, Pt. II, p. 471, 1916, in which a numerical error in the 1915 paper is corrected.
84. MUIR, J. "Recovery of Iron from Overstrain." Phil. Trans. Roy. Soc., Vol. A, 193, p. 1, 1900.
85. MCADAM, D. J. (a) "Endurance and Impact Tests of Metals." Proc. Am. Soc. Test. Mat., Vol. XVI, Pt. II, p. 293. See also Vol. XVII, Pt. II, p. 599.
(b) "Alternating Torsion Tests." Am. Soc. Test. Mat., 1920.
(c) "An Alternating Torsion Machine." Am. Soc. Test. Mat., 1920.

86. McCAUSTLAND, E. J. "Effect of Low Temperature on the Recovery of Steel from Overstrain." Am. Soc. Min. Eng., 1906. Sci. Abs., 1906, No. 1176.
87. HUSBAUMER, E. "Repeated Stresses, Impact, Etc." Carnegie Scholarship Memoirs, Vol. 6, 1914. Iron & Steel Inst.
88. OLSEN, T. Y. "Olsen Vibrating Testing Machine." Elect. Rev., Apr. 17, 1908. Sci. Abs., 1908, No. 881.
89. OSMOND, FREMONI, and CARTAUD, "Les Modes de Deformation et de Rupture des Fers et des Aciers Doux." Revue de Metallurgie, Pt. I, 1904.
90. PEARSON, KARL "On Torsional Vibrations in Axles and Shafts." Drapers' Company Memoirs, Technical Series IV.
91. POPPLEWELL, W. C. (a) "Slow Reversals of Stress and Endurance of Steel." Inst. of Civ. Eng., 1913-14, Pt. III, p. 264. The Engineer London, Oct. 20, 1914.
(b) "The Resistance of Iron and Steel to Complete Reversals of Stress." Eng. Rev., Oct. 16, 1916. Jour. A. S. M. E., Jan., 1917.
92. PREUSS, E. (a) "Versuche über die Spannungsverteilung in Gelochten Zugstaben." Zeit. Ver. Deut. Ing., 1912, p. 1780.
(b) "Versuche über die Spannungsverteilung in Gekerbten Zugstaben." Zeit. Ver. Deut. Ing., 1913, p. 664.
(c) "Zur Geschichte der Dauerversuche mit Metallen." Baumaterialienkunde, 1906, XI, p. 245.
93. PRICHARD, H. S. (a) "The Effects of Straining Structural Steel and Wrought Iron." Trans. A. S. C. E., Vol. LXXX, p. 1429, 1916, with discussion following.
(b) "Overstrain and Fatigue Failure of Steel." Eng. News-Record, June 6, 1918, p. 1086.
94. RASCH, E. "Method for Determining Elastic and Critical Stresses in Materials by Means of Thermo-Electric Measurements." Proc. Int. Assoc. for Test. Mat., Art. VII, 1909.
95. READ, A. A. and GREAVES, R. H. "The Influence of Nickel on Some Copper-Aluminum Alloys." Inst. of Metals, 1914. Engineering, London, March 20, 1914.
96. REYNOLDS, O and SMITH, J. H. "On a Throw-Testing Machine for Reversals of Mean Stress." Phil. Trans. Roy. Soc., Series A, Vol. 199, 1902.
97. RITCHIE, J. B. (a) "Dissipation of Energy in Torsionally Oscillating Wires: Effects Produced by Changes of Temperature." Proc. Roy. Soc., Ed. 31, 1910-11. Sci. Abs., 1911, No. 1310.
(b) "Apparatus for Inducing Fatigue by Repeated Extensional and Rotational Strains." Proc. Roy. Soc. Edinburgh, 31, 1910-11. Sci. Abs., 1911, No. 1311.
98. ROGERS, F. (a) "Heat-Treatment and Fatigue of Iron and Steel." Jour. Iron and Steel Inst., No. 1, p. 484, 1905.

- (b) "Microscopic Effects Produced by the Action of Stresses on Metals." Soc. d'Encouragement Rev. de Metallurgie Mem.'s, Oct. 1, 1906.
- (c) "So-Called Crystallization Through Fatigue." Jour. Iron and Steel Inst., Sept., 1913, p. 392.
99. ROOS, J. O. (a) "On Endurance Tests of Machine Steel." Int. Assoc. Test. Mat., Paper V2a, 1912.
- (b) "Some Static and Dynamic Endurance Tests." Int. Assoc. Test. Mat., Paper V2b, 1912. Rev. de Metallurgie, Jan., 1913. Sci. Abs., 1913, No. 747.
100. ROSENHAIN, W. (a) "Further Observations on Slip Bands and Metallic Fractures." Proc. Roy. Soc., Vol. 74, 1900.
- (b) "The Plastic Yielding of Iron and Steel." Jour. Iron and Steel Inst., Vol. I, p. 335, 1904.
- (c) "Two Lectures on Steel." Proc. Inst. Mech. Eng., 1911, Pt. II, pp. 280-283.
- (d) "An Introduction to the Study of Physical Metallurgy." N. Y., 1914.
101. ROSENHAIN, W. and EWEN, D. "Inter-crystalline Cohesion in Metals." Jour. of the Inst. of Metals, No. 2, 1912, p. 149.
102. ROSENHAIN, W. and HUMFREY, J. C. W. "The Tenacity, Deformation, and Fracture of Soft Steel at High Temperature." Jour. of Iron and Steel Inst., No. 1, 1913, No. 87, p. 219.
103. ROWETT, F. E. (a) "Elastic Hysteresis of Steel." Proc. Roy. Soc., 1914, A, 89, p. 528.
- (b) "The Elastic Properties of Steel at Moderately High Temperatures." Proc. Roy. Soc., Vol. 91A, p. 291, 1914-15.
104. SANKEY, H. R. (a) "Vibratory Testing Machine." Mech. Eng., Nov. 11, 1905.
- (b) "Hand Bending Test." Engineering, London, Dec. 20, 1907. Engineering, London, Feb. 15, 1907. See No. 10.
105. SCHLINK, F. J. "Study of Mechanical Hysteresis." Eng. News-Record, Vol. 80, p. 1035, May 30, 1918.
106. SCHUCHART, A. "Resistance of Wire to Repeated Bending." Stahl und Eisen, July 1 and 8, 1908.
107. SMITH, J. H. (a) "Testing Machine for Reversals of Stress." Engineering, London, March 10, 1905.
- (b) "Fatigue Testing Machine." Engineering, London, July 23, 1909.
- (c) "Experiments on Fatigue of Metals." Jour. Iron and Steel Inst., 2, 1910, p. 246. Sci. Abs., 1911, No. 568.
108. SMITH, C. A. M. "On Stress Distribution During Tension Tests." Engineering, London, Dec. 10, 1909, p. 796.
109. SMITH, J. H. and WEDGWOOD, G. A. "Stress-Strain Loops for Steel in the Cyclic State." Iron and Steel Inst., 1915.
110. SONDERICKER, J. "Description of Some Repeated Stress Experiments." Tech. Quart., Apr., 1892.

111. SPANGENBERG, "Über das Verhalten der Metalle bei Wiederholten Anstrengungen." *Zeitschrift für Bauwesen*, 1874-1875. See also "Hand-Book of Testing," A Martens; or "Testing of Materials," Unwin.
112. STANTON, T. E. (a) "Alternating Stress-Testing Machine at the National Physical Laboratory." *Engineering*, London, Feb. 17, 1905.
(b) "Repeated Impact Testing Machine." *Engineering*, London, 82, July 13, 1906, p. 33. *Sci. Abs.*, 1906, No. 1520.
(c) "A Factor in the Design of Machine Details." *Engineering*, London, Apr. 19, 1907, p. 505.
(d) "A New Fatigue Test for Iron and Steel." *Jour. Iron and Steel Inst.*, No. 1, p. 54, 1908.
(e) "Recent Researches Made at the National Physical Laboratory on the Resistance of Metals to Alternating Stress." *Int. Congress for Test. Mat.*, Paper VI, 1912.
(f) "Resistance of Wood to Stress Reversals." *Engineering*, London, June 23, 1916, p. 605.
113. STANTON and BAIRSTOW, (a) "On the Resistance of Iron and Steel to Reversals of Stress." *Proc. Inst. C. E., Brit.*, CLXVI, Vol. 166, p. 78, 1906; also *Engineering*, London, Vol. LXXIX, p. 201, 1905.
(b) "The Resistance of Materials to Impact." *Proc. Inst. Mech. Eng.*, No. 4, 1908.
114. STANTON and BATSON, "On the Fatigue Resistance of Mild Steel Under Various Conditions of Stress Distribution." *Brit. Assoc.*, Sept. 15, 1916.
115. STANTON and PANNELL, "Experiments on the Strength and Fatigue Properties of Welded Joints in Iron and Steel." *Proc. Inst. C. E.*, Vol. CLXXXVIII, p. 1, 1911.
116. STEAD, J. E. "Iron, Carbon, and Phosphorus." *Iron and Steel Inst. Jour.*, 1915. *Engineering*, London, May 21, 1915, p. 569.
117. STEAD and RICHARDS, (a) "Sorbitic Steel Rails." *Iron and Steel Inst. Jour.*, 1915. 1903, II, p. 141.
(b) "Restoration of Dangerously Crystallized Steel by Heat Treatment." *Ibid.*, p. 119, 1903.
(c) "Overheated Steel." *Ibid.*, p. 84, 1905.
118. STROMEYER, C. E. (a) "The Determination of Fatigue Limits Under Alternating Stress Conditions." *Proc. Roy. Soc., A*, 90, 1914, p. 114.
(b) "Memorandum of the Chief Engineer of the Manchester (England) Steam Users Association." 1913.
(c) "Elasticity and Endurance of Steam Pipes." *Trans. Inst. of Naval Arch. (Brit.)*, 1914; also *Engineering*, London.
(d) "Fatigue of Metals." *Sheffield Sec. of Eng. and Met. Proc.*, 1914.
(e) "The Law of Fatigue Applied to Crankshaft Failures." *Inst. of Naval Arch.*, 1915.

119. THEARLE, S. J. P. "Note on Some Cases of Fatigue in the Steel Material of Steamers." Inst. Naval Arch., June, 1913. Also Engineering, London, June 27, 1913, p. 891.
120. THOMPSON, F. C. "Surface-Tension Effects in Metals." Iron and Steel Inst., May 5, 1916. Engineering, London, May 19, 1916.
121. THURSTON, R. H. "Text-Book of Materials of Construction." p. 348.
122. TOBUSCH, H. "Elastic and Magnetic Hysteresis." Ann. de Physique, 26, 3. Sci. Abs. A, 1908, No. 1482.
123. TURNER, C. A. P. "The Thermo-Electric Determination of Stress." Trans. Am. Soc. of C. E., Jan., 1902, Vol. 48, p. 140.
124. TURNER, L. B. "The Strength of Steel in Compound Stress and Endurance Under Repetition of Stress." Engineering, London, July 28 to Sept. 8, 1911. Sci. Abs., 1911, No. 1315.
125. UNWIN, W. C. (a) "Experiments on Rotating Bars at Different Temperatures." Proc. Inst. Civ. Eng., CLXVI. Sci. Abs., 1907, No. 373.
 (b) "General Considerations on Safe Working Limits of Stress." Testing of Materials of Construction, Chap. XVI, 1910 ed.
 (c) "Presidential Address." Inst. of C. E. (Brit.) for 1911, Pt. I; also "The Testing of Materials of Construction," Engineering, London, Nov. 10, 1911, with editorial comment, p. 13.
126. UPTON and LEWIS, "The Fatigue Failure of Metals." Am. Mach., Oct. 17 and 24, 1912, p. 633.
127. VAN DEN BROCK, J. A. "The Effects of Cold-Working on the Elastic Properties of Steel." Engineering, London, July 26, 1918, p. 99. Iron and Steel Inst., May 3, 1918.
128. VAN ORNUM, "The Fatigue of Cement Products." Trans. Am. Soc. of C. E., Vol. 51, p. 443, 1903. "The Fatigue of Concrete," Vol. 58, p. 294, 1907.
129. (Various Writers.) "1910 Enquete sur la fatigue des Metaux." La Technique Moderne, Vol. 2, pp. 19-21, 83-84, 151-154, 210-214, 280-284, 345-347, 1910.
130. WARBURG and HENSE, "Elastic 'After-Effect' and Hysteresis." Deut. Phy. Gesell., June 30, 1915.
131. WATERTOWN ARSENAL, "Tests of Metals." 1888 to 1895, 1890 to 1909.
132. WÖHLER, A. (a) "Zeitschrift fur Bauwesen." VIII, p. 642, 1858; X, p. 583, 1860.
 (b) "Über die Festigkeitversuche mit Eisen und Stahl." A good account of these results is given in English in Engineering, London, Vol. XI, 1871. A summary of Wöhler's work is given in "The Testing of Materials of Construction," by Unwin. The original publication of Wöhler's results was in Zeitschrift fur Bauwesen, Vols. X, XIII, XVI, and XX, p. 83, 1870.

Supplementary Note.—Since the preparation of the manuscript of this bulletin an important piece of research in the fatigue of metals has been reported from the British National Physical Laboratory by H. J. Gough. This report is given in The Engineer, London August 12, 1921, and an abstract is given in "Mechanical Engineering," October, 1921.

LIST OF

PUBLICATIONS OF THE ENGINEERING EXPERIMENT STATION

Bulletin No. 1. Tests of Reinforced Concrete Beams, by Arthur N. Talbot. 1904. *None available.*

Circular No. 1. High-Speed Tool Steels, by L. P. Breckenridge. 1905. *None available.*

Bulletin No. 2. Tests of High-Speed Tool Steels on Cast Iron, by L. P. Breckenridge and Henry B. Dirks. 1905. *None available.*

Circular No. 2. Drainage of Earth Roads, by Ira O. Baker. 1906. *None available.*

Circular No. 3. Fuel Tests with Illinois Coal (Compiled from tests made by the Technological Branch of the U. S. G. S., at the St. Louis, Mo., Fuel Testing Plant, 1904-1907), by L. P. Breckenridge and Paul Diserens. 1908. *Thirty cents.*

Bulletin No. 3. The Engineering Experiment Station of the University of Illinois, by L. P. Breckenridge. 1906. *None available.*

Bulletin No. 4. Tests of Reinforced Concrete Beams, Series of 1905, by Arthur N. Talbot. 1906. *Forty-five cents.*

Bulletin No. 5. Resistance of Tubes to Collapse, by Albert P. Carman and M. L. Carr. 1906. *None available.*

Bulletin No. 6. Holding Power of Railroad Spikes, by Roy I. Webber. 1906. *None available.*

Bulletin No. 7. Fuel Tests with Illinois Coals, by L. P. Breckenridge, S. W. Parr, and Henry B. Dirks. 1906. *None available.*

Bulletin No. 8. Tests of Concrete: I, Shear; II, Bond, by Arthur N. Talbot. 1906. *None available.*

Bulletin No. 9. An Extension of the Dewey Decimal System of Classification Applied to the Engineering Industries, by L. P. Breckenridge and G. A. Goodenough. 1906. Revised Edition, 1912. *Fifty cents.*

Bulletin No. 10. Tests of Concrete and Reinforced Concrete Columns, Series of 1906, by Arthur N. Talbot. 1907. *None available.*

Bulletin No. 11. The Effect of Scale on the Transmission of Heat through Locomotive Boiler Tubes, by Edward C. Schmidt and John M. Snodgrass. 1907. *None available.*

Bulletin No. 12. Tests of Reinforced Concrete T-Beams, Series of 1906, by Arthur N. Talbot. 1907. *None available.*

Bulletin No. 13. An Extension of the Dewey Decimal System of Classification Applied to Architecture and Building, by N. Clifford Rieker. 1906. *None available.*

Bulletin No. 14. Tests of Reinforced Concrete Beams, Series of 1906, by Arthur N. Talbot. 1907. *None available.*

Bulletin No. 15. How to Burn Illinois Coal without Smoke, by L. P. Breckenridge. 1907. *None available.*

Bulletin No. 16. A Study of Roof Trusses, by N. Clifford Ricker. 1907. *None available.*

Bulletin No. 17. The Weathering of Coal, by S. W. Parr, N. D. Hamilton, and W. F. Wheeler. 1907. *None available.*

Bulletin No. 18. The Strength of Chain Links, by G. A. Goodenough and L. E. Moore. 1907. *Forty cents.*

Bulletin No. 19. Comparative Tests of Carbon, Metallized Carbon, and Tantalum Filament Lamps, by T. H. Amrine. 1907. *None available.*

Bulletin No. 20. Tests of Concrete and Reinforced Concrete Columns, Series of 1907, by Arthur N. Talbot. 1907. *None available.*

Bulletin No. 21. Tests of a Liquid Air Plant, by C. S. Hudson and C. M. Garland. 1908. *Fifteen cents.*

Bulletin No. 22. Tests of Cast-Iron and Reinforced Concrete Culvert Pipe, by Arthur N. Talbot. 1908. *None available.*

Bulletin No. 23. Voids, Settlement, and Weight of Crushed Stone, by Ira O. Baker. 1908. *Fifteen cents.*

**Bulletin No. 24.* The Modification of Illinois Coal by Low Temperature Distillation, by S. W. Parr and C. K. Francis. 1908. *Thirty cents.*

Bulletin No. 25. Lighting Country Homes by Private Electric Plants, by T. H. Amrine. 1908. *Twenty cents.*

Bulletin No. 26. High Steam-Pressure in Locomotive Service. A Review of a Report to the Carnegie Institution of Washington, by W. F. M. Goss. 1908. *Twenty-five cents.*

Bulletin No. 27. Tests of Brick Columns and Terra Cotta Block Columns, by Arthur N. Talbot and Duff A. Abrams. 1908. *Twenty-five cents.*

Bulletin No. 28. A Test of Three Large Reinforced Concrete Beams, by Arthur N. Talbot. 1908. *Fifteen cents.*

Bulletin No. 29. Tests of Reinforced Concrete Beams: Resistance to Web Stresses, Series of 1907 and 1908, by Arthur N. Talbot. 1909. *Forty-five cents.*

Bulletin No. 30. On the Rate of Formation of Carbon Monoxide in Gas Producers, by J. K. Clement, L. H. Adams, and C. N. Haskins. 1909. *Twenty-five cents.*

Bulletin No. 31. Tests with House-Heating Boilers, by J. M. Snodgrass. 1909. *Fifty-five cents.*

Bulletin No. 32. The Occluded Gases in Coal, by S. W. Parr and Perry Barker. 1909. *Fifteen cents.*

Bulletin No. 33. Tests of Tungsten Lamps, by T. H. Amrine and A. Guell. 1909. *Twenty cents.*

**Bulletin No. 34.* Tests of Two Types of Tile-Roof Furnaces under a Water-Tube Boiler, by J. M. Snodgrass. 1909. *Fifteen cents.*

* A limited number of copies of bulletins starred are available for free distribution.

Bulletin No. 35. A Study of Base and Bearing Plates for Columns and Beams, by N. Clifford Ricker. 1909. *None available.*

Bulletin No. 36. The Thermal Conductivity of Fire-Clay at High Temperatures, by J. K. Clement and W. L. Egy. 1909. *Twenty cents.*

Bulletin No. 37. Unit Coal and the Composition of Coal Ash, by S. W. Parr and W. F. Wheeler. 1909. *None available.*

Bulletin No. 38. The Weathering of Coal, by S. W. Parr and W. F. Wheeler. 1909. *Twenty-five cents.*

**Bulletin No. 39.* Tests of Washed Grades of Illinois Coal, by C. S. McGovney. 1909. *Seventy-five cents.*

Bulletin No. 40. A Study in Heat Transmission, by J. K. Clement and C. M. Garland. 1909. *Ten cents.*

Bulletin No. 41. Tests of Timber Beams, by Arthur N. Talbot. 1909. *Thirty-five cents.*

**Bulletin No. 42.* The Effect of Keyways on the Strength of Shafts, by Herbert F. Moore. 1909. *Ten cents.*

Bulletin No. 43. Freight Train Resistance, by Edward C. Schmidt. 1910. *Seventy-five cents.*

Bulletin No. 44. An Investigation of Built-up Columns under Load, by Arthur N. Talbot and Herbert F. Moore. 1910. *Thirty-five cents.*

**Bulletin No. 45.* The Strength of Oxyacetylene Welds in Steel, by Herbert L. Whittemore. 1910. *Thirty-five cents.*

Bulletin No. 46. The Spontaneous Combustion of Coal, by S. W. Parr and F. W. Kressman. 1910. *Forty-five cents.*

**Bulletin No. 47.* Magnetic Properties of Heusler Alloys, by Edward B. Stephenson. 1910. *Twenty-five cents.*

**Bulletin No. 48.* Resistance to Flow through Locomotive Water Columns, by Arthur N. Talbot and Melvin L. Enger. 1911. *Fifty cents.*

**Bulletin No. 49.* Tests of Nickel-Steel Riveted Joints, by Arthur N. Talbot and Herbert F. Moore. 1911. *Thirty cents.*

**Bulletin No. 50.* Tests of a Suction Gas Producer, by C. M. Garland and A. P. Kratz. 1911. *Fifty cents.*

Bulletin No. 51. Street Lighting, by J. M. Bryant and H. G. Hake. 1911. *Thirty-five cents.*

**Bulletin No. 52.* An Investigation of the Strength of Rolled Zinc, by Herbert F. Moore. 1911. *Fifteen cents.*

**Bulletin No. 53.* Inductance of Coils, by Morgan Brooks and H. M. Turner. 1912. *Forty cents.*

**Bulletin No. 54.* Mechanical Stresses in Transmission Lines, by A. Guell. 1912. *Twenty cents.*

**Bulletin No. 55.* Starting Currents of Transformers, with Special Reference to Transformers with Silicon Steel Cores, by Trygve D. Yensen. 1912. *Twenty cents.*

* A limited number of copies of bulletins starred are available for free distribution.

**Bulletin No. 56. Tests of Columns: An Investigation of the Value of Concrete as Reinforcement for Structural Steel Columns*, by Arthur N. Talbot and Arthur R. Lord. 1912. *Twenty-five cents.*

**Bulletin No. 57. Superheated Steam in Locomotive Service. A Review of Publication No. 127 of the Carnegie Institution of Washington*, by W. F. M. Goss. 1912. *Forty cents.*

**Bulletin No. 58. A New Analysis of the Cylinder Performance of Reciprocating Engines*, by J. Paul Clayton. 1912. *Sixty cents.*

**Bulletin No. 59. The Effect of Cold Weather upon Train Resistance and Tonnage Rating*, by Edward C. Schmidt and F. W. Marquis. 1912. *Twenty cents.*

Bulletin No. 60. The Coking of Coal at Low Temperature, with a Preliminary Study of the By-Products, by S. W. Parr and H. L. Olin. 1912. *Twenty-five cents.*

**Bulletin No. 61. Characteristics and Limitations of the Series Transformer*, by A. R. Anderson and H. R. Woodrow. 1912. *Twenty-five cents.*

Bulletin No. 62. The Electron Theory of Magnetism, by Elmer H. Williams. 1912. *Thirty-five cents.*

Bulletin No. 63. Entropy-Temperature and Transmission Diagrams for Air, by C. R. Richards. 1913. *Twenty-five cents.*

**Bulletin No. 64. Tests of Reinforced Concrete Buildings under Load*, by Arthur N. Talbot and Willis A. Slater. 1913. *Fifty cents.*

**Bulletin No. 65. The Steam Consumption of Locomotive Engines from the Indicator Diagrams*, by J. Paul Clayton. 1913. *Forty cents.*

Bulletin No. 66. The Properties of Saturated and Superheated Ammonia Vapor, by G. A. Goodenough and William Earl Mosher. 1913. *Fifty cents.*

Bulletin No. 67. Reinforced Concrete Wall Footings and Column Footings, by Arthur N. Talbot. 1913. *None available.*

Bulletin No. 68. The Strength of I-Beams in Flexure, by Herbert F. Moore. 1913. *Twenty cents.*

Bulletin No. 69. Coal Washing in Illinois, by F. C. Lincoln. 1913. *Fifty cents.*

Bulletin No. 70. The Mortar-Making Qualities of Illinois Sands, by C. C. Wiley. 1913. *Twenty cents.*

Bulletin No. 71. Tests of Bond between Concrete and Steel, by Duff A. Abrams. 1913. *One dollar.*

**Bulletin No. 72. Magnetic and Other Properties of Electrolytic Iron Melted in Vacuo*, by Trygve D. Yensen. 1914. *Forty cents.*

Bulletin No. 73. Acoustics of Auditoriums, by F. R. Watson. 1914. *Twenty cents.*

**Bulletin No. 74. The Tractive Resistance of a 28-Ton Electric Car*, by Harold H. Dunn. 1914. *Twenty-five cents.*

Bulletin No. 75. Thermal Properties of Steam, by G. A. Goodenough. 1914. *Thirty-five cents.*

* A limited number of copies of bulletins starred are available for free distribution.

Bulletin No. 76. The Analysis of Coal with Phenol as a Solvent, by S. W. Parr and H. F. Hadley. 1914. *Twenty-five cents.*

**Bulletin No. 77.* The Effect of Boron upon the Magnetic and Other Properties of Electrolytic Iron Melted in Vacuo, by Trygve D. Yensen. 1915. *Ten cents.*

Bulletin No. 78. A Study of Boiler Losses, by A. P. Kratz. 1915. *Thirty five cents.*

**Bulletin No. 79.* The Coking of Coal at Low Temperatures, with Special Reference to the Properties and Composition of the Products, by S. W. Parr and H. L. Olin. 1915. *Twenty-five cents.*

Bulletin No. 80. Wind Stresses in the Steel Frames of Office Buildings, by W. M. Wilson and G. A. Maney. 1915. *Fifty cents.*

Bulletin No. 81. Influence of Temperature on the Strength of Concrete, by A. B. McDaniel. 1915. *Fifteen cents.*

Bulletin No. 82. Laboratory Tests of a Consolidation Locomotive, by E. C. Schmidt, J. M. Snodgrass, and R. B. Keller. 1915. *Sixty-five cents.*

**Bulletin No. 83.* Magnetic and Other Properties of Iron-Silicon Alloys, Melted in Vacuo, by Trygve D. Yensen. 1915. *Thirty-five cents.*

Bulletin No. 84. Tests of Reinforced Concrete Flat Slab Structures, by Arthur N. Talbot and W. A. Slater. 1916. *Sixty-five cents.*

**Bulletin No. 85.* The Strength and Stiffness of Steel under Biaxial Loading, by A. J. Becker. 1916. *Thirty-five cents.*

Bulletin No. 86. The Strength of I-Beams and Girders, by Herbert F. Moore and W. M. Wilson. 1916. *Thirty cents.*

**Bulletin No. 87.* Correction of Echoes in the Auditorium, University of Illinois, by F. R. Watson and J. M. White. 1916. *Fifteen cents.*

Bulletin No. 88. Dry Preparation of Bituminous Coal at Illinois Mines, by E. A. Holbrook. 1916. *Seventy cents.*

Bulletin No. 89. Specific Gravity Studies of Illinois Coal, by Merle L. Nebel. 1916. *Thirty cents.*

**Bulletin No. 90.* Some Graphical Solutions of Electric Railway Problems, by A. M. Buck. 1916. *Twenty cents.*

Bulletin No. 91. Subsidence Resulting from Mining, by L. E. Young and H. H. Stoek. 1916. *None available.*

**Bulletin No. 92.* The Tractive Resistance on Curves of a 28-Ton Electric Car, by E. C. Schmidt and H. H. Dunn. 1916. *Twenty-five cents.*

**Bulletin No. 93.* A Preliminary Study of the Alloys of Chromium, Copper, and Nickel, by D. F. McFarland and O. E. Harder. 1916. *Thirty cents.*

**Bulletin No. 94.* The Embrittling Action of Sodium Hydroxide on Soft Steel, by S. W. Parr. 1917. *Thirty cents.*

**Bulletin No. 95.* Magnetic and Other Properties of Iron-Aluminum Alloys Melted in Vacuo, by T. D. Yensen and W. A. Gatward. 1917. *Twenty-five cents.*

* A limited number of copies of bulletins starred are available for free distribution.

**Bulletin No. 96.* The Effect of Mouthpieces on the Flow of Water through a Submerged Short Pipe, by Fred B Seely. 1917. *Twenty-five cents.*

**Bulletin No. 97.* Effects of Storage upon the Properties of Coal, by S. W. Parr. 1917. *Twenty cents.*

**Bulletin No. 98.* Tests of Oxyacetylene Welded Joints in Steel Plates, by Herbert F. Moore. 1917. *Ten cents.*

Circular No. 4. The Economical Purchase and Use of Coal for Heating Homes, with Special Reference to Conditions in Illinois. 1917. *Ten cents.*

**Bulletin No. 99.* The Collapse of Short Thin Tubes, by A. P. Carman, 1917. *Twenty cents.*

**Circular No. 5.* The Utilization of Pyrite Occurring in Illinois Bituminous Coal, by E. A. Holbrook. 1917. *Twenty cents.*

**Bulletin No. 100.* Percentage of Extraction of Bituminous Coal with Special Reference to Illinois Conditions, by C. M. Young. 1917.

**Bulletin No. 101.* Comparative Tests of Six Sizes of Illinois Coal on a Mikado Locomotive, by E. C. Schmidt, J. M. Snodgrass, and O. S. Beyer, Jr. 1917. *Fifty cents.*

**Bulletin No. 102.* A Study of the Heat Transmission of Building Materials, by A. C. Willard and L. C. Lichty. 1917. *Twenty-five cents.*

**Bulletin No. 103.* An Investigation of Twist Drills, by B. Benedict and W. P. Lukens. 1917. *Sixty cents.*

**Bulletin No. 104.* Tests to Determine the Rigidity of Riveted Joints of Steel Structures, by W. M. Wilson and H. F. Moore. 1917. *Twenty-five cents.*

Circular No. 6. The Storage of Bituminous Coal, by H. H. Stoek. 1918. *Forty cents.*

Circular No. 7. Fuel Economy in the Operation of Hand Fired Power Plants. 1918. *Twenty cents.*

**Bulletin No. 105.* Hydraulic Experiments with Valves, Orifices, Hose, Nozzles, and Orifice Buckets, by Arthur N. Talbot, Fred B Seely, Virgil R. Fleming, and Melvin L. Enger. 1918. *Thirty-five cents.*

**Bulletin No. 106.* Test of a Flat Slab Floor of the Western Newspaper Union Building, by Arthur N. Talbot and Harrison F. Gonnerman. 1918. *Twenty cents.*

Circular No. 8. The Economical Use of Coal in Railway Locomotives. 1918. *Twenty cents.*

**Bulletin No. 107.* Analysis and Tests of Rigidly Connected Reinforced Concrete Frames, by Mikishi Abe. 1918. *Fifty cents.*

**Bulletin No. 108.* Analysis of Statically Indeterminate Structures by the Slope Deflection Method, by W. M. Wilson, F. E. Richart, and Camillo Weiss. 1918. *One dollar.*

**Bulletin No. 109.* The Pipe Orifice as a Means of Measuring Flow of Water through a Pipe, by R. E. Davis and H. H. Jordan, 1918. *Twenty-five cents.*

**Bulletin No. 110.* Passenger Train Resistance, by E. C. Schmidt and H. H. Dunn. 1918. *Twenty cents.*

* A limited number of copies of bulletins starred are available for free distribution.

- **Bulletin No. 111.* A Study of the Forms in which Sulphur Occurs in Coal, by A. R. Powell with S. W. Parr. 1919. *Thirty cents.*
- **Bulletin No. 112.* Report of Progress in Warm-Air Furnace Research, by A. C. Willard. 1919. *Thirty-five cents.*
- **Bulletin No. 113.* Panel System of Coal Mining. A Graphical Study of Percentage of Extraction, by C. M. Young. 1919.
- **Bulletin No. 114.* Corona Discharge, by Earle H. Warner with Jakob Kunz. 1919. *Seventy-five cents.*
- **Bulletin No. 115.* The Relation between the Elastic Strengths of Steel in Tension, Compression, and Shear, by F. B. Seely and W. J. Putnam. 1920. *Twenty cents.*
- Bulletin No. 116.* Bituminous Coal Storage Practice, by H. H. Stoek, C. W. Hippard, and W. D. Langtry. 1920. *Seventy-five cents.*
- **Bulletin No. 117.* Emissivity of Heat from Various Surfaces, by V. S. Day. 1920. *Twenty cents.*
- **Bulletin No. 118.* Dissolved Gases in Glass, by E. W. Washburn, F. F. Footitt, and E. N. Bunting. 1920. *Twenty cents.*
- **Bulletin No. 119.* Some Conditions Affecting the Usefulness of Iron Oxide for City Gas Purification, by W. A. Dunkley. 1921.
- **Circular No. 9.* The Functions of the Engineering Experiment Station of the University of Illinois, by C. R. Richards. 1921.
- **Bulletin No. 120.* Investigation of Warm-Air Furnaces and Heating Systems, by A. C. Willard, A. P. Kratz, and V. S. Day, 1921. *Seventy-five cents.*
- **Bulletin No. 121.* The Volute in Architecture and Architectural Decoration, by Rexford Newcomb. 1921. *Forty-five cents.*
- **Bulletin No. 122.* The Thermal Conductivity and Diffusivity of Concrete, by A. P. Carman and R. A. Nelson. 1921. *Twenty cents.*
- **Bulletin No. 123.* Studies on Cooling of Fresh Concrete in Freezing Weather, by Tokujiro Yoshida. 1921. *Thirty cents.*
- Bulletin No. 124.* An Investigation of the Fatigue of Metals, by H. F. Moore and J. B. Koppers. 1921. *Ninety-five cents.*

* A limited number of copies of bulletins starred are available for free distribution.

THE UNIVERSITY OF ILLINOIS

THE STATE UNIVERSITY

Urbana

DAVID KINLEY, Ph.D., LL.D., President

THE UNIVERSITY INCLUDES THE FOLLOWING DEPARTMENTS:

The Graduate School

The College of Liberal Arts and Sciences (Ancient and Modern Languages and Literatures; History, Economics, Political Science, Sociology; Philosophy, Psychology, Education; Mathematics; Astronomy; Geology; Physics; Chemistry; Botany, Zoology, Entomology; Physiology; Art and Design)

The College of Commerce and Business Administration (General Business, Banking, Insurance, Accountancy, Railway Administration, Foreign Commerce; Courses for Commercial Teachers and Commercial and Civic Secretaries)

The College of Engineering (Architecture; Architectural, Ceramic, Civil, Electrical, Mechanical, Mining, Municipal and Sanitary, and Railway Engineering; General Engineering Physics)

The College of Agriculture (Agronomy; Animal Husbandry; Dairy Husbandry; Horticulture and Landscape Gardening; Agricultural Extension; Teachers' Course; Home Economics)

The College of Law (Three-year and four-year curriculums based on two years and one year of college work respectively)

The College of Education (including the Bureau of Educational Research)

The Curriculum in Journalism

The Curriculums in Chemistry and Chemical Engineering

The School of Railway Engineering and Administration

The School of Music (four-year curriculum)

The Library School (two-year curriculum for college graduates)

The College of Medicine (in Chicago)

The College of Dentistry (in Chicago)

The School of Pharmacy (in Chicago; Ph.G. and Ph.C. curriculums)

The Summer Session (eight weeks)

Experiment Stations and Scientific Bureaus: U. S. Agricultural Experiment Station; Engineering Experiment Station; State Laboratory of Natural History; State Entomologist's Office; Biological Experiment Station on Illinois River; State Water Survey; State Geological Survey; U. S. Bureau of Mines Experiment Station.

The library collections contain (April 1, 1921) 497,361 volumes and 117,508 pamphlets.

For catalogs and information address

THE REGISTRAR
Urbana, Illinois

89085980027



B89085980027A