DOMUS I & DYMAXION

TWO PROPOSED CONCEPTS FOR LUNAR HABITATS

Space Architecture Monograph Series, Volume 6

Designs by

Christine M. Brinlee
David S. Erdmann
Lydia H. Matheson
Wayne A. McCambridge
Janis Huebner-Mothes
Steve M. Schmidt
Agustus J. Wellings

Text written by

Janis Huebner-Mothes and Gary T. Moore

Illustrations by

Steve M. Schmidt and Wayne A. Mc Cambridge

Report compiled by

Patrick J. Rebolz and Joseph P. Fieber

Report edited by

Gary T. Moore and David S. Erdmann

**Space Architecture Design Group
Department of Architecture and
Center for Architecture and Urban Planning Research
University of Wisconsin-Milwaukee**

June 1993

**DOMUS I AND DYMAXION:
TWO CONCEPT DESIGNS FOR LUNAR HABITATS**
Janis Huebner-Moths, Steven M. Schmidt, Wayne A. Mc Cambridge,
David S. Erdmann, and Gary T. Moore

ABSTRACT

Two concept designs for lunar habitats are explored and developed in this monograph based on human factors/environment-behavior considerations. Attention is given to initial operating configuration design requirements, different technological options, and 12 different habitat concepts. The first developed concept, Domus 1, is a pressurized self-supporting membrane structure (PSSMS) proposed by Chow and Lin, and the second a Dymaxion dome structure based on the work of Buckminster Fuller. The master plan, construction sequencing, technical subsystems, and interior configuration of both of these concepts are presented. Domus [consists of three entrance/EVA modules connected to a rigidized, inflatable torus containing research laboratories and mission control, and a domed interior of an rigidized, inflatable ellipsoid containing crew quarters and crew support facility. Dymaxion consists of three hard-module research laboratories/EVA chambers, a mission control core, and a two-floor habitation inflatable. The relative advantages and limitations of the PSSMS and dymaxion concepts are briefly reviewed.

**OTHER MONOGRAPHS IN THE SPACE ARCHITECTURE
MONOGRAPH SERIES**

Space Architecture: Lunar Base Scenarios, by A.J. Schnarsky, E.G. Cordes, T.M. Crabb & M.K. Jacobs (edited by E.G. Cordes, G.T. Moore & S.J. Frahm). ISBN 0-938744-59-3, R88-1, 1988; pp. vi + 80, illus; \$10.00.

Genesis Lunar Outpost: Program/Requirements Document for an Early Stage Lunar Outpost, by D.J. Baschiera & 12 others (edited by E.G. Cordes). ISBN 0-938744-61-5, R89-1, 1989; pp. xix + 89, illus; \$10.00.

Genesis Lunar Outpost: Criteria and Design, by D.J. Baschiera, J.P. Fieber, T.L. Hansmann, J. Huebner-Moths & G.T. Moore (edited by T.L. Hansmann & G.T. Moore). ISBN 0-938744-69-0, R90-1, 1990; pp. xii + 107, illus; \$10.00.

Genesis II: Advanced Lunar Outpost, by J.P. Fieber, J. Huebner-Moths & K.L. Paruleski (edited by G.T. Moore). ISBN 0-938744-74-7, R91-2, 1991; pp. xvi + 72, illus; \$10.00.

Pax Permanent Martian Base: Space Architecture for the First Human Habitation on Mars, by J. Huebner-Moths, J.P. Fieber, P.J. Rebholz & K.L. Paruleski (edited by G.T. Moore). ISBN 0-938744-79-8, R92-2, 1992; pp. xi + 67, illus; \$10.00.

PUBLICATIONS IN ARCHITECTURE AND URBAN PLANNING

Center for Architecture and Urban Planning Research
University of Wisconsin-Milwaukee
Milwaukee, WI 53201-0413

Report Number R95-1
ISBN 0-938744-91-7

Additional copies of this monograph are available for \$ 15.00 prepaid by writing to the above address.

EXECUTIVE SUMMARY

Two concept designs for lunar habitat missions are explored and developed in this monograph. In contrast to other work on lunar habitat designs, the driving force was habitation objectives and habitation performance requirements based on human factors/environment-behavior considerations. Attention was given to site selection and site planning requirements, first lunar outpost requirements, and initial operating configuration design requirements (both quantitative and qualitative). After review of 5 technological options and 12 previously published lunar habitat concept proposals, it was decided to further explore two concepts. The first is a pressurized self-supporting membrane structure (PSSMS) proposed by Philip Chow and T.Y. Lin, and the second a Dymaxion dome structure based on the work of Buckminster Fuller.

The master plan, construction sequencing, building system, technical subsystems, and interior configuration of both of these concepts are presented in this monograph.

Domus I consists of three entrance/EVA modules connected to a rigidized, inflatable torus containing all research laboratories and mission control, and a domed interior of an rigidized, inflatable ellipsoid containing all crew quarters and the crew support facility. *Dymaxion* consists of three hard module research laboratories/EVA chambers, a mission control core, and a two-floor habitation inflatable. The relative advantages and limitations of the PSSMS and dymaxion concepts are briefly reviewed.

Domus I is the result of a feasibility study of the Chow and Lin PSSMS concept on the lunar surface. The results of this design analysis indicate the concept is very feasible from habitability, human factors, and environment-behavior considerations. Technical details have already been published in the aerospace literature. The PSSMS structure is easily able to be made habitable. The torus versus the inner part of the ellipsoid allows easy separation of work from living areas. The two floor possibility in the ellipsoid allow separation of public crew support spaces from private crew quarters. Orientation and circulation are clear. Translation pathways allow for unobstructed movements of components and crew. Dual egress is assured. Variety of space within tight quantitative space limitations is accomplished. Creating two separate environments within one envelope—the torus and the domed center of the ellipsoid—lessens the number of materials interfacing with one another. In sum, the concept seems extremely

feasible and deserves most serious exploration by the various lunar program offices at NASA.

The *Dymaxion* principle—not previously published in the aerospace literature, but seeing its first exploration in the current study—also deserves further exploration.

PREFACE AND ACKNOWLEDGEMENTS

Since 1987, the University of Wisconsin-Milwaukee School of Architecture and Urban Planning has been actively involved in the investigation, research, and design conceptualization of extraterrestrial habitation and laboratory facilities. Through our involvement with the NASA/Universities Space Research Association Advanced Design Program (NASA/USRA ADP), design requirements together with a Martian and six lunar base conceptual proposals have been created. These have been the catalysts for over 60 presentations and lectures, research papers, technical reports, and interviews and articles.

The 1992-1993 ADP is the beginning of a second, 3-year cycle grant received from NASA/USRA. Our continuation as a contributor to the aerospace community offers an opportunity to remain in the mainstream of current and future projects. We continue to build upon past endeavors in the pursuit of education and sophistication in our design proposals.

During the course of the studies, professional consultants from the Johnson Space Center (JSC) were contacted, questioned, and subsequently offered valuable insight and answers. John Connolly of the Planetary Projects Office at JSC served as a primary consultant on construction technology. In addition, as the proposal for the feasibility study was selected, further contact was made with Phillip Chow of T.Y. Lin International. The Meroform Company offered expert advice on spaceframe trusswork. An interim review conducted in the company of retired Wisconsin astronaut, Dan Brandenstein, proved extremely beneficial. His review and suggestions served as a catalyst for major design revisions.

Our thanks is extended to Jeri Brown and Deborah Neubek of NASA Johnson Space Center for the supporting documents detailing the First Lunar Outpost requirements. Section 2.0 in this report are derived from two volumes by Carpenter (1992) unless otherwise noted.

We would like to thank NASA and the Universities Space Research Association for their continued support of our work. Appreciation is extended to the Johnson Space Center. Specifically, we would like to thank the following personnel for critical feedback and suggestions: Dan Brandenstein of IBM/Houston; Deborah J. Neubek, Jeri Brown and John F. Connolly of NASA/Johnson Space Center; Alan Adams of NASA/Marshall Space Flight Center; and Jon Davey, Mark Roth and Daniel Rhone of the University of Wisconsin-Milwaukee School of Architecture and Urban Planning.

Finally we would like to acknowledge the support of the administration and faculty of the School of Architecture and Urban Planning. Professional careers in aerospace have been a result of the ADP and the SARUP encouragement. We would like to extend deep appreciation for the extensive time and creative talent exhibited by the spring Space Architecture Design Studio team, their efforts resulting in the final design products, *Domus I* and *Dymaxion*.

Gary T. Moore, Ph.D.
Professor

Table of Contents

EXECUTIVE SUMMARY	iii		
PREFACE AND ACKNOWLEDGEMENTS	v		
1.0 OBJECTIVES AND PROCEDURE	1		
1.1 Objectives of Lunar Base Proposals	1		
1.2 Project Goals	1		
1.3 Design Methodology	1		
2.0 DESIGN ISSUES AND REQUIREMENTS	1		
2.1 Site Selection and Site Planning Requirements	1		
2.2 First Lunar Outpost Requirements	1		
2.2.1 Lander	1		
2.2.2 Crew Module or Habitat	1		
2.2.2.1 Airlock	2		
2.2.2.2 Safe Haven	3		
2.2.2.3 Command and Communications Center	3		
2.2.2.4 Mission Operations Workstations	3		
2.2.2.5 Health Maintenance Facility	3		
2.2.2.6 Exercise Facility	3		
2.2.2.7 Galley/Wardroom	3		
2.2.2.8 Sleeping Quarters	3		
2.2.2.9 Personal Hygiene Facility	3		
2.2.2.10 Trash Management Facility	3		
2.2.2.11 Logistics-Stowage Area	4		
2.2.3 Astronomy Telescopes	4		
2.2.4 In-Situ Resource Utilization Demonstration Unit	4		
2.2.5 Additional Cargo Landers/Pressurized Research Laboratories	4		
2.2.6 Furnishings and Equipment: General Human Factors Requirements	5		
2.3 Initial Operating Configuration Design Requirements	5		
2.3.1 Quantitative Spatial Requirements for all Functional Areas	6		
2.3.2 Design Requirements for all Functions and Activities	6		
2.3.2.1 Research Activities	6		
2.3.2.2 Command and Communications	6		
2.3.2.3 Crew Functions	7		
2.3.2.3.1 Sleeping and Privacy	7		
2.3.2.3.2 Personal Hygiene	7		
2.3.2.4 Crew Support Activities	7		
2.3.2.4.1 Eating and Meeting	7		
2.3.2.4.2 Food Preparation	8		
2.3.2.4.3 Recreation	8		
2.3.2.4.4 Exercise Countermeasures	8		
2.3.2.4.5 Limited Hygiene Facility	8		
2.3.2.4.6 Laundry	8		
2.3.2.5 Ingress and Egress	8		
2.3.2.5.1 EVA/IVA Movement	9		
2.3.2.5.2 Suit Stowage	9		
2.3.2.5.3 Suit Maintenance	9		
2.3.2.5.4 Suit Donning and Doffing	9		
2.4 Interior Design Components	9		
2.4.1 Computer System and Workstations	9		
2.4.1.1 Computer System	9		
2.4.1.1.1 Information Systems	10		
2.4.1.1.2 Human Factors Issues	10		
2.4.1.1.3 Needed Functions for a Lunar Base	11		
2.4.1.1.4 Additional Functions for a Lunar Base	12		
2.4.1.2.4 Control Locations	14		
2.4.2 Furnishings and Equipment	15		
2.4.2.1 Rack Components	15		
2.4.2.2 Requirements for all Functional Areas	15		
2.4.3 Materials, Colors and Finishes	15		
2.4.4 Illumination	16		
2.4.4.1 General Illumination Requirements	17		
2.4.4.2 Human Factors Requirements	18		

2.5 Building System Requirements	18	5.0 DOMUS I: PROPOSED LUNAR HABITAT AND RESEARCH FACILITY	38
2.5.1 Materials	18		
2.5.2 Construction System	18		
2.5.3 Structural System	19		
2.5.4 Connections	19	5.1 Master Plan and Construction Sequencing	38
2.5.5 Hazard Shielding	19	5.1.1 First Lunar Outpost (FLO)	38
2.5.6 Energy Considerations	19	5.1.2 Intermediate Phases	38
2.5.7 Construction Sequencing	20	5.1.3 Initial Operating Configuration (IOC)	40
2.5.8 Expandability and Retrofit	20		
3.0 DESIGN CONCEPTS: PROPOSALS FOR LUNAR BASES	23	5.2 Initial Operating Configuration	40
		5.2.1 Design Organization of the Habitat/Research Facility	40
3.1 General Technology Design Concepts	23	5.2.2 Building System	41
3.1.1 Membrane Structures	23	5.2.2.1 Materials	41
3.1.2 Tents and Screens	24	5.2.2.2 Construction System	42
3.1.3 Laminated Bladder System	24	5.2.2.3 Structural System	42
3.1.4 Resin Foam-Rigidized Structures	24	5.2.2.4 Shielding	43
3.1.5 Common Module Concept	25	5.2.3 Technical Systems	43
		5.2.3.1 Computer System	43
3.2 Architectural Design Concepts	25	5.2.3.2 Rack Components	43
3.2.1 Inflatable and Hard Module Concept	26	5.2.3.3 Workstations	44
3.2.2 Hard Module Partial Gravity Study	26	5.2.3.4 Furnishings and Equipment	45
3.2.3 Pillow-Shaped Tensile Structure	29	5.2.3.5 Interior Materials, Colors, and Finishes	47
3.2.4 Hard Module Concept — MALEO: Modular Assembly in Low Earth Orbit	29	5.2.3.6 General Illumination	47
3.2.5 Suspended Inflatable Structure	30	5.2.4 Entrance/EVA Modules	48
3.2.6 Earth-Sheltered Family Home	30	5.2.5 Torus: Research Laboratories and Mission Control	49
3.2.7 Hard-Module Rack Concept	30	5.2.5.1 Research Laboratories	50
3.2.8 Underground Hard-Module Linear Concept	31	5.2.5.1.1 Human Sciences Crescent	50
3.2.9 Hybrid Triangular Inflatable/Hard-Module Design	31	5.2.5.1.2 Physical Sciences Crescent	51
3.2.10 Hybrid Underground Design	31	5.2.5.2 Mission Control	52
3.2.11 Martian Inflatable and Hard-Module Concept	32	5.2.5.2.1 Command and Communications Center	52
3.2.12 Pressurized Self-Supporting Membrane Structure	32	5.2.5.2.2 Telerobotics Workstations	52
3.2.13 Rigid Dome Structure	34	5.2.5.2.3 Suit Stowage and Maintenance	52
		5.2.6 Domed Interior of the Ellipsoid	53
4.0 SITE SELECTION	35	5.2.6.1 Crew Quarters	53
		5.2.6.1.1 Entry Sequence	53
		5.2.6.1.2 Single Compartment	54
		5.2.6.1.3 Double Compartment	54
		5.2.6.1.4 Hygiene Facilities	54
		5.2.6.2 Crew Support Facility	54
		5.2.6.2.1 Bounding Platforms	55
		5.2.6.2.2 Wardroom	55

5.2.6.2.3 Library	56	7.3 Major Strengths and Limitations of Domus	71
5.2.6.2.3 Galley	56	7.4 Major Strengths and Limitations of Dymaxion	71
5.2.6.2.4 Recreation	56	7.5 Future Research and Design Development	72
5.2.6.2.5 Exercise Facility	58		
5.2.6.2.6 Limited Hygiene Facility	59		
6.0 DYMATION PROPOSED LUNAR HABITAT AND RESEARCH FACILITY60		REFERENCES	74
6.1 Master Plan	60		
6.2 Construction Sequence	60		
6.2.1 Telerobotic Pre-Flo	60		
6.2.2 Telerobotic Shielding Phase	61		
6.2.3 Continued Crewed Construction	63		
6.3 Interior Components and Dimensions	63		
6.3.1 Research Laboratories	63		
6.3.2 Mission Control	64		
6.3.3 Habitation Inflatable	64		
6.3.3.1 Crew Quarters	66		
6.3.3.2 Crew Support	66		
6.4 Critical Design Features of Dymaxion	67		
6.4.1 Shielding	67		
6.4.2 Packaging	68		
6.4.3. Zoning	68		
6.4.4. Multi-functioning	68		
6.4.5. Variety of Spaces	68		
6.4.6. Interior Spaces	68		
6.4.7. Additional	68		
6.5 Quantitative Volumetric Dimensions of Dymaxion	69		
6.5.1 Laboratories	69		
6.5.2 Mission Control	69		
6.5.3 Crew Quarters	69		
6.5.4 Crew Support	69		
6.5.5 Service	69		
7.0 SUMMARY AND CONCLUSIONS70			
7.1 Critical Design Features of Domus	70		
7.2 Critical Design Features of Dymaxion	70		

1.0 OBJECTIVES AND PROCEDURE

The University of Wisconsin-Milwaukee School of Architecture and Urban Planning (SARUP) and its NASA/USRA ADP strives annually to contribute to a currently-evaluated program at NASA. With the Johnson Space Center as our mentor division, we are afforded the opportunity to consult with engineers, architects and technical personnel establishing criteria for future exploration projects. A continuing area of research and evaluation is the conceptualization and ultimate implementation of a lunar base. A final decision and design have as yet to be determined. Open to a wide variety of conceptual suggestions, NASA looks to internal ideas as well as those from industry and academia. At this starting point, UW-Milwaukee and the SARUP hope to make an impact. Students play the pivotal role participating in an educational process resulting in aerospace design.

The program strives to integrate architecture, engineering, planning, human factors, environment-behavior studies, natural resource utilization, and advanced construction technology.

1.1 OBJECTIVES OF LUNAR BASE PROPOSALS

In the broadest sense, the priority of a lunar base proposal is to provide a safe, productive environment to sustain human habitation and experimentation. To achieve this end, materials should be of near-term technology requiring minimal extravehicular activity (EVA) time for crewmembers. A lunar base represents humankind's ability to expand its own horizons, challenges technology that currently exists, and pushes that same technology to address unique situations. There is potential, as has been demonstrated by shuttle missions, of utilizing new advances to better life on Earth. Also, many feel that within the first decade of the new century, the goal of achieving a permanent settlement on another celestial body is within reach.

In addition to the construction of living and working environments for the astronauts, the following requirements detail the goals for extraterrestrial habitation:

- habitation supporting a crew of 12 international astronauts
- utilization of a First Lunar Outpost (FLO) as a commencement point for construction of the permanent facility

- addressing psychological and sociological issues related to long-term isolation and confinement
- construction technology exhibiting advancements in material design, weight reductions and compactability for transport
- advancing scientific knowledge with on-site laboratories and human participation
- studying effects of a lesser gravitational field, and protective measures against temperature extremes, environmental vacuum, and radiation hazards

1.2 PROJECT GOALS

The specific goals for this current ADP project included the aforementioned list. Attention was directed toward a permanent lunar base for an international crew of 12, providing laboratory facilities to support investigation in plant growth, microbiology, life sciences, health maintenance, physical sciences, geomorphology and telerobotics. To specifically support the crewmembers, areas to sleep and perform personal hygiene would be designed. Areas supporting activities such as eating, food preparation, recreation, exercise and social interaction would also be addressed in the design.

1.3 DESIGN METHODOLOGY

Background investigation was an integral component of the semester ADP. The approach began by a comparative analysis of numerous lunar base proposals and construction methods. The relative strengths and weaknesses were evaluated according to ease of construction, simplicity of design, near-term technology, volumetric allowances for specific functions, EVA involvement, and number of facility components.

By process of elimination, proposals that appeared most favorable were investigated further. One proposal and one construction method fulfilled the criteria and were selected for a feasibility study. The result were two parallel studies for design consideration.

Consistent throughout the semester were design reviews and critiques. The bulk of the design work was completed using AutoCAD. The resulting final product was a complete lunar base facility, supporting habitation and scientific functions.

One study was delivered as a complete AutoCAD slide program, rendered in Animator-Pro and 3-D Studio programs. An animated fly-through provided a brief overall perspective of the base exterior and interior components. The second parallel study was delivered using only AutoCAD drawings without animation.

2.0 DESIGN ISSUES AND REQUIREMENTS

2.1 SITE SELECTION AND SITE PLANNING REQUIREMENTS

The site for any future lunar base will be chosen in response to two considerations. The most important requirement is that the site support scientific research. Local minerals, optimal location for telescopes and communication systems will support scientific placement. It is assumed that precursor missions will have investigated the surface of the Moon, aided in locating the optimal site, and use past Apollo missions to further determine the First Lunar Outpost (FLO) location. The second consideration is that a predesigned base configuration can be successfully implemented. We will need to be familiar with the local topography and use that knowledge to either deliver existing equipment to the surface, or design machinery that will respond to the exceptional environmental conditions. Construction methodology will follow a similar pathway.

There will be four major elements to the base: the solar panel collection fields, nuclear power facility, the habitat, and the launch and landing site. Permanent landing pads should be located between 3 and 5 km from the habitation zone, and no further than 5 km away from FLO. The base should have a north-south axis, the habitat centrally located within this axis, with the power and landing areas on opposite ends of the axis. This will allow a protective envelope for the habitat guarding against spacecraft fly-over and potential hazard. The nuclear power facility should be located 1 km from the habitat, accessible by road along the axis. This allows for a measure of safety while limiting the distance current must travel. The solar fields should be located where little exploration is expected, limiting dust contamination. Future field operations and lunar scenery should be taken into consideration.

2.2 FIRST LUNAR OUTPOST REQUIREMENTS

According to the latest NASA thinking and requirements (Carpenter, 1992; Perkinson, Adams, et. al., 1992), FLO will consist of the following components:

- lander
- crew module or habitat

- astronomy telescopes
- in-situ resource utilization demonstration unit
- additional cargo landers/research laboratories
- integral rovers
- furnishings and equipment

The lander, crew module, and return stage should remain functional for return to Earth from the Moon. The requirements for each of these components will be covered briefly in the following sections.

2.2.1 LANDER

The lander should provide the capability to deliver 5 mt (E) of cargo and a nominal crew of four from lunar transfer orbit to the lunar surface. This is an estimate of the resupply and science equipment mass needed to support the nominal mission specified for revisit to an established lunar outpost.

2.2.2 CREW MODULE OR HABITAT

The crew module should be able to be depressurized while the crew is living in the surface habitat. Given a limited number of repressurizations, the requirement to provide ingress/egress between the piloted crew module and the lander is best met by depressurizing the entire crew module rather than providing an airlock. The current NASA working assumption is that it is cheaper to require the return vehicle to remain functional when depressurized than to repressurize the crew module following egress.

General requirements for the crew module/habitat include the following:

- the architecture should be configured to accommodate evolution of the outpost, e.g., potential additional volumes include airlocks, logistics containers, other habitats, etc.; growth should accommodate spatial adjacency between similar activity centers and not jeopardize crew well-being
- the architecture should be designed for simple interfaces, modularity, and replacement; this modularity should provide quick disconnect for hardware and electrical equipment

- the habitation volume should allow future integration of an additional pressurized volume to provide for outpost expansion
- to overcome the stresses induced by the mission environment, “mental health is preserved by providing: appropriate design, appropriate crew selection, training, and psychological support”
- the concepts for the habitat should not be limited to currently available or designed hardware, and should include options utilizing pressure-stabilized structures
- internal access to the pressure shell of the habitat shall be provided within 30 minutes of a warning, to allow sealing of leaks, rerouting of wiring, removal of dust, etc.
- the architectural layout should insure that adjacent volumes are set aside for similar or compatible activities and that interfering activities be separated, e.g., compatible activities such as hygiene and waste management functions can be adjacent, while interfering activities such as food preparation and waste management should be separated
- the architecture should provide a marked emergency route for contingency operations
- the habitat should support internal operations by space-suited crewmembers, e.g., emergency cases will require suited crewmembers to operate inside habitable elements
- the architecture should accommodate unimpeded translation and circulation paths within the habitat; traffic paths should be sized according to activities, location of crew stations, and size of cargo/crew; a range of scenarios focusing on the equipment size and crew moving through the habitat need to be addressed
- the intra-vehicular activity (IVA) architecture of the habitat shall provide a minimum of 10.0 cubic meters of habitable volume per crewmember (by habitable volume is meant free volume that the crew can access for working, sleeping, eating, personal hygiene, recreation, exercise, etc.)
- external viewing shall be provided for the crew; windows or video are essential for crew use in observing their external environment
- the architecture should provide multipurpose/flexible activity centers and volumes; multipurpose utilization will increase the efficiency of the habitat, e.g., the wardroom can fold away to create an open area for exercise equipment

- the architecture should provide a consistent orientation throughout the habitat, to provide a familiar and comfortable living and working environment for the crew
- the habitat shall provide two independent paths for crew egress; in the event of fire or other emergency which may block crew access to the airlock, an emergency exit (hatch) must be provided for crew egress

2.2.2.1 Airlock

Airlocks function as a dust-off, pressurization, and ingress/egress point for the crew to transfer between the lunar surface and the habitat. While crew ingress/egress is the primary function of the airlock, lunar dust is both very fine and abrasive, potentially causing medical problems for the crew and impairing the operations of habitation systems, and must be removed before entry. Specific requirements include the following:

- the airlock must isolate the two environments: EVA and IVA
- the airlock shall provide transitions between pressurized and unpressurized environments
- the airlock also provides a space for dust and contamination clean-up before entering the habitat; a method for removing dust from the airlock shall also be provided
- the airlock shall also provide the capability for cargo ingress and egress for retrofitting, resupply, maintenance, or repair, e.g., habitat laboratory equipment, consumables, sample containers, maintenance equipment, EVA suits, and logistic replacement units
- the airlock shall provide the capability to accommodate ingress/egress of an injured crewmember wearing a spacesuit, i.e., a hatch size no less than 2 m vertical by 1 m horizontal for a vertically-mounted hatch, or 1.4 m by 1.4 m for a hatch mounted 45 degrees from horizontal
- the airlock should have sufficient room for two crewmembers to don/doff suits by themselves or aided by a third crewmember
- all hatches shall be operable from either side by pressure-control valves by a suited crewmember without the use of tools
- the airlock should be able to function as a hyperbaric chamber with sufficient high-pressure oxygen and nitrogen bottles

2.2.2.2 Safe Haven

A “safe haven” is a desirable into which to retreat in case of a fire or other hazard. The use of an airlock is possible, but has not yet been fully evaluated by NASA (D. Perkinson in Carpenter, 1992).

2.2.2.3 Command and Communications Center

There shall be a centralized command and communications center to serve as a Base Command Center and as the Earth Communications Center.

2.2.2.4 Mission Operations Workstations

At the present time (Carpenter, 1992), it is expected that the primary mission operations for a First Lunar Outpost will consist of four research functions:

- space physics
- engineering research
- life sciences
- geosciences

In all phases of the mission, the crew will be interacting with various workstations. Designing these stations around crew capability maximizes productivity (Brown & Bond in Carpenter, 1992). Crew size, and therefore viewpoint, reach, and restraint should be considered. The gravity environment, required visual data, room to use tools and equipment, and location of task should be considered to maximize crew capability.

2.2.2.5 Health Maintenance Facility

Capability for emergency surgery and critical care shall be provided at the lunar outpost, including evaluation and treatment of significant, normally survivable injury and illness including dental care with standard immediate and ongoing care (cf. Brown/Waligora v Petri in Carpenter, 1992). The Health Maintenance Facility shall provide space for clinical medical procedures and storage of clinical medical equipment and supplies. The habitat shall also provide the capability to monitor crew health and physical conditioning.

2.2.2.6 Exercise Facility

Programmed exercise on exercise devices shall be provided as a countermeasure to loss of muscle mass and as a possible countermeasure against loss of bone mass and other physiological consequences of reduced gravity.

2.2.2.7 Galley/Wardroom

The galley/wardroom will serve for all eating, meetings, and passive recreation. The following requirements apply:

- capability to store food, including environmental control (e.g., refrigerator and/or freezer), for 4 crewmembers for 45 day stays
- capability to provide warm food products, the type of heating to be dependent on gravity environment, cabin pressure, and food packaging material

2.2.2.8 Sleeping Quarters

The habitat element shall provide crew sleeping accommodations to maintain the health, safety, and productivity of the crew.

2.2.2.9 Personal Hygiene Facility

The capability for personal hygiene shall be provided to the crew for improved productivity, prevention of skin diseases, reduction of transmission of harmful microorganisms, removal of debris, and control of body odor. This facility should provide for hair grooming, skin care, body deodorizing, nail care, brushing teeth, and hair removal, including cleaning the body post-urination/defecation, post-exercise, during medical/health maintenance, pre/post meals, and pre/post experimentation or other work requiring specialized washing. At a minimum, this should include a toilet and lavatory (the provision for a shower for 4 crew, 45-day missions is being debated; cf. Petri v Brown/Bond in Carpenter, 1992).

2.2.2.10 Trash Management Facility

Other habitat hygiene includes housekeeping activities which include dust removal, clean-up following meals, and waste management/disposal.

A method and space shall be provided for preparing trash for disposal by packaging, compaction, and/or recycling. It is estimated that a 4-person crew for a 45-day stay will consume over a ton (English) of matter (ca. 25 cu m) per 45 days, all of which becomes trash except for small quantities of water and carbon dioxide (Perkinson in Carpenter, 1992). This volume cannot remain inside any habitat and so must be disposed of or recycled in some way, such as being used for radiation shielding.

2.2.2.11 Logistics-Stowage Area

Consumables (oxygen, nitrogen, water, food, refrigerated/frozen food, etc.) and equipment (suits, tools, filter, scientific equipment, spare parts, seals, etc.) required to support lunar surface activities and the crew during a nominal lunar surface mission must be able to be stored and replenished.

Storage must also be provided for 200 kg of geologic and biomedical samples (including containers) for transfer to the crew module and return to Earth, including space to package and pack these samples.

An organized and accessible stowage system shall be provided that accommodated stowage of all look equipment including scientific instruments assigned to the mission. Such a stowage system shall include well-defined and logically packed system of lockers, drawers, trays and appropriate retention and packaging accommodations. Stowage volumes shall be standardized and modular throughout the habitat to accommodate logistics resupply of items and packages of various sizes and shapes. Such a system shall withstand environments from micro-g to hyper-g.

2.2.3 ASTRONOMY TELESCOPES

At the present time (Carpenter, 1992), it is expected that the total FLO environment will include three astronomy telescopes for space physics and astronomy situated sufficiently far from FLO to be protected from launch/landing blast-off and debris and yet close enough for EVA deployment and operation.

A Lunar Ultraviolet Transit Telescope (LUTT) will have an approximate mass of 200 kg, require an approximate power of 100 watts, occupy an approximate packed volume of 2.7 cu m, and have an approximate data transmission rate of 200 kilobits per second (Eppler in Carpenter, 1992).

A Small Research Telescope (SRT) will have an approximate mass of

200 kg, require an approximate power of 500 watts, will occupy an approximate packed volume of 2.5 cu m, and have an approximate data transmission rate of 100 kilobits per second (Eppler in Carpenter, 1992).

A Small Solar Telescope (SST) will have an approximate mass of 100 kg, require an approximate power of 50 watts, will occupy an approximate packed volume of 1 cu m, and have an approximate data transmission rate of 256 megabits per second (Eppler in Carpenter, 1992).

2.2.4 IN-SITU RESOURCE UTILIZATION DEMONSTRATION UNIT

To conduct in-situ resource utilization (ISRU) surface operations, an ISRU demonstration unit will be deployed and set up by a two-person crew to a position near the side of the habitat within power cord reach of a power connection to the habitat. It will require active participation by the crew to load samples and recover materials more convenient to the crew and eliminates the need for an additional power supply.

The geosciences research function shall support this unit by delineating lunar resources local to the outpost, operating the resource utilization projects, and test the use of space resource utilization products.

The ISRU demo package will have an approximate 750 kg, require an approximate peak power of 2900 watts, and occupy an approximate packed volume of 0.6 cu m (Eppler in Carpenter, 1992).

2.2.5 ADDITIONAL CARGO LANDERS/PRESSURIZED RESEARCH LABORATORIES

Provision should be made to unload rovers and science payloads from additional cargo landers on the lunar surface, and to reuse the landers as pressurized research laboratories. Present thinking (Carpenter, 1992) is that in addition to the astronomy telescopes and ISRU demonstration unit there will be three pressurized remote laboratories in proximity to the lander/habitat:

- engineering research laboratory - for engineering tests on the lunar surface, evaluation of subsystems and prototypes of future equipment, and demonstration of prototypes for future lunar surface processes

- life sciences laboratory - for life sciences research on the lunar surface including acquisition of samples, for IVA life sciences research relating to human parameters including the monitoring of human performance and biomedical parameters, and for operating experiments in human physiology, exobiology, and gravitational biology
- geosciences laboratory - for initiating and conducting environmental characterization and regional exploration of the lunar surface, monitoring geophysical activity (including remote monitors of an approximate mass of 216 kg and approximate packed volume of 0.5 cu m and other geologic field equipment of approximate mass of 336 kg and approximate packed volume of 1.8 cu m), support a team of two astronauts for geologic and geophysical EVAs, space for geoscience instruments and analysis including basic composition and description of lunar materials, sample identification, and sorting (ca. 200 kg for return to Earth)

2.2.6 FURNISHINGS AND EQUIPMENT: GENERAL HUMAN FACTORS REQUIREMENTS

- all equipment shall accommodate crew size and reach, including visual cones and eye points, switch positions, and reach envelopes for 5% American female to 95% American male
- items shall be stowed adjacent/near the area where they are to be used
- IVA furnishings shall be reconfigurable for temporary stowage when not in use (e.g., wardroom seating and table when not in use to provide a larger volume for other uses, e.g., for exercise)
- IVA furnishings shall be reconfigurable to accommodate a range a crew sizes (e.g., partial gravity seats should have seat height, angle, etc. adjustments just like a 1-g chair)
- IVA furnishings shall be provided that optimize partial-g human postures (predicted to be somewhere between 1-g and 0-g normal postures; Carpenter, 1992)
- living and working furnishings such as sitting, sleeping, working, and eating accommodations shall be provided, with consideration given to the partial-g aspect of each item - trade studies shall insure that partial-g implications for each such device have been addressed in its design

- the crew module shall provide crew couches to support the crew during prelaunch, launch, partial-g, and hyper-g phases
- the IVA architecture shall provide a location coding system that is consistent throughout the crew module
- The IVA architecture shall provide translation non-slip surfaces with a friction co-efficient of 1 or better (Brown/Bond in Carpenter, 1992)
- lighting levels shall be tailored for designated operation to allow either direct visual viewing by crew members or indirect viewing by monitoring devices such as cameras
- the IVA architecture shall provide mobility aids and restraints/handholds within the habitat (preliminary observations from lunar partial-g testing (cf. Brown/Bond in Carpenter, 1992) indicate that translation devices may be required; the control or lack of control during translation may be dependent on physiological degradation, mission workload, nutrition, rest, and sleep; trade studies of prolonged exposure to partial gravity and its effects on human performance require further examination; for example, access to ceiling compartments may be easy at the beginning of a mission, but as the body adapts or degrades to partial-g, crew members may require a stool or platform to access overhead stowage; similarly reaction aids may be required if sufficient force cannot be generated to move or open objects in the partial-g environment (Brown/Bond in Carpenter, 1992)

2.3 INITIAL OPERATING CONFIGURATION DESIGN REQUIREMENTS

Spatial and volumetric requirements for functions within the lunar habitat should be based upon a variety of factors. For example, critical will be the weight at liftoff. Those restrictions are then applied resulting in space allotted for science and experimentation, crew support and housing, maintenance and logistics. These should reflect habitability and behavioral issues related to the human response to isolation and confinement: sleep, exercise, medical support, personal hygiene, food preparation, group interaction, habitat aesthetics, communications, recreation, privacy and personal space, and waste disposal and management (Stuster, 1987). Mission directives will streamline the technical necessities, further sophisticating the profile of the base concept.

2.3.1 QUANTITATIVE SPATIAL REQUIREMENTS FOR ALL FUNCTIONAL AREAS

The commencement point for the determination of appropriate volumetric sizing is the human form. Architectural Graphic Standards (Ramsey & Sheper, 1989) directs the use of 97th percentile values to determine space envelopes, 2.5 percentile values for the maximum "kinetospheres" (reach areas by hand or foot) and the 50th percentile values for control and display heights. This numerical data must then be augmented by the change in body alignment resulting from the gravitational delta. This is adjusted to reflect unusual requirements in the body envelope as a result of necessary attire, e.g., translation in corridors with a crewmember fully space-suited. The body envelope dimensioning can be applied to each specified function within the habitat. Final sizing requirements and recommendations can then be evaluated against other sets of recommendations.

It should be noted that there is a lack of hard empirical data to support the recommendations of the suggested volumetrics at this point in time. These values are suggestions that will be altered and augmented as the time approaches to commence the construction of the lunar base.

2.3.2 DESIGN REQUIREMENTS FOR ALL FUNCTIONS AND ACTIVITIES

2.3.2.1 Research Activities

Any science-related discipline requires research laboratories. This portion of the lunar base should be designed for a 24-hour per day mission schedule. There should be adequate circulation within and amongst the laboratory workstations. The science area must address not only physical, but human sciences as well.

Every laboratory on Earth has its own specific set of requirements for equipment, method of examination and testing, sample stowage and retrieval, and communication and delivery of physical experiments to outside locations. To design one generic laboratory suitable for all disciplines is not practical. As the space community determines which of the scientific areas will be included in future lunar bases, specific sets of requirements will be drawn. Certain functional spaces that serve all labs can be determined and included now:

- working and counter space

- stowage
- easy accessibility to all equipment
- furnishings responding to 1/6-g anthropometrics
- functional circulation pattern
- acoustic control and abatement
- ventilation
- water supply

The following are a sampling of the suggested areas of research that have been considered for future use: microbiology — a subdivision of biological research that addresses the research of microscopic forms of life; life sciences — to study the physiological effects of reduced gravity and the psychological implications of isolated and confined living; health maintenance — a medical facility to monitor and attend to the physical condition of each crewmember; physical sciences - studies will be conducted on nonliving materials; geomorphology — investigation of the surface and subterranean relief features of the Moon, then interpreting the features genetically; botany and plant growth — a subset of biology, this area examines the potential of growing plants in new environments; telerobotics — this research will focus on using robotics to aid in surface operations, alleviating unnecessary EVA time for the crewmembers.

2.3.2.2 Command and Communications

The general requirements needed to be met for command and communications are the following:

- ability to operate all vital function on the lunar base
- backup systems available
- manual override available
- interconnection to all other base terminals
- communications access
- compatible to other systems

By meeting these general requirements, command and communications will not only serve as the main control area, but also function to serve other needs of the crewmembers within the lunar base.

2.3.2.3 Crew Functions

Crew quarters are essential in providing the crew privacy, a place for retreat, and additional personalization necessities. The quarters must be equipped with a hygiene facility and sleeping quarters to accommodate 12 crewmembers. The goal is to provide a comfortable and functional atmosphere while addressing both lunar and Earth requirements:

- crew quarters should include a horizontal sleeping space
- should provide an area for face, hand, eye and body wash
- provide controls for communications and caution/warning system
- should provide a personal work space
- provide stowage for personal belongings
- should utilize hand holds for translation

2.3.2.3.1 Sleeping and Privacy

Single and double crew quarters should consist of full habitat accommodations for each crewmember. Single crew accommodations will provide maximum privacy; double quarters will provide space for two crewmembers. The selection of which crewmembers will occupy the single/double quarters will be based upon the crew selection process, while allowing a crewmember a measure of personal choice. Each quarter, both single and double should contain:

- controls for communications and caution/warning system
- personal work space
- personal stowage compartments
- horizontal sleeping space (bed)
- accessibility to hygiene facility

2.3.2.3.2 Personal Hygiene

The crewmembers will require facilities to accommodate full body cleansing, and should consider waste management as well. Each facility should include:

- hand, face, eye cleansing capability
- toilet

- shower and full body cleansing
- mirror
- stowage for general supplies
- ventilation for humidity control
- adequate volume to allow donning and doffing of clothing, drying off after shower
- lighting system for proper visual acuity for personal hygiene

2.3.2.4 Crew Support Activities

An integral function of the lunar missions will be the ability to relax and socialize with fellow crewmembers. An area must be dedicated to allow for the entire crew or just a portion of the crew to gather, prepare food, eat, rest, read, watch video productions, listen to music, or exercise.

2.3.2.4.1 Eating and Meeting

The wardroom will be promoted as a gathering arena for the crew. The volumetric requirements should contain adequate space for 12 crewmembers to be seated and conduct briefings as well as celebrations. This space should also be conducive to sharing meals. Requirements should include:

- seating for 12 persons
- table accommodating 12, yet can be reconfigured to seat fewer numbers, especially 6 at one time
- communication system for teleconferencing
- lighting to allow for task and general illumination
- materials to permit easy maintenance and cleaning

2.3.2.4.2 Food Preparation

A galley should be provided to function not only as a space for food preparing, but also for stowage of consumables, cleanup post-mealtime, and for waste management. This volume should allow for more than one crewmember to prepare food. Included in the galley should be:

- food stowage compartments

- refrigerator/freezer
- microwave/convection oven
- food preparation equipment
- food consumption utensils
- sink
- trash management container
- cleanup supplies
- material surfaces conducive to easy maintenance
- illumination for tasks and general activity

2.3.2.4.3 Recreation

This area should be dedicated to crew relaxation and communication, not only within the base, but with Earth as well. Many of the activities the crew will perform for relaxation can take advantage of dual-functioning spaces. Included should be:

- audio/visual projection system
- stowage compartments for video or audio tapes, compact discs
- seating for smaller groups of crew members
- seating to accommodate quiet activity e.g., reading
- space reserved for game playing
- space allotted for small group casual conversation
- stowage for hard-copy printed books for leisure

2.3.2.4.4 Exercise Countermeasures

Due to the physical degradation of the human in a lesser gravity field, exercise will be an important portion of the daily routine. To promote the use of exercise equipment and to make the rigors of physical activity a more enjoyable experience, it is suggested that the area dedicated to exercise be closely associated with group gathering:

- space should be allocated to furnish at least two dual-function machines
- machines should be compactable to allow for closure and stowage during nonuse periods

- provide visual stimulation with the use of audio/visual projections, scenic pathways, or Earth-based panoramas
- provide personal hygiene function with limited hygiene facility

2.3.2.4.5 Limited Hygiene Facility

This facility should provide limited functions of quick cleanup post-exercise, and the placement of this facility should be adjacent to the exercise area. Included in the functions should be:

- toilet
- handwashing and facewashing area
- mirror
- stowage compartment for general supplies

2.3.2.4.6 Laundry

The cleaning and maintenance of personal clothing, bedding, etc. may be accomplished pending the invention of a satisfactory method of accomplishing the task in 1/6-g. At present, one particular method has not been defined. The laundry should be adjacent to other functional areas of crew support requiring similar components e.g., water or power. Requirements for a laundry facility should include:

- washer and dryer
- stowage for supplies
- surface for sorting or folding of clothing

2.3.2.5 Ingress and Egress

Airlocks will provide efficient ingress/egress of the habitat. Dust suppression devices will be used to prevent contamination of the habitat and laboratories. It will be necessary for the airlock to have the capacity to dual function.

2.3.2.5.1 EVA/IVA Movement

For the ease of translation from the interior environment of the habitat to the exterior surface of the Moon, the following should be considered:

- use a close surface access point as a safe haven
- permit equipment transfer through the airlock to the habitation area
- entry or exit of the habitat without having to depressurize or reduce the normal internal operating pressure
- provide smaller chamber for complete depressurization
- provide dust-off capability at the entrance to the airlock
- support EVA operations, e.g. tools, equipment stowage, power supply
- allow crew transfer from the lander to the habitation module
- serve as a hyperbaric chamber and contain hyperbaric equipment
- dust exclusion from habitation area from lunar surface operation

2.3.2.5.2 Suit Stowage

Each crewmember will need to have a separate EMU, with the availability to reach that suit quickly in the event of a failure within the habitat. Suits should be stowed as separate pieces, readily accessible for each crewmember. Additional considerations are:

- provide stowage facilities for suits
- provide compartments for additional suit parts, e.g., gloves, visors, and boots

2.3.2.5.3 Suit Maintenance

The EMU will need servicing each time it is used on the surface or in the event of an emergency. To maintain the suit, space must be allocated for repair and cleaning, power regeneration, or replacement of damaged portions. Requirements that should be addressed are:

- work surface to physical handling of the EMU
- supply of power for regeneration of life support system
- stowage or hanging capability for the suit as a unit
- stowage for tools and equipment necessary for maintenance
- illumination provided for task or general activity
- stowage for additional EMU spare parts

2.3.2.5.4 Suit Donning and Doffing

Each crewmember must have physical volume to put on and take off an EMU. The suit is bulky and may require the assistance of a fellow crewmember. Ease of donning is required in the event of an emergency, and the space allotted for this function must permit this activity. Required is:

- sufficient volume for donning and doffing EMU
- hand holds to provide support

2.4 INTERIOR DESIGN COMPONENTS

2.4.1 COMPUTER SYSTEM AND WORKSTATIONS

At the heart of the lunar base lies the central processing unit. Without its use, monitoring all the environmental controls and other needed functions would be extremely difficult. The computer must supply all the vital needs for the lunar base, and it must be able to fit into a standard rack or workstation. Computer systems needs to be analyzed to determine what type computer system is to be used. Then the workstation should be designed around the computer system for ease of use and reparability.

2.4.1.1 Computer System

Before a workstation in a lunar base is designed, it is essential to know the physical size of the processing unit, monitors, printers, disk drives, and discrete components which will be used within the workstation design. Determining the size of the computer system requires a knowledge of the internal and external working of the computer. Some of the issues that need to be addressed are:

- information systems
- human factors issues and computers
- functions needed for the lunar base
- additional functions required by the computer system

2.4.1.1.1 Information Systems

Laudon & Laudon (1991) state the formal definition of information system is the set of components working together to collect, retrieve, process, store, and disseminate information for the purpose of facilitating planning, control, coordination, and decision making . The basic components that make up an information system are the following:

- input
- processing
- output
- feedback

For the lunar base, the following devices should be used to satisfy these needs:

- satellites
- cables
- monitors
- computers
- hard copies such as books, printouts
- voice messages

NASA makes use of satellites to relay information to and from Earth. The space shuttle uses the orbiting Tracking and Data Relay Satellite (TDRS-1 and TDRS-4) and the Data Relay Network controlled ground stations for communications and information relay to and from the shuttle (Internet, Tracking and Data Relay Satellite System). For the lunar base, it will be assumed that a similar system for input and output to the base from Earth will be utilized.

Cables are used on Earth as well as in space to transmit data across a conducting line. For the lunar base, it is important to know which cables will be used for interconnections so it can be determined how much chaseway space is needed for cables. Tanenbaum (1976) states the RS-232-C cables have a standardized 25-pin connector on them, and the RS-232-C standard defines the size and shape of connector and cable. The RS-422 is another cable being utilized for space application. Note that the cable might need shielding to prevent any stray AC signals that may enter the cable.

Monitors visually show the information to be used by the system. To

save space and cost, flat-screen technology is used; however, since the flat screen provides more distortion than a cathode-ray tube (CRT), CRTs are used to show data which is needed to vital operations. The shuttle uses 12-inch diagonal CRT screens providing a 22-line display (47 characters per line) in three colors (green, red, yellow). In addition to 128 alphanumeric symbols, the unit can display vector graphics (1024 different lengths and 4096 angles). A high intensity green flashing mode is also provided (Internet, Multifunction CRT Display System). The shuttle type CRTs will more than likely be used on the lunar base, but more research is needed to determine what kind of flat screen monitors are to be used.

The computer is the brain which does the processing of information. Based upon shuttle technology, the AP-101S by IBM was selected for all processing. The AP-101S should satisfy the processing needs of the lunar base because of the success of use in the space shuttle. More research is encouraged for a processing unit due to constant technology changes and upgrades. It should be noted that included with the processing unit would be electronic storage by means of RAM, ROM, and external drives.

Hard copies of data may be provided upon request. Laser printers will jet out information which may be to be examined carefully. Utilizing hard copy, corrections can be made by hand and allow an overview of the data.

Lastly voice messages are relayed by using speakers mounted next to the monitors. A small microphone will be enclosed to pick up the operator's voice and transmit it to other parts of the base. Still experimental, the Voice Command System (VCS) is used to control shuttle television cameras with verbal command (Internet, Voice Command System).

2.4.1.1.2 Human Factors Issues

Sanders and McCormick (1987) define human factors as focusing on human beings and their interaction with products, equipment, facilities, and environments used in work and everyday living. Some human factors issues that should be dealt with for the computer system are the following:

- speed
- accuracy
- reliability
- compatibility
- size

Although many other human factors or ergonomics issues could be dealt with, the previous mentioned factors are relevant to the cause.

Speed is the response time of the computer versus the time the user wants to process the information. It will be assumed that the user wants the information to be processed as quickly as possible so that he/she may continue other work. speed may be measured in bits per second, miles per hour or cycles per second. For the computer, hertz and bits per second are the two measures of speed that will be used. Translating this to the computer hardware, the control unit should generate signals fast enough to utilize the bus structure most efficiently and minimize the instruction execution time. Shiva (1991) states the speed of the microprocessor may be enhanced by minimizing the execution time of each instruction or minimizing the execution time of a sequence of instructions. These speed requirements are needed for a fast processor for the lunar base since time may be a matter of life or death.

Accuracy involves the precision to which the calculations have to be made. The more precise the calculations, the more memory and circuitry will be needed to hold significant digits and their calculations. Accuracy may also be applied to how the data actually appears on the computer screen (visual acuity). Accuracy may be measured in terms of bits and/or bytes. It will be assumed that the more bits a computer uses, the greater the amount of information can be processed. For the computer, the ASCII or EBCDIC code is used in which each character is one byte long. Shiva states the maximum length of a character string is a design parameter in a particular machine .

Reliability has much to do with probability and statistics. The computer should be running without failure for an infinite time, without breakdown. Since the study of probability and statistics requires complex mathematics, this topic will not be discussed in detail, but by using machines that have been in existence for several years, the reliability of the machine may be increased. Also, fault checking may be used by the addition of extra hardware. Table 2.4.1.1.2-1 shows techniques in increasing the reliability of the computer by the concept of redundancy.

When a machine needs to be interfaced to the external world, compatibility becomes an issue. Compatibility refers to the ability for the machine to interact with another machine or a transducer of some type. Most computers can be adapted to fit or synchronize with another computer with the addition of interface cards, a change in pin configurations, or a change within the program itself. For the lunar base, the computer should

be able to communicate easily with Earth-based computers and lunar base subsystems.

The physical size of the computer is an issue relevant to allotted space requirements. With the advent of the microchip, the processing units are becoming ever smaller; however, the hardware for the computer to run, including the power supply, will take up physical space. Obviously if the computer system were too small, the crewmember could not input information or read the output from a screen. The size of the computer therefore, will be determined mainly by the components inside, and ;by the input and output needed by the person. For the lunar base, it will be assumed that the hardware is already available; therefore, this factor will be limited for control due to preexisting parts.

2.4.1.1.3 Needed Functions for a Lunar Base

The computer must be able to handle the following lunar base functions:

- pressure control
- telerobotics
- fire suppression
- communications
- health monitors
- future needs

Since the lunar base is pressurized, it is important for the computer to monitor any pressure changes within the habitat, and make the necessary corrections. Pressure control in space is still in the experimental stages with NASA (Internet, 1993).

Telerobotics will be used to do research work, repairs, and explore the land on the outside of the habitat. The computer and workstation should have provisions for controlling the telerobotics from the inside of the base.

If a fire should break out within the habitat, the computer system needs to activate a warning system and take the necessary steps to isolate or extinguish the fire. The fire suppression system will contain Freon-1301 extinguisher bottles for the automatic fire suppression, and the hand-held fire extinguishers will contain Halon-1301 (Internet, 1993). Communications will be utilizing a separate screen to observe the person being spoken to, or use television cameras to monitor activities of the robotics. A closed-circuit TV type system will be installed to monitor activities within each

section of the lunar base. The computer will control the frequencies of communications and what appears on the screen while the interaction is being performed.

Health monitors and related health equipment will be controlled with the central processing unit to insure crew health. Health monitoring equipment would include such items as thermometers, pulse rate machines, diet control machines, exercise monitors, and other necessary equipment to check vital signs. After all the information from a crewmember has been gathered, the computer will process this information, and determine whether the crewmember is healthy.

Lastly, the computer should be able to handle future needs such as expansion of the base or the addition of equipment.

2.4.1.1.4 Additional Functions for a Lunar Base

Additional functions a computer should be equipped to address are the following:

- e-mail
- training
- inventory and management
- caution and warning system
- manual override

E-mail is not a necessity for the system, but it can be utilized to communicate with other users when the communication system may be down. E-mail is simply electronic mail, and it allows the user to type in a message on the computer and send it electronically to another user.

If a crewmember is new to the system, the computer should have a training program installed. This program will teach the basics of the lunar base computer system.

The caution and warning system should contain different types; of sounds and lights to indicate what and where the problem is. Three colors of light, red, yellow and green, are suggested to be used for the base, placed next to doors or protruding from walls to indicate the malfunction. The caution and warning system would advise the user to take the necessary steps to correct the problem and contact an Earth-based station automatically.

If the computer system should fail completely, there should be a manual override for each necessary function. The manual override panel would contain discrete components needed to operate the base until the computer system was repaired.

2.4.1.2 Workstations

To design a workstation, the components that will be placed on the workstation must be analyzed. The workstation can then be designed around the components and made so that a crewmember can easily perform his/her necessary tasks. Some of the issues which will be analyzed for the design include:

- workstation function
- workstation ergonomics
- the purpose
- location of workstation controls

2.4.1.2.1 Purpose

For the lunar base design, four basic workstation design must be analyzed. These four included, the central command center, laboratory units, wall-mounted units, and backup units.

The central command center should contain enough room for three monitors, a keyboard, telerobotic controls, communications, and other discrete switches and displays that may be used. The purpose of the three monitors is to be able to simultaneously interact with the computer, perform telerobotics with a remote camera, and talk to someone or send email messages. It is for practicality that the command center fit within three standard racks. Each rack should contain one monitor and associated controls for functions such as warning systems, fire suppression, and telerobotics.

The laboratory unit should be two standard racks in width. While performing experiments, it is necessary to have a table to write on, a keypad to enter information into the computer, a separate memory and storage device to eliminate the use of the main frame, a printer for raw data and measurements, and a storage place for the hard data and software; therefore, a two-rack system should be used for the laboratory racks. Two types of laboratory units needed to be designed are for areas of possible contamination and areas where there is no contamination. For the former, regular keyboards and components may be used; however, where

contamination is possible, components with minute gaps easily cleaned are necessary.

The backup unit is an extension of the command center. It should consist of two monitors, a standard keyboard, and space for a variety of discrete controls. Two monitors allow the user to simultaneously control the computer and communications in the event of an emergency. The backup center uses components from the rack and is designed to fit into the commander's crewquarters.

Wall-mounted units may be used in the event of emergency. These controls should be mounted upon the walls at various locations, perhaps at safe haven points, to allow the user to communicate with the computer at point locations.

2.4.1.2.3 Workstation Ergonomics

Human factors issues to be dealt with in the design of a workstation are the following:

- gravity of the environment
- user population
- movement
- musculoskeletal tension

The gravity level deals with the physical dimension and layout of the workstation to conform to a particular user in a g-level which the station is being used. For example, the body posture is different at 1-g rather than at 5-g.

The workstation should be designed to conform to the characteristics of a specific population of users for whom the system is designed. The station should be design to fit the anthropometric range of the lunar base crew.

Workstations should be configured so that body movement, when operating the controls is kept at a minimum. As well, priority and time movement will determine the location of certain functions within the workstation.

The workstation should be designed to minimize the musculoskeletal tension required to maintain a posture or position required for a particular operation.

2.4.1.2.4 Control Locations

The controls of the workstations include everything needed to provide electronic information to and from the computers, cameras, and sensors both inside and outside of the lunar base. Some of the controls which will be used are monitors, lights, switches, and keyboards.

With regard to the monitors, the following requirements should be analyzed when selecting the type of monitor to be used: glare reduction, surround luminance, viewing distance, font, character size, and mathematical tables (NASA STD 3000, 1987).

Assuming the light located on the panel are LEDs, or light emitting diodes, the following requirements are to be met:

- intensity control LEDs capable of being dimmed
- color coding - use of LED color coding should conform to the NASA STD 3000
- lamptesting - LED indicator lights with less than 100,000 hours mean time between failure (MTBF) should require lamp testing capability (NASA STD 3000, 1987)

The advantages and disadvantages of different types of switches are listed in Tables 2.4.1.2.4-1, 2.4.1.2.4-2, and 2.4.1.2.4-3. Using this general criteria for switches, the kind and type may be selected and placed according to NASA STD 3000.

The keyboard and/or keypads have requirements for the function key types, reduction of errors, and non-ASCII key locations. Figure 2.4.1.2.4-1 shows the standard keyboard layout which is to be followed in designing a specialty keyboard.

2.4.2 FURNISHINGS AND EQUIPMENT

NASA currently provides pertinent information on space-related interiors and equipment to accommodate a range of body configuration. This range includes from the 5% Japanese female to the 95% American male. Approximate heights considered are 1.6 m to 1.9 m. This range addresses the international partnership that is anticipated between the United States, Russia, Japan, the European Space Agency and Canada.

ADVANTAGES	DISADVANTAGES
<p>Handwheels Good for high forces Suitable for 2 handed use</p>	<p>Requires substantial space Not good for fine adjustments May require two-handed operation High force operation will require good restraint system Temptation to use as hand hold or grasp under microgravity conditions</p>
<p>Levers Good for high forces Status is obvious</p>	<p>Large space requirements Susceptible to accidental displacement Temptation to use as hand hold or grasp under microgravity conditions four or more position should be avoided</p>
<p>Toggle switches Used for 2 or 3 discrete positions Efficient use of space Setting is obvious</p>	<p>Susceptible to inadvertent activation Often requires guards or shield, especially in microgravity State of activation is not always obvious Susceptible to accidental activation</p>
<p>Push button Efficient use of space Fast activation</p>	<p>Lighted push buttons cause continuous power drain May require secondary status indication Bulb failure can lead to erroneous interpretation of status Cannot use with foot restraints Susceptible to accidental activation Not recommended for critical operations, frequent use or fine adjustments</p>
<p>Foot operated switches Can be used when hands are occupied</p>	<p>Can induce forces to move operator out of position if used in micro gravity without restraints</p>

Table 2.4.1.2.4-1. Control Devices Advantages, Disadvan. (from NASA-STD-3000).

2.4.2.1 Rack Components

A rack will be a standard measured unit that will contain functional equipment, monitors, stowage, workstations, laboratory work areas, computers, and all general and specific products necessary for the operation of the lunar base. The rack should consider the following:

- a kit of parts
- compactability
- lightweight for transportability
- designed for 1/6 gravity
- address human factors and anthropometrics
- should dual function
- address survival levels as well as more "luxurious" levels

2.4.2.2 Requirements for all Functional Areas

For all the functional areas of the lunar base, racks should be designed for the following needs:

- research laboratories
- crew quarters: single, double arrangements
- hygiene facilities, both full and limited

2.4.3 MATERIALS, COLORS AND FINISHES

The general criteria for materials, colors and finishes is not very different from those in Earth-based environments. The most pressing concern will be for the specific material and its outgassing qualities. The materials used within a lunar base should address not only a functional requirement, but should suggest attention to the human element. From a functional perspective, materials should be sensitive to the following:

- outgassing minimal, preferably accomplished prior to occupation of the habitat by human crewmembers
- provide minimal maintenance for cleanability
- materials should be durable
- materials must be nonflammable

- materials must not impart chemical, mechanical or any other hazard to the crew
- materials must be resistant to abrasion, scratching, or corrosive contaminants

From the perspective of psychological benefit, materials can add aesthetic qualities to a space, can assist in task performance under illumination, and can abate acoustic reverberations within the habitat.

Color selection must be accomplished carefully within an isolated and confined environment. It should be accomplished simultaneously with the design of the illumination system. Colors should:

- enhance the human element within the habitat
- provide a variety of visual stimuli
- be selected to augment the spatial confines of the habitat
- be selected to promote ease of task performance
- allow the crewmember his/her own personalization of specific territories

Finishes of surfaces addresses most specifically the reflectances that may occur. With light absorption and scatter being minimal, there will be greater contrasts. Finishes generally should be selected so as not to produce glare or unwanted reflections. Matte or satin finishes will assist in illumination. There may be unusual spaces within the habitat that might warrant the use of a highly reflective surface, e.g., to perceptually expand a space. Those intentional uses should be kept to a minimum. Utilizing panels that can be reversed or changed-out, a crewmember will have design flexibility to suit his/her taste as well as assist in the easy maintenance of the environment.

2.4.4 ILLUMINATION

Lighting will play a key role in the success of the lunar mission objectives from both a psychological viewpoint as well as the productivity viewpoint. Illumination will address from general to specific task requirements. People have a biological need for visual information. When sensory data is ambiguous, astronauts can become uneasy or distracted and may be not able to work efficiently (Lam, 1977). The crew will need to be aware of the following:

- location, with regard to destination and escape routes

ADVANTAGES	DISADVANTAGES
<p>Pedals Use when both hands are occupied High force capability May be used where pedal has created a stereotyped expectancy</p>	<p>Cannot use with foot restraints can induce forces to move operator out of position if not restrained</p>
<p>Rocker switches Efficient use of space Will not snag clothing Status is obvious</p>	<p>Susceptible to accidental activation Can be difficult to read three-position rocker switches</p>
<p>Push-pull controls Used for 2 position control Efficient use of panel space May be used in a multi-mode fashion (e.g., on-off and volume control) to save space</p>	<p>Difficult to determine positions when used for multiple position control Susceptible to inadvertent activation</p>
<p>Slide switches Can be discrete or continuous Good for large number of discrete or positions Provide easy recognition of relative switch setting</p>	<p>Continuous slide switches susceptible to mispositioning Can be difficult to position continuous sled switch precisely</p>
<p>Legend switches Good in low illumination (if self illuminated) Fast activation Effective way to label switches Efficient use of panel space</p>	<p>Not recommended for more than two positions State of activation is not always obvious</p>
<p>Printed circuit (DIP) switches Very space efficient</p>	<p>Slow Usually require stylus to set Small size makes switch difficult to read May require stabilized hand to set and to avoid excess force</p>
<p>Key operated switches Prevent unauthorized operation Permits flush panel for seldom operated switches</p>	<p>Slow to operate Must deep track of separate key Key slot susceptible to contamination if not shielded— especially in microgravity</p>

Table 2.4.1.2.4-2. Control Devices Advantages, Disadvan. (from NASA-STD-3000).

ADVANTAGES	DISADVANTAGES
<p>Knob, discrete position rotary Used when 4 or more detented positions are required Resistant to accidental actuation</p>	<p>Not recommended for 2 position functions Relatively slow</p>
<p>Knob, continuous position rotary Good for precise settings Single- or multi-turn capability</p>	<p>Potential parallax error Relatively slow Susceptible to misinterpretation if multiple turn Sensitive to accidental activation Difficult (time consuming) to re-establish setting if switch is moved inadvertently Three-knob assembly not recommended</p>
<p>Knobs, ganged Efficient use of space</p>	<p>Relatively slow Not recommended for gloved use Susceptible to erroneous settings Not recommended when frequent changes are required One knob may move if inter-knob friction exists (may require two handed operation).</p>
<p>Thumbwheels Compact</p>	<p>Not recommended for fine control Slow, not recommended for high traffic functions Can cause intermediate and inadvertent inputs Susceptible to inadvertent activation Position or selection may be difficult to assess in dim light</p>
<p>Cranks Used when multiple rotation are required Fast Can handle high forces Can be used for coarse and fine adjustments</p>	<p>Requires space Susceptible to accidental movement Tempting hand hold or grasp under microgravity conditions</p>

Table 2.4.1.1.2-1. Control Devices Advantages, Disadvan. (from NASA-STD-3000).

- time, to orient biological clocks
- physical security and enclosure, regarding the safety of the structure
- territory, crew member boundaries and opportunities for personalization
- places of refuge, shelter in time of perceived danger

These needs for visual information can be addressed with lighting by creating the subjective impressions of visual clarity, visual relaxation, privacy, spaciousness, crew control and personalization, time and space orientation, and safety.

Visual clarity refers not to how well lit an area is, but to its lack of haziness or visual gloom. The lighting in a space may be sufficient to see the task at hand, but may still be flat and shadowless. The failure to meet user expectation for visual information is a more likely cause for gloominess than inadequate light (Lam, 1977). Visual clarity is especially important in the laboratory where the crewmembers will be working for extended periods and the need to recognize color codes accurately will be important. Visual clarity is reinforced by:

- higher luminance on work and ceiling plane
- higher luminance in central part of the room
- cooler-toned continuous spectrum light sources (Steffy, 1990)

A sense of relaxation is needed in casual spaces such as the crew quarters, passive recreation and the wardroom. Visual relaxation is reinforced by:

- non-uniform lighting to provide darker areas to look to
- interior windows
- warm-toned surfaces (Steffy, 1990)

The laboratory areas can also benefit from these design criteria. By combining relaxation with visual clarity, a comfortable yet highly productive environment can be created (Steffy, 1990). The impression of privacy is appropriate for more intimate casual spaces such as the crew quarters and passive recreation. Privacy can be reinforced by:

- non-uniform lighting
- wall lighting
- low luminance in the zone of the user

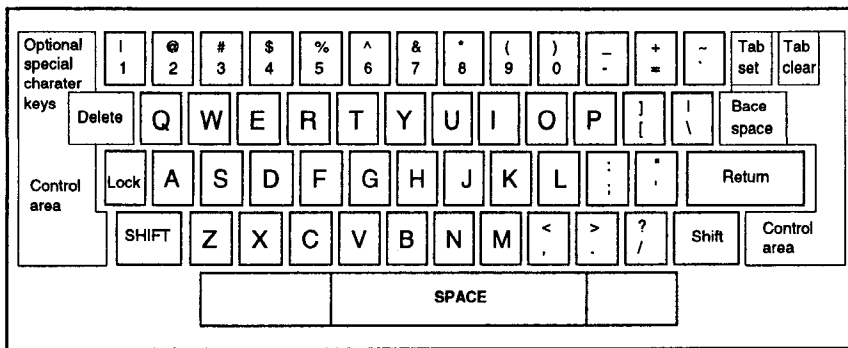

Figure 2.4.1.2.4.-1 Standard Keyboard Configuration (from NASA-STD-3000).

- higher luminance surrounding the user (Steffy, 1990)

A feeling of spaciousness is important in areas of circulation and in cramped spaces. Spaciousness is reinforced by uniform lighting and uniform wall lighting to make the wall surfaces appear lighter in value in comparison to the ceiling and the floor.

For crew control and personalization, each area should have moveable or adjustable fixtures to accommodate furniture rearrangement and dual functions. Excluding circulation, each area should allow crew control of light brightness with dimming switches or ceiling fixture independence.

Time and space orientation should be reinforced by lighting because of the habitat's lack of inherent environmental information and Earth-like sensory stimulation. Lighting can help in defining spatial and surface changes. Changes in brightness and hue throughout a 24-hour day in the habitat might be used as stimulation for daily rhythms.

For safety, lighting should be used to articulate circulation paths. An emergency lighting system should be available in the event of a temporary power supply failure. The status of the structure should be indicated with lights spaced throughout the habitat. This gives objective information and reinforces the subjective impression of safety.

2.4.4.1 General Illumination Requirements

The habitat lighting system should optimize viewing conditions for all crew activities. Ambient light should be placed to enhance the interior volume of the habitat and emphasize its spatial functions. Brightness, direction, color, and concentration of task lighting should be determined

by the task and the amount of time spent on the task. Task lighting should reinforce the visual information required for the area by not obscuring the task with shadows, glare, or veiling reflections.

2.4.4.2 Human Factors Requirements

The following issue should be addressed when considering an illumination scheme for a lunar environment:

- privacy: non-uniform lighting and low illumination in the zone of the user/high illumination surrounding the user
- visual relaxation: non-uniform lighting (darker areas to look to), interior windows, and warm-toned surfaces
- spaciousness: uniform lighting, uniform wall lighting
- crew control/personalization: fixture moveability, adjustability, variable brightness, ceiling fixture independence
- time orientation: simulated sunrise and sunset
- safety: exit lighting and status or emergency lights

2.5 BUILDING SYSTEM REQUIREMENTS

To provide a conceptual proposal for a lunar base, it is necessary to review what has been considered by the aerospace community to date. Included in this investigation are methods of construction and the use of particular materials that may prove appropriate for the lunar environment. In addition, given the vacuum and the intensity of what impacts the surface, attention needs to be paid to methods of protection from a number of environmental elements.

2.5.1 MATERIALS

All materials chosen should be expected to last a given lifetime. Replacement of components will be costly and, depending on the type of failure, possibly endanger human life. The ability to function as intended for a specific service-life depends upon the resistive qualities against surface fatigue, abrasive wear, chemical reaction, contamination, depletion (off-gassing) and punctures. The severe climate of the Moon's temperature gradient (-171 degrees C to 134 degrees C) changes quickly and remains for

extended periods of time. Materials in contact will need to have similar coefficients of expansion over this wide temperature range. Radiation from the sun and galactic cosmic radiation (an isotopic flux of protons, alpha particles, and heavier nuclei) pose a constant threat to materials. Radiation, in the form of solar flares, ultraviolet radiation and galactic cosmic radiation (GCRs) will be to lunar equipment as oxidation is to Earth-based elements. Solar particle events (SPEs) are a wind of high-energy protons with fluxes up to 100 cm per sq. s resulting from explosions in the sun's chromosphere. "Because of the Moon's very small magnetic field and nearly absent atmosphere, space radiation bombards lunar base structures directly with negative consequences for both biological and material systems" (Sherwood & Toups, 1992). Radiation is very detrimental to organic compounds and polymers; deterioration happens very quickly. The Moon has no atmosphere, resides in a hard vacuum which also poses design problems. "Most organic materials and some inorganic material evaporate or outgas volatile substances. In a vacuum, certain materials begin to offgas which on Earth do not. The importance of preventing contamination of life support systems and equipment from outgassing will restrict the materials available for use. Many metallic surfaces rapidly form a protective oxide layer which prevents seizing and galling. In space, such protective films do not form, possibly leading to microwelding of asperities and rapid adhesive wear of components. Graphite, a powdered lubricant commonly used on Earth, becomes abrasive in the vacuum of space due to the loss of water at the edge of molecular slip planes" (Ramsey, 1991). Materials must be lightweight, high in strength and easily cared for.

2.5.2 CONSTRUCTION SYSTEM

Construction using foreseeable technology will be dependent on lunar-based and Earth-based telerobotics and EVA. Smart robots would save time and money; however, presently their development is questionable. It can be taken for granted that all first generation machinery will have been brought from Earth. Restricted by transportation limitations, these machines will need to perform multiple tasks. Control will come from three different sources as mentioned above. Large objects, such as the habitat, will have self-deploying phases, assisted by construction machinery. Sequencing of construction and comprehensive design will be the key to a successful deployment of a lunar outpost.

2.5.3 STRUCTURAL SYSTEM

The habitat needs a structural system which satisfies the following needs:

- internal pressure of 101.4 kPa
- sustain load from regolith cover or ability to withstand radiation exposure
- survive impact of micrometeoroids
- be able to support internal rack systems
- ability to handle live loads
- support entrance and exit points
- withstand radiation exposure
- be flexible
- be easily erected and retrofitted

The first lunar outpost may be brought intact from Earth, ready for use with little preparation. The habitat which will be used for long-term stays needs to house additional crewmembers for longer periods. This demands innovative structures that will meet requirements costs effectively.

2.5.4 CONNECTIONS

Connections must provide locking, airtight seals between two objects. It is critical that the connection must allow the easy translation of a fully-suited astronaut. Equipment, supplies, and racks must pass through as easily, without the extensive assistance of a second crewmember. The following considerations must be addressed:

- internal door placement — enclosed crew stations shall have entrances or exits to permit unrestricted flow for all anticipated traffic, and shall be located so personnel ingressing or egressing will not interfere with surrounding operations or traffic flow
- emergency passate — capability shall be provided to allow emergency egress and rescue entry into a compartment
- external pressure hatches — hatches opening directly to the vacuum of space shall be self-sealing and inward opening
- windows — airlock hatches shall incorporate windows for visual observation of all airlock operations with a minimum of blind spots inside the airlock

- EVA operation — all opening/closing mechanisms shall be operable by a pressure-suited crewmember
- operation shall be accomplished from both sides of the connection
- connections may be operated by a single crewmember
- connections shall be self-aligning
- connections should have provisions against dust contamination

2.5.5 HAZARD SHIELDING

As extended duration lunar missions are envisioned, environmental parameters such as high-energy, charged particle radiation from solar flares and GCRs become critical. Large solar flares can release great quantities of high-energy nuclei for time periods as long as several days. As well, very high-energy GCRs bombard the Moon steadily from sources outside the solar system. Unlike Earth, lunar inhabitants will not have the protective cover of an atmosphere against this radiation; therefore, health and safety may be endangered. Allowable dose limits for crewmembers have been set and therefore shielding must provide adequate protection. The lack of a significant atmosphere on the Moon will allow the tiniest particles to strike the surface with their full velocities, as high as 20 km/sec. (Sherwood & Toups, 1992). No damage can be caused by micrometeoroids striking the habitat. The depth of protective cover depends upon the material used. In the case of radiation, the exposure will most likely vary throughout the habitat. The design should take advantage of equipment that provides protection by placing sleeping quarters or other high occupancy rate activities behind them.

2.5.6 ENERGY CONSIDERATIONS

The energy needs of the lunar base have to be met by utilizing some sort of power generation system. To obtain this energy, there are several requirements that must be addressed:

- determination of electrical energy needs
- determine the source of the energy
- methods of power transfer needed
- resistive losses determined
- location of supply sources

Though these requirements may be necessary, more research need to be done to determine if certain criteria for establishing power is feasible.

2.5.7 CONSTRUCTION SEQUENCING

A smooth construction progression is necessary and must be fully delineated prior to launch. Presently, there is no roadway system on the lunar surface to use in the transport of materials, nor are there transportation materials themselves. Both of these issues need to be resolved. The sequencing should incorporate resources, time, energy and equipment. precursor missions will have accurate mapping of the site location. Dependent upon the method of construction, equipment may have to be transported to the surface prior to arrival of FLO. Any surface preparation might be accomplished by telerobotics, if technology is available at the time. It would be prudent to deliver necessary components to the surface; components that could self-deploy would be beneficial. When the crew arrives, a cost benefit in EVA time on the surface would be realized when as much construction as is permissible by robotics could be accomplished.

With the use of a FLO site, the crew could commence construction of the habitat portion of the permanent site. Again, minimal EVA time is desirable, especially if any construction can be accomplished from the FLO lander. Once the habitat is erected, it will need a hazard protection system deployed above it. This is an area that needs further investigation and design. Considerations have been made with regard to the ease of deploying the system - erecting it prior to or post-construction of the habitat. Methods of containment of the lunar regolith and the depth to which the regolith must be placed over the habitat are still under investigation. Current thought directs the design of regolith protection to minimally be at a depth of .5 - 1.5 m.

As the habitat exterior volume is completed, a power supply should be connected to the shell to aid in the interior configuring of the structure. A solar array field should be the primary system of choice. A redundant system under consideration will be a nuclear power generator. Once the exterior is constructed, airlocks must be attached to allow ingress and egress of the crew. Redundant points of egress are mandatory. Provisions for this requirement must be made early in the construction progression.

Launch and landing facilities can be constructed as well as roadways linking vital portions of the base. Required is the linear axis of the base configuration. This corresponds with the launch and landing flight

patterns, with provisions being made so that no spacecraft directly passes over the habitat or power sources.

2.5.8 EXPANDABILITY AND RETROFIT

The possibility of expansion is desirable as the lunar base matures into a self-supporting entity. Expansion may occur in three ways: within the same site, or adjacent to an existing site, or in an altogether new area. It should be considered that as the base functions expand, there may be a need for additional personnel to inhabit the facility. As well, laboratories may expand, add new abilities, and raise the level of sophistication of the science being performed. This will result in the demand for additional space. The lunar base must be designed at the outset to incorporate this possibility.

With the passage of time, there will be an expected lifespan for the equipment, materials and structure of the habitat. The design must address the need for future replacement or remodeling of the structure. Components that can easily be replaced, such as the rack systems, will be beneficial. This ease of retrofit will alleviate the necessity to abandon the base when it has lived out its life. Cost economy demands that the habitat and surrounding facility have the capability of being expanded, repaired or components replaced, again with minimal EVA time required for the crew.

3.0 DESIGN CONCEPTS: PROPOSALS FOR LUNAR BASES

The design strategy for the studio program demanded that numerous design concepts be analyzed. These addressed not only architectural concepts but included general technology concepts as well. Investigation of the following concepts was conducted.

3.1 GENERAL TECHNOLOGY DESIGN CONCEPTS

As stated by SICSA (Sasakawa International Center for Space Architecture, 1989), basic concept designs were developed as possible methods of constructing the different types of architecture to be analyzed for possible lunar base configurations. These basic concept designs are listed as follows: membrane structures, tents and screens, and laminated bladder systems. Kline, McCaffrey and Stein (19—), offer the concept of the common module.

3.1.1 MEMBRANE STRUCTURES

Stretched fabric and inflated bladder structures offer clear advantages to create large, easily-deployed protective screens or enclosures which are highly compactible for launch. Examples of uses can include shields for protection from natural and man-made debris, sun shades for thermal and lighting control, large trash management containers, airlocks and transfer tunnels, and pressurized habitats for people or plants.

Possibilities for practical, beneficial membrane applications in space are being enhanced by continuing advancements in nonmetallic material technology. Some of these materials, such as Kevlar 29, used in bullet-proof vests, are stronger than stainless steel and comparable in weight to Nylon and Dacron. Others can withstand high temperatures and have properties such as remaining flexible or becoming rigid at these extreme temperatures. Figures 3.1.1-1, 2, and 3 show uses for membrane structures. These examples are from Bell & Trotti, Inc. and the Goodyear Aerospace Corporation.

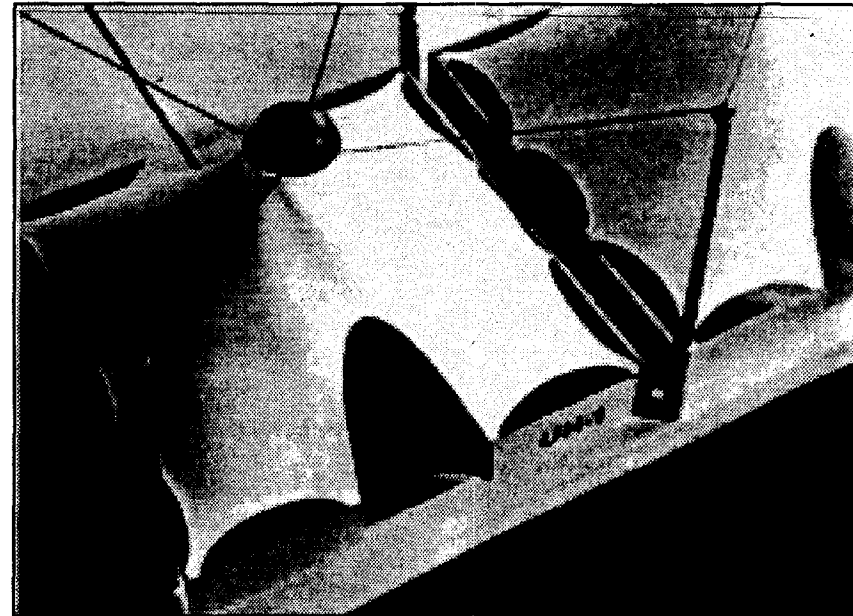

Figure 3.1.1-1 Membrane structure using materials engineering technology (from Bell & Trotti, Inc.).

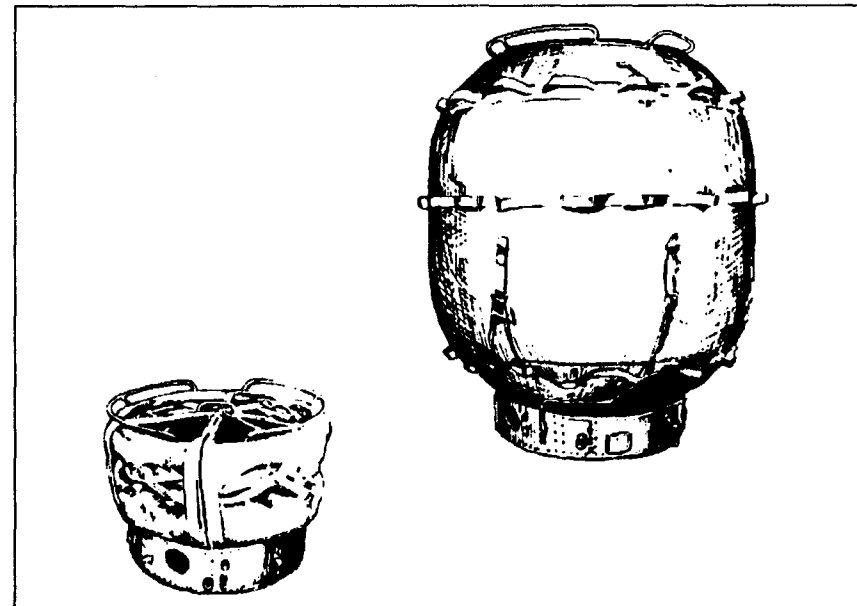

Figure 3.1.1-2 Inflatable airlock concept provides compact, yet sturdy connection that will be highly used (from Goodyear Aerospace Corp.).

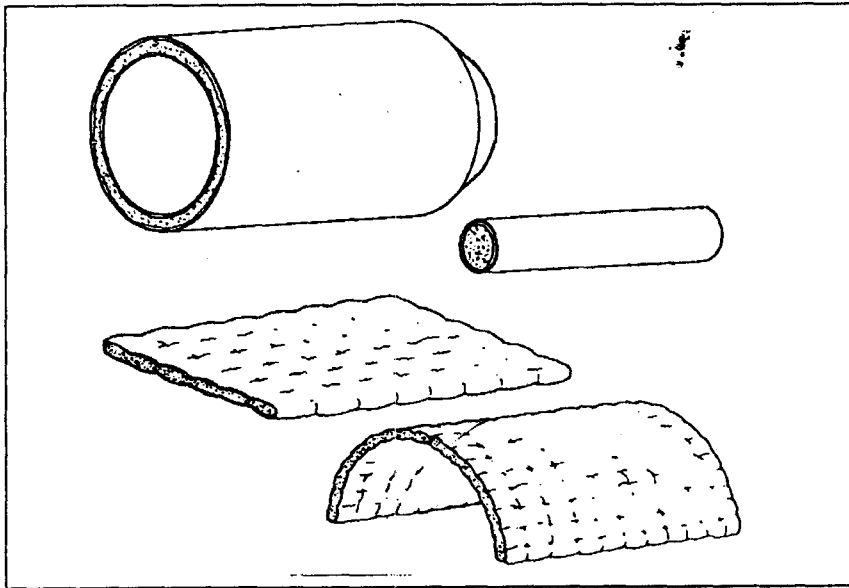

Figure 3.1.1-3 Foam-rigidized tubes and bladders provide additional structural integrity (from Goodyear Aerospace Corp.).

3.1.2 TENTS AND SCREENS

Fabric structures can help shield people and equipment in exposed space environments from extreme day-night thermal cycles, solar glare, and abrasive, sometimes hazardous debris particles. One orbital application could be a tent-like enclosure serving as an unpressurized hanger and maintenance facility for Orbital Transfer Vehicles (OTVs). SICSA, at the University of Houston, shows lunar or Mars surface applications might include screens and canopies to protect vulnerable areas from rocks ejected during launch and landing operations. They can also be used to protect supply and equipment storage areas from heat, micrometeoroids, and dust. Figure 3.1.2-1 shows an example of thermal protection using the tent concept.

3.1.3 LAMINATED BLADDER SYSTEM

Multi-layered inflatable membranes have been used by the United States to create a shuttle-spacelab transfer tunnel, and by the Russians to produce a VOSTOK 2 spacecraft airlock. In addition to creating and testing

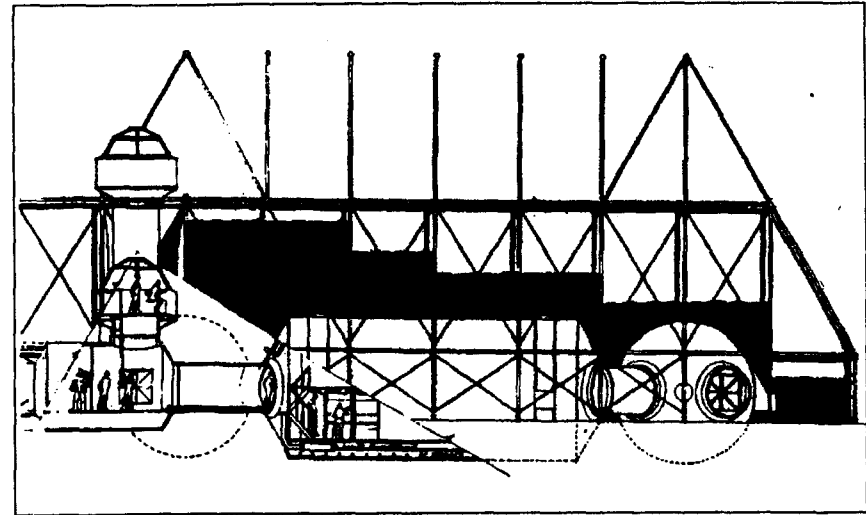

Figure 3.1.2-1 Tents and screen concepts will provide unpressurized environments for equipment and additional surface stowage (SICSA).

systems for both types of purposes, the Goodyear Aerospace Corporation (GAC) also applied composite wall technologies to produce a 7-foot diameter, 15-foot long lunar shelter and larger pressurized habitats. This laminated construction typically embodies an outer thermal protection coating, a micrometeoroid barrier, a pressure bladder, and an inner flame/gas barrier. The resulting flexible but semi-stiff structures can be folded in an "accordian" or necked-down "toothpaste" fashion. Show in Figure 3.1.3-1 is an example of a laminated bladder system.

3.1.4 RESIN FOAM-RIGIDIZED STRUCTURES

It is possible to develop structures that remain rigid after the inflation gases are gone. This may be desirable to create hangars requiring large openings to accommodate vehicles, and which are impractical to pressurize. SICSA suggests that rigidization can be accomplished by impregnating a flexible mesh core inside the bladder wall with a plastic resin foam that is activated to expand and harden under space vacuum conditions. Another method would be to pump the foam into a double bladder wall cavity following inflation. In either case, the foam can provide added protection against micrometeoroids and other debris. An example of the foam-rigidized concept is shown in Figure 3.1.4-1.

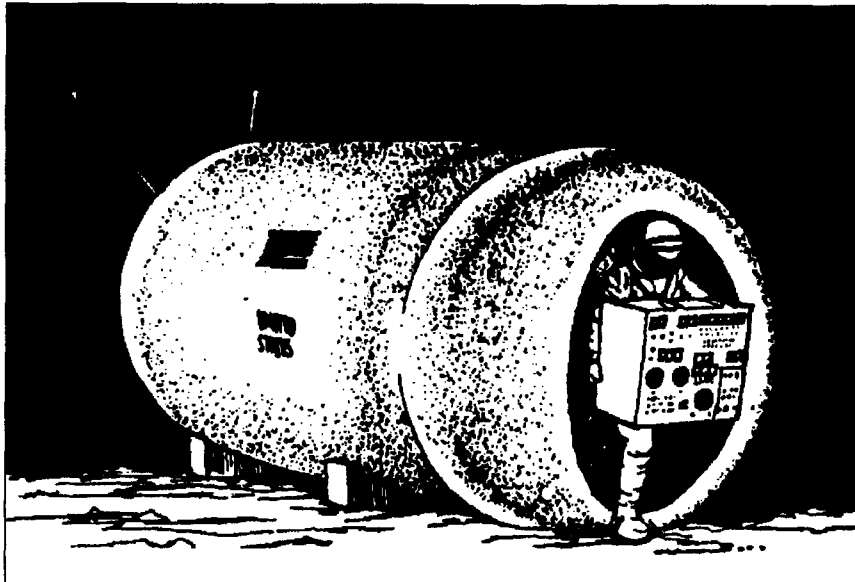

Figure 3.1.3-1 Inflatable lunar shelter concept (from Goodyear Aerospace Corp.).

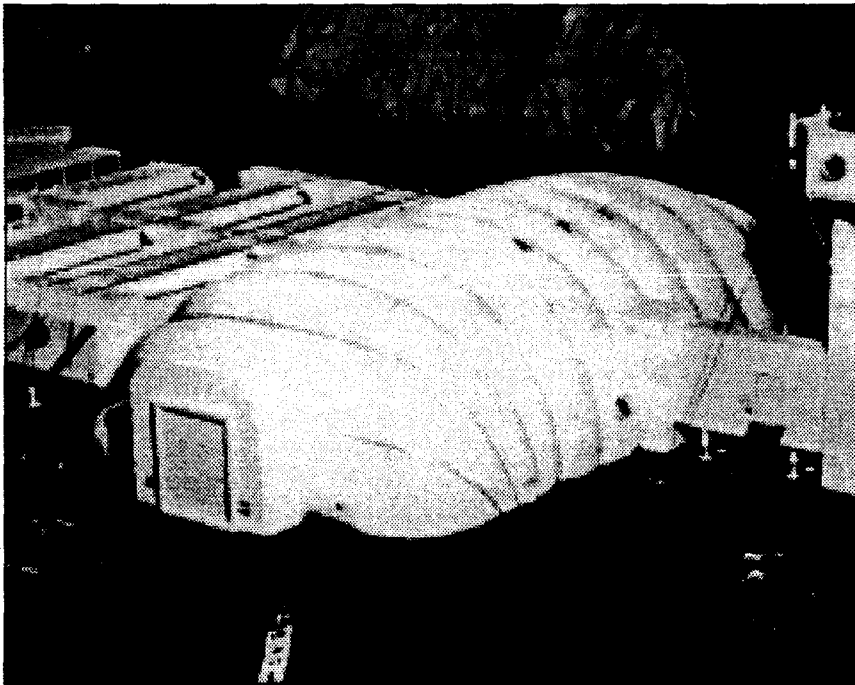

Figure 3.1.4-1 Foam-rigidized inflatable shelter concept (SICSA).

3.1.5 COMMON MODULE CONCEPT

Space station mission analyses indicate that a pressurized habitation module will initially be required to support a crew of six to eight. As crew size increases, replicated habitation modules can be used housing additional crew. Kline, McCaffrey & Stein (19—), have been studying the uses of common modules. Figures 3.1.5-1 and 3.1.5-2 are common module concept designs.

3.2 ARCHITECTURAL DESIGN CONCEPTS

From the general concept designs are some fundamental principles to architectural designs. The following designs were analyzed: suspended inflatable structure project, hard-module, rack architecture, *Genesis I* Hybrid Triangular Module Design, PAX Permanent Martian Base Concept, Underground Hard-Module Linear Architecture Concept, *Genesis II* Hybrid Underground Architecture Concept, Earth-Sheltered Family Home, and Pressurized, Self-Supporting Membrane Struction on the Moon.

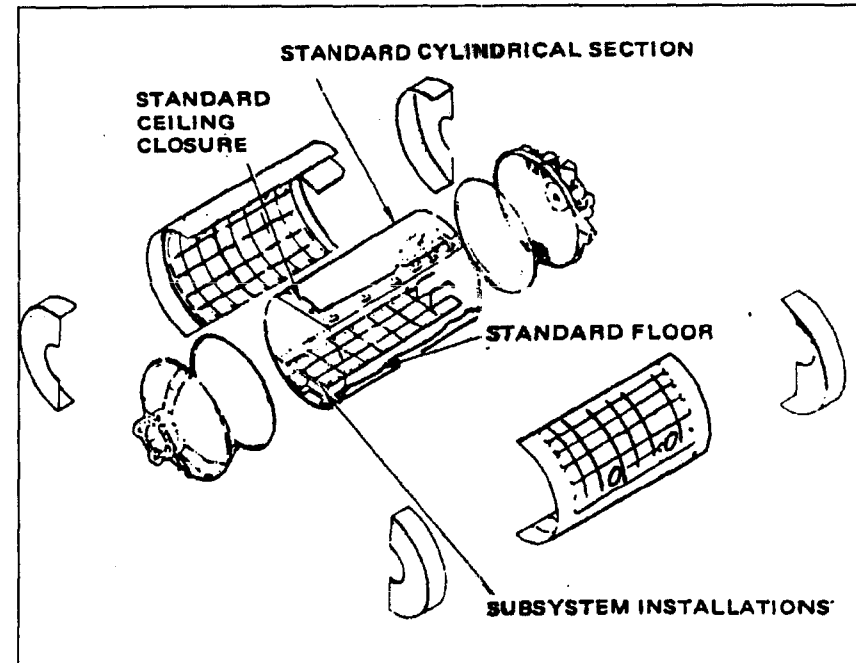

Figure 3.1.5-1 Space Station Freedom-like common module concept (Kline, McCaffrey & Stein).

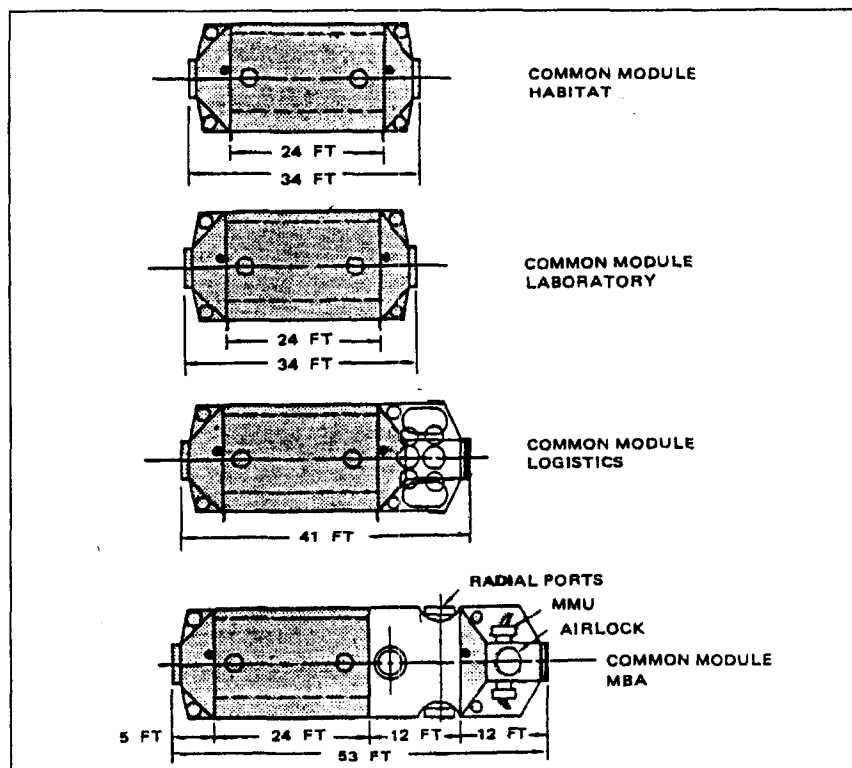

Figure 3.1.5-2 Basic SSF elements from common module (Kline, McKCaffrey & Stein).

3.2.1 INFLATABLE AND HARD MODULE CONCEPT

In 1989, the Systems Definition Branch of the Advanced Programs Office at JSC (Alred, Bufkin, Kennedy, Petro, Roberts, Stecklein, & Sturm, 1989) produced a document outlining a study evaluating lunar base systems. These included precursors, launching, transportation, site selection, and incremental growth of an outpost. Identified as well were concepts for power, thermal control, construction and assembly, and surface exploration.

This study utilized Orbital Transfer Vehicles (OTVs) to deliver payload, cargo and crew, to the surface of the Moon. Figure 3.2.1-1 illustrates the four possible mission configurations.

A progressive implementation plan commences with a construction shack. This will serve as primary housing while the balance of the habitat complex is constructed. A pressurized tunnel links the construction shack

with an inflatable habitat. Supporting dual egress will be a lunar air lock and dust-off deck. The habitat and construction shack will be covered with 1 m of regolith providing radiation protection. The protection system employs a continuously filled bag coiled around the structures (Figure 3.2.1-2).

Of particular interest is the inflatable habitat. Inflatable technology possesses the great benefit of smaller packaging, greater workable volume and a lesser mass to weight ratio, especially critical with regard to launch. Once emplaced, anchored, and inflated, the crew can construct the interior portions in a shirt-sleeve environment (Figure 3.2.1-3).

A multi-ply fabric envelope will house a nonpermeable bladder. On the exterior, a thermal coating will have been applied. The interior structure uses a spherical rib-cage, core columns, radial floor beams and a modular flooring system. The envelope will bear the pressurization loads, while the skeletal system inside will support the loads from crew, furnishings, and equipment (Figure 3.2.1-4).

The volume acquired with the inflatable technology is 2145 m³ within a 16-m-diameter sphere. Four floors of living and working space will occupy the volume interior resulting in 594 m² of floor space. The central circulation shaft will permit vertical translation between levels for crew and equipment.

3.2.2 HARD MODULE PARTIAL GRAVITY STUDY

The Partial Gravity Habitat Study was conducted in 1989 by the University of Houston College of Architecture and the Sasakawa International Center for Space Architecture. This project evaluated the habitability and design configuration of a large 6.7 m-diameter, 17.2 m-long module hard module (Figure 3.2.2-1).

The interior portion of the volume was divided into two functional levels. Paying close attention to functional layout adjacencies the design concept addresses the living and working environments and requirements for a crew of 12. The floorplans of both levels indicate the divisions of the services suggested for the crew (Figure 3.2.2-2).

The modules themselves would be configured into a geometry most appropriate for dual egress, phased growth and modularity. A key component in this concept is the entire outfitting of the module prior to launch from Earth. The module would arrive on the lunar surface, be

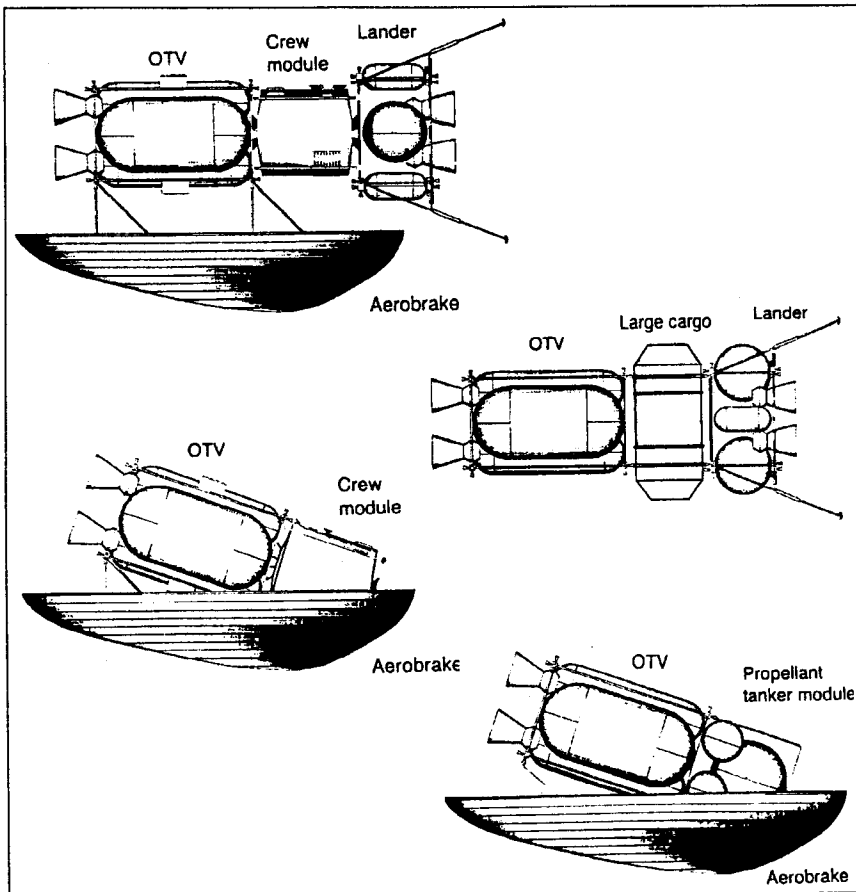

Figure 3.2.1-1 Mission configuration for a lunar outpost (Alred, et al., 1989).

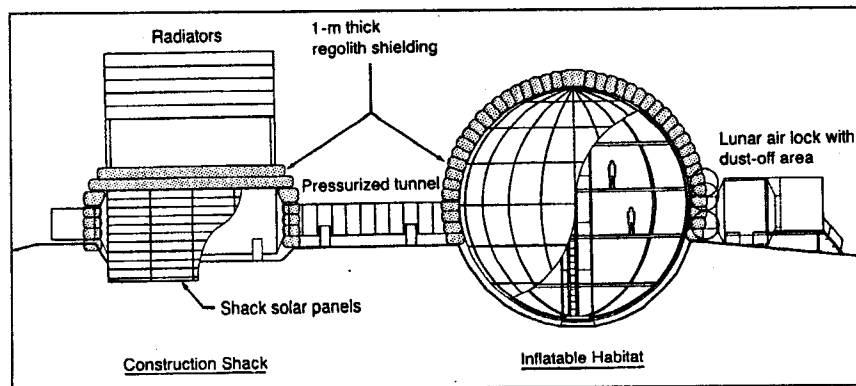

Figure 3.2.1-2 Habitat complex on the surface of the Moon (Alred, et al., 1989).

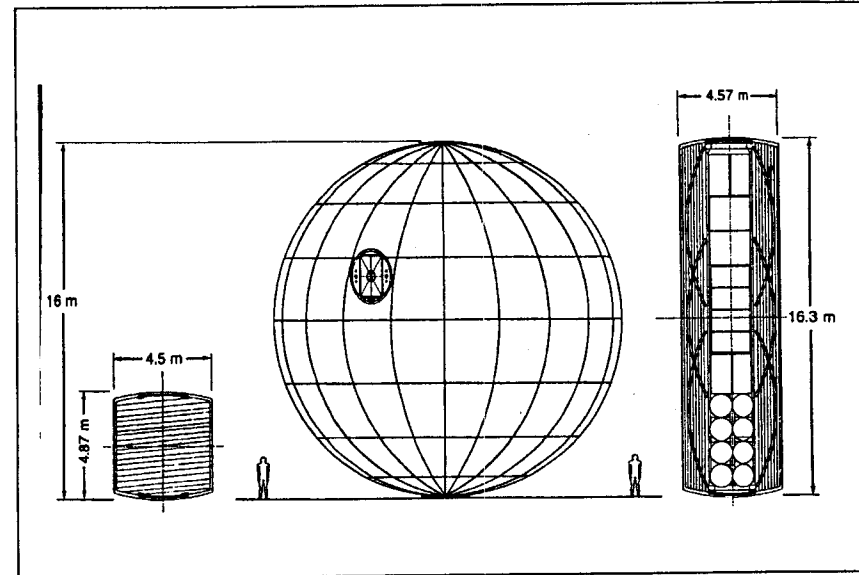

Figure 3.2.1-3 Packaging concepts for an inflatable habitat (Alred, et al., 1989).

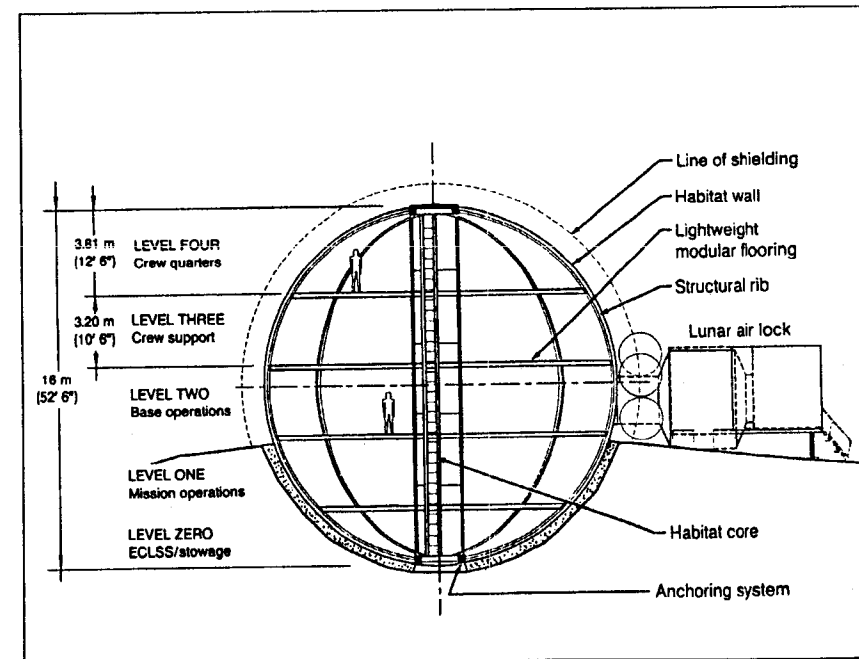

Figure 3.2.1-4 Section cut through an inflatable habitat (Alred, et al., 1989).

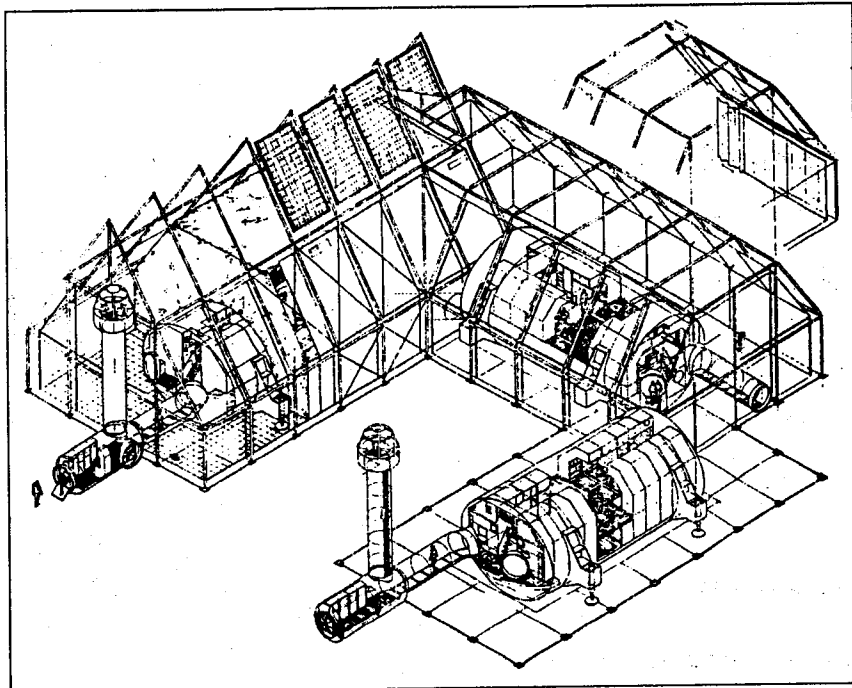

Figure 3.2.2-1 Partial gravity habitat exterior view (SICSA).

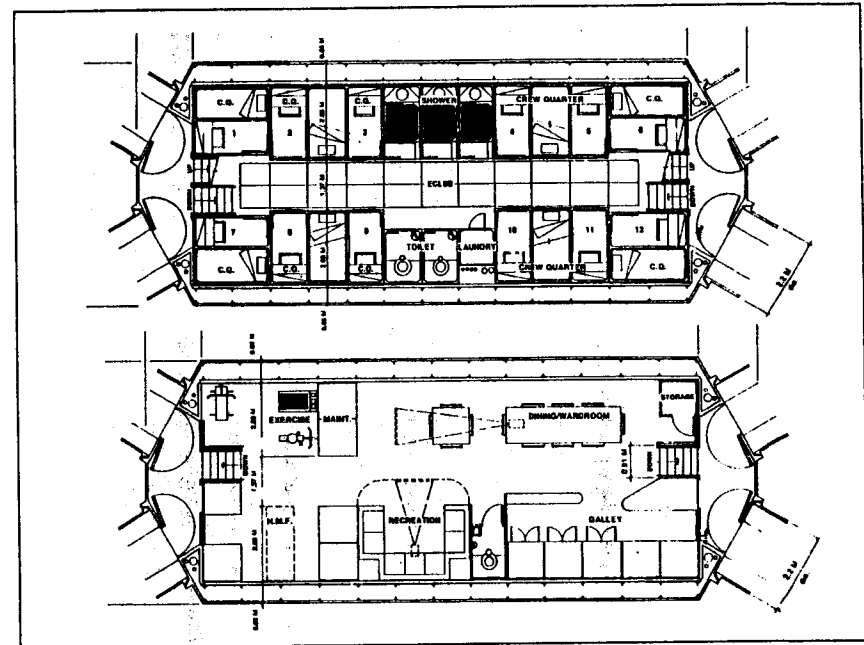

Figure 3.2.2-2 Floorplans of partial gravity habitat — upper and lower floors (SICSA).

emplaced into its prepared site, and be ready to inhabit. It would not be necessary to await payloads to be delivered containing key components. The modularity of the interior components would allow for ease of retrofit or transfer between modules.

The phased growth importance stems from the fact that these modules, when used in repeated simple geometric form, can enlarge the base tremendously (Figure 3.2.2-3).

The habitat would be protected from the radiation by a regolith containment structure. This would allow for constant temperature storage, ease of growth, and the regolith contained within a volume, as opposed to simply pouring regolith over the modules, allowing the natural slump angle of regolith to dominate. Concerns with this method of protection address the increased mass through low Earth orbit (LEO) (Figure 3.2.2-4).

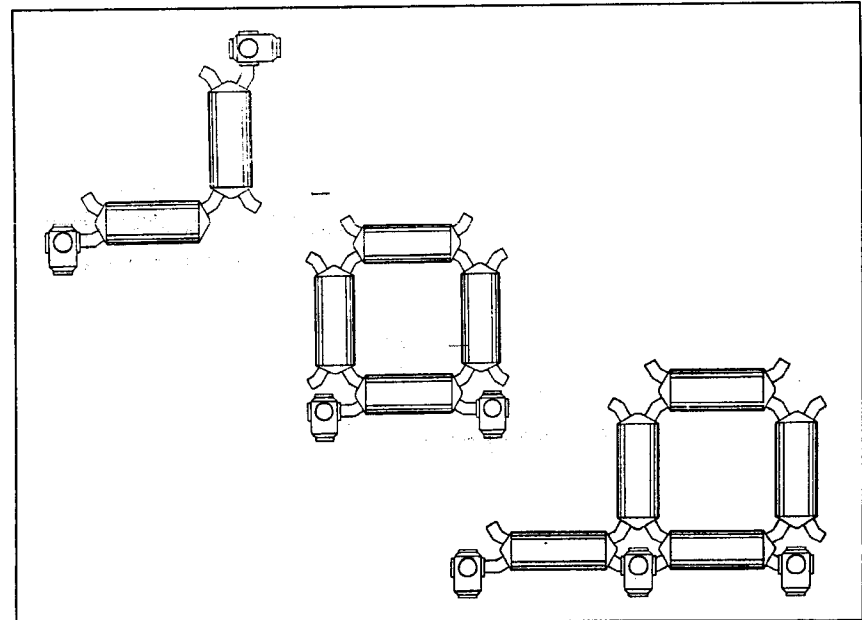

Figure 3.2.2-3 Phased growth concepts for lunar habitat (SICSA).

3.2.3 PILLOW-SHAPED TENSILE STRUCTURE

This inflatable, pillow-shaped tensile structure addresses the unfamiliar loading conditions of the lunar environment. The concept is site pressurized using suggested fiber composite materials that are preassembled on Earth. The need for radiation shielding is solved by using regolith. The depth necessary for adequate protection is not seen as a deterrent to the structural loading of the pressurized habitat. The top and bottom of the structure are loaded by the internal pressure, resulting in a curved shape. The lunar soil below must be shaped to address the "pillow" form or portions near the edges and tensile columns will lift until only a sufficient amount of contact surface remains for the internal pressure to equilibrate the gravity load (Figure 3.2.3-1).

3.2.4 HARD MODULE CONCEPT — MALEO: MODULAR ASSEMBLY IN LOW EARTH ORBIT

The MALEO concept has given crew safety and provision of a safe haven a high priority in the conceptual design. Its intent is to minimize the risk of EVA surface operations for the crew by assembling the habitat components in low Earth orbit. Once the habitation base has been transferred to the surface of the Moon, there would be a "safely configured working environment for the astronaut crew upon touchdown" (Thangavelu, 1990, pp. 271).

The components that comprise the lunar base have four configurations that would allow for future expansion. The concept uses a core of three modules: one module for habitation, one module for hygiene and one module for laboratory facilities. The modules are suspended within a truss structure and joined at the apexes by the nodes (Figure 3.2.4-1).

"MALEO LHB-1 is in essence, a large manned spacecraft and could be used as an orbiting station for the Moon and Mars. The lack of aerodynamic contours and for reasons of stability, control and propulsion requirements, the concept is particularly suited to landing on low-gravity bodies without an atmosphere, and the Moon is an ideal first choice" (Thangavelu, 1990, pp. 271.).

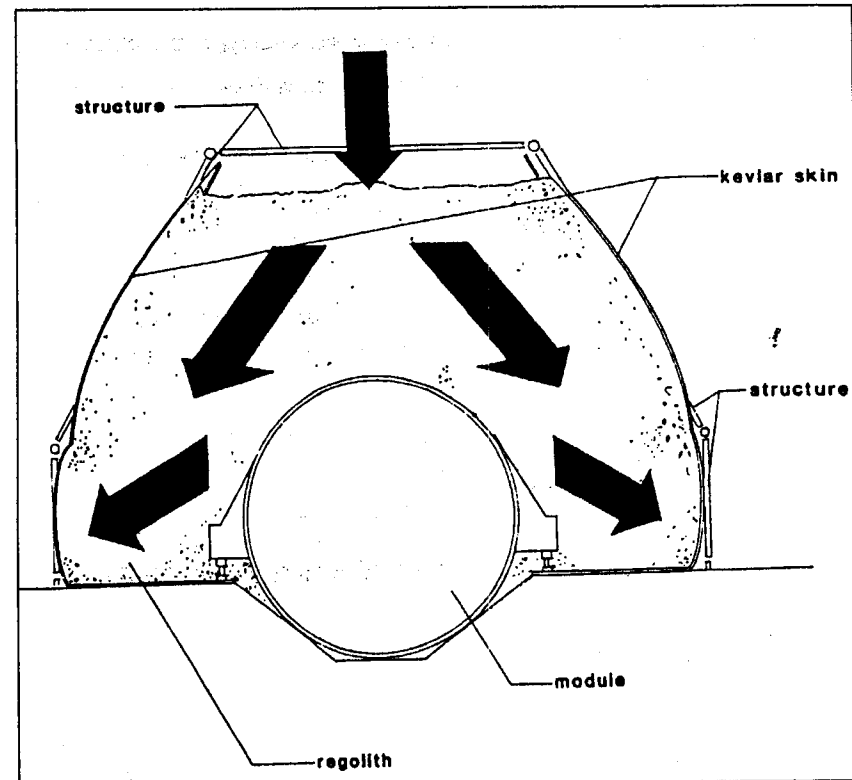

Figure 3.2.2-4 Partial gravity study loading diagram for regolith containment (SICSA).

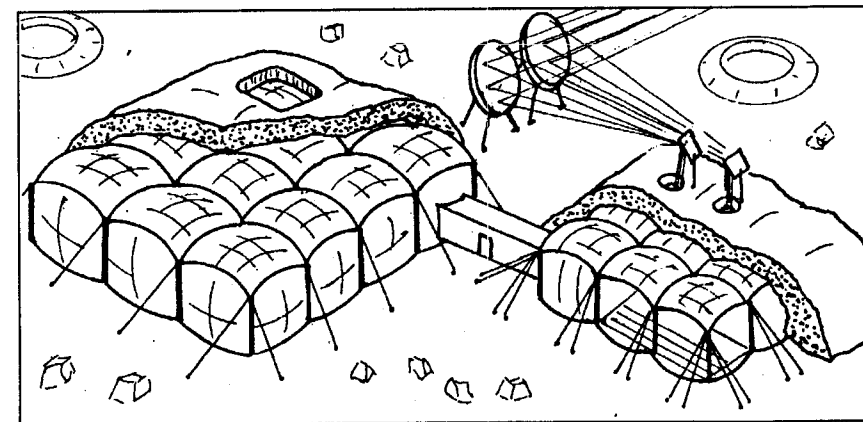

Figure 3.2.3-1 Pillow-shaped tensile structure concept (Vanderbilt, Criswell, & Sadeh, 1988).

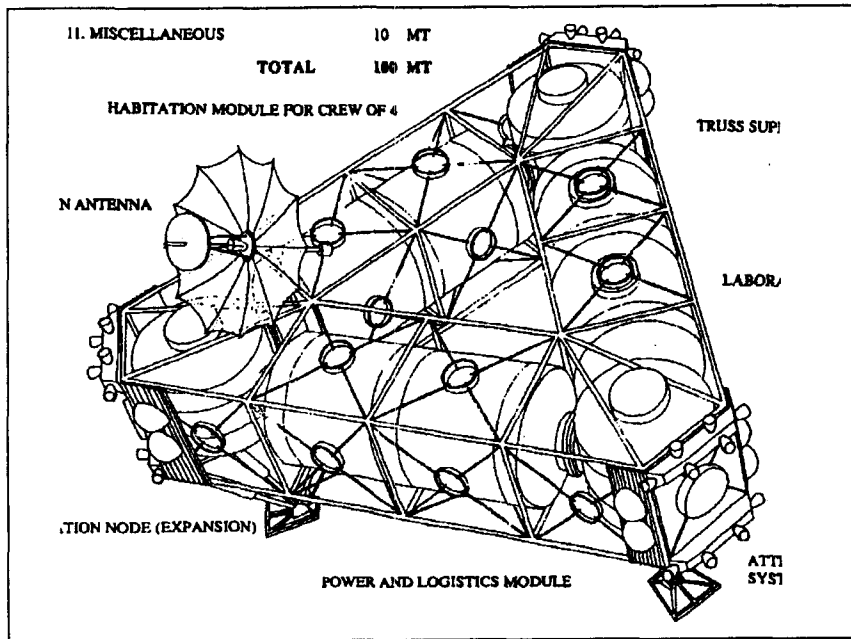

Figure 3.2.4-1 Assembly of the three-module MALEO (Thangavelu, 1990).

3.2.5 SUSPENDED INFLATABLE STRUCTURE

The basic structure is an inflatable transparent sphere. The upper part is coated with an aluminized finish to reduce solar heat build-up and provide partial shading. The floor element consists of an aluminum circular frame and a series of radial trusses. In the center, the trusses support services, storage drums, and a telescopic mast containing an umbrella which is adjusted as required to provide full shading. A translucent reinforced membrane is stretched across the frame like a trampoline, to act as a translucent floor. Other essential elements are supported by a central mast. The entire assembly is suspended by four cables from suitable ground anchor points.

The seating area converts to the sleeping enclosure at night. Access for occupants and services is provided by a lightweight bridge. Emergency egress is by means of a deployable chute. Figure 3.2.5-1 illustrates this concept.

3.2.6 EARTH-SHELTERED FAMILY HOME

The design of low profile, Earth-sheltered homes hold much potential for lunar habitats at a time when conservation issues are increasingly important. This design for an Earth-sheltered home is sunk into the landscape to avoid conflicts if located in a culturally or historically sensitive setting. Earth-sheltered homes are also highly energy-efficient, and help preserve the local ecology by minimizing the impact on the natural environment and topography.

The "doughnut" house could be built on various slopes with various depths of Earth-shielding. The basic structure is a stressed-skin circular torus with an open central courtyard viewing the sky. Access is by a short tunnel connected to the outer perimeter at a single point. The courtyard is landscaped, combining complete privacy with amply daylit internal spaces. Upward-lifting access doors provide courtyard access.

Two equipment options can be used to control and condition daylight: a revolving louvered frame around the courtyard perimeter to shade south-facing rooms, and a pivoted mirror to reflect sunlight into north-facing spaces. Primary materials options are aluminum or steel for the structural shell segments and glazing frames. The interior would use a variety of soft furnishings for walls and furniture (Figure 3.2.6-1).

3.2.7 HARD-MODULE RACK CONCEPT

As reviewed in AIAA 92-1096 (Moore & Rebholz, 1992), this concept explores the possibilities of using rigid, prefabricated Space Station Freedom-derived hard-module pressure vessels together with aluminum alloy domes and interconnect nodes. The essential geometry is a rectilinear "rack" design comprised of hard-module pressure vessels joined with connectors at the right-angle vertices and with one aluminum-titanium cylinder/dome. Figure 3.2.7-1 demonstrates this concept.

3.2.8 UNDERGROUND HARD-MODULE LINEAR CONCEPT

Explained in AIAA 92-1096, this design uses underground architecture using pressure-vessel modules in natural lunar craters and lava tubes. The essential geometry is "two-dimensional" with ingress into the habitat accessed from the lunar surface. A translation core joins the surface to the habitat portion protected underground from the environmental hazards.

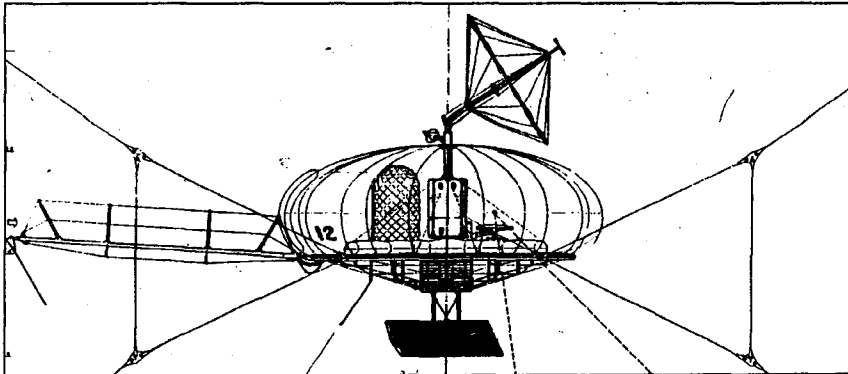

Figure 3.2.5-1 Suspended inflatable concept (Kaplicky & Nixon).

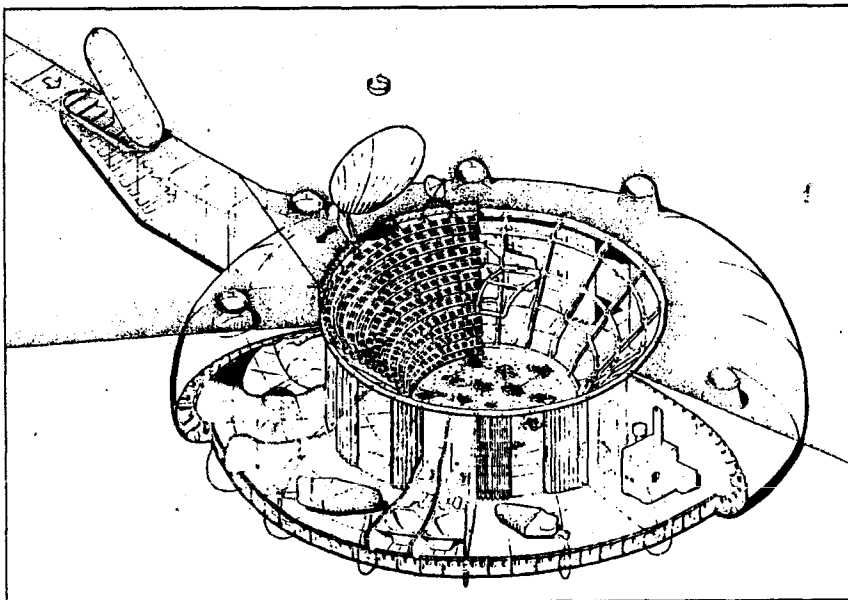

Figure 3.2.6-1 Earth-sheltered concept (Kaplicky & Nixon).

On the opposite end of the habitat, a second means of egress moves out of the living and working spaces out to the surface (Figure 3.2.8-1).

3.2.9 HYBRID TRIANGULAR INFLATABLE/HARD-MODULE DESIGN

According to the AIAA 92-1096, this design involves the use of inflatables arranged in a triangular configuration connected with hard-

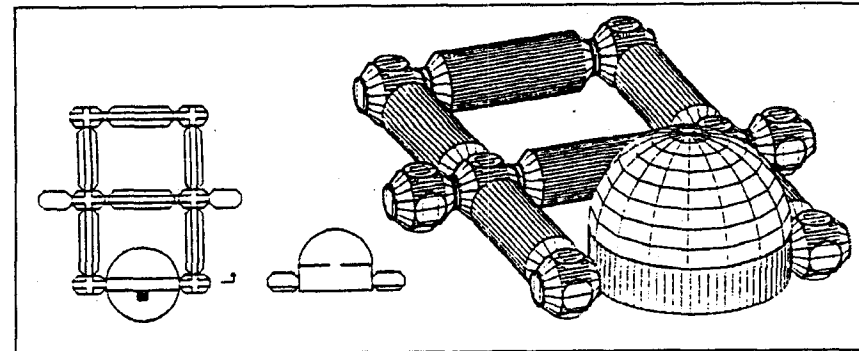

Figure 3.2.7-1 Isometric diagram of a hard-module design (from Moore & Rebolz, 1992).

module pressure vessels. The whole system is covered with regolith. This lunar outpost would consist of four major areas: a centrally located habitat/research area, a permanent nuclear power facility, a mining and production facility for the production of lunar oxygen (Lunox) and a helium derivative (H_2), and a launch and landing facility. Included in the architecture are provision for crew quarters to meet the needs of different crew members and to permit research on human habitability, workstations, specialized exercise and health maintenance facilities, and a multi-functioning inflatable biosphere. The diagram shown below in Fig. 3.2.9-1 represents this design concept.

3.2.10 HYBRID UNDERGROUND DESIGN

The *Genesis II* design concept used the hybrid underground structure illustrated in AIAA 92-1096. Following critiques offered at the national conferences by representatives of the Goddard Space Flight Center and Jet Propulsion Laboratory, this hybrid scheme uses hard modules on the surface of the Moon and at the base of a lunar lava tube, connected by a vertically configured Shuttle-C-derived module. These are joined by inflatables, and the majority of the geometry is constructed within a lava tube. The essential geometry is similar to an "I" with one-half the pressure vessels on the surface (functioning as the initial assembly facility and later resupply, logistics, and EVA). The surface components are covered with regolith. The structure below house the crew quarters, research laboratories, mission control, and crew support spaces. The 3-D view of *Genesis II* is shown below (Figure 3.2.10-1).

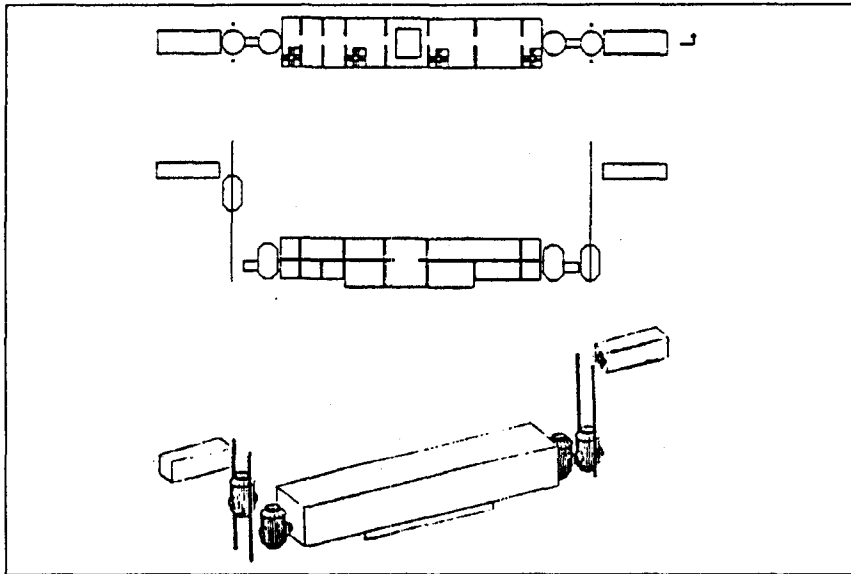

Figure 3.2.8-1 Plan, section and perspective of underground linear concept (from Moore & Rebholz, 1992).

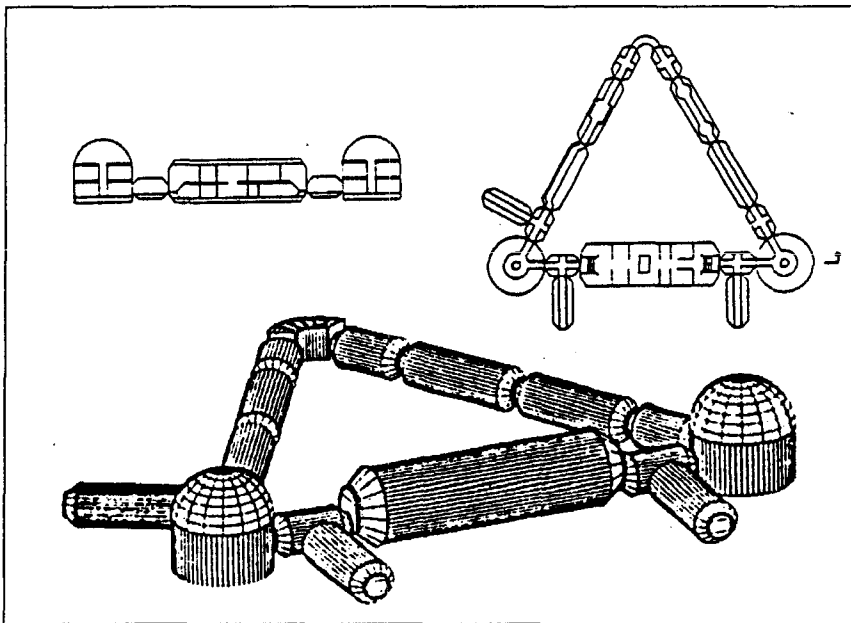

Figure 3.2.9-1 Hybrid triangular concept; plan, section, and perspective (from Moore & Rebholz, 1992).

3.2.11 MARTIAN INFLATABLE AND HARD-MODULE CONCEPT

This concept utilized a modular space frame type construction as stated in *PAX: Permanent Martian Base*. This system uses three, 9 m hard-modules, and two 12.6 m-diameter inflatables. Two of the hard modules house the greenhouses, and the third is utilized as an entry and suit stowage facility.

The two larger inflatables hold the majority of the functions - predominantly crew support and the laboratories. Three EVA airlocks and a logistics module (SSF-derived) complete the habitat. Figures 3.2.11-1 through 3.2.11-3 illustrate PAX both in plan and axonometric drawings.

3.2.12 PRESSURIZED SELF-SUPPORTING MEMBRANE STRUCTURE

As stated by Chow & Lin (1988), the pressurized self-supporting membrane structure (PSSMS) has been designed specifically to produce the optimal solution between the aforementioned two extreme cases in terms of readiness time. Being and foldable, the structure can be readily manufactured on Earth, economically transported to the Moon, and expeditiously installed within a short time. It is safe, has no foundation problems, is flexible in shape and size, and is capable of decades of service-life in the noncorrosive lunar environment.

This study is composed of a torus geometry compression ring with an exterior diameter of 18.3 m. This ring dictates the height of the structure. The concept has a net usable space value of 566.3 m³. This concept suggests that the inflated volume house apartments for crewmembers, specifically a standard four-apartment configuration. An airlock and antechamber are docked to the hatch connector. No food preparation functions are dictated for this structure; meals are to be prepared and consumed elsewhere.

Construction of the inflatable will involve an excavation of approximately 3 m. The inflatable will then be emplaced, anchored, the ring beam inflated, and the habitat backfilled around its perimeter. The next phase will be injection of the foam into the ring wall, installation of the airlock and inflation of the PSSMS. Foam is then injected into the structure, a soil bag in the bottom of the inflatable is filled with regolith, and the utility lines are deployed. The entire inflatable is then covered with 3 m of regolith, responding to the angle of repose.

After the habitat is inflated, a structural foam is injected to rigidize the inflatable. The inflatable is now a hard type of structure, self-supporting.

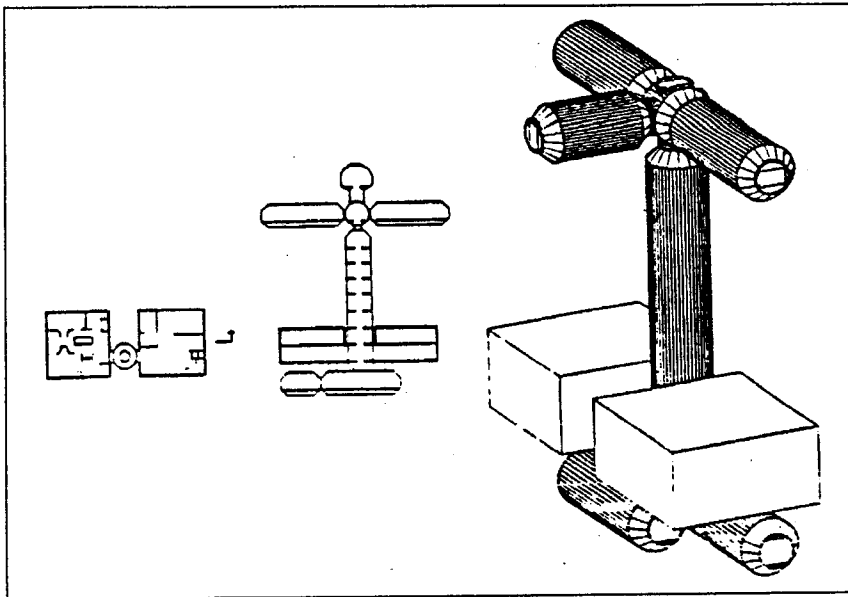

Figure 3.2.10-1 Hybrid underground design; plan, section and perspective (from Moore & Rebholz, 1992).

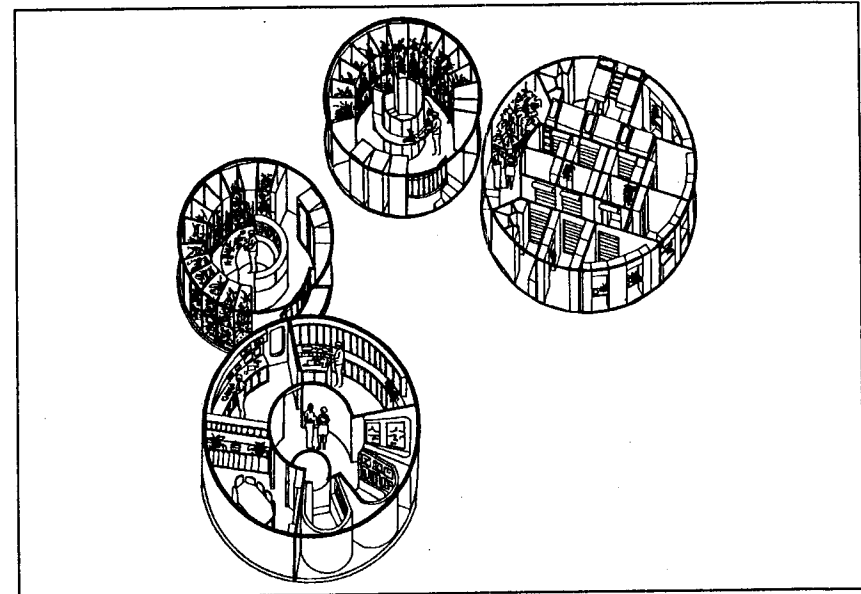

Figure 3.2.11-2 Axonometric of PAX level one (from Moore & Rebholz, 1992).

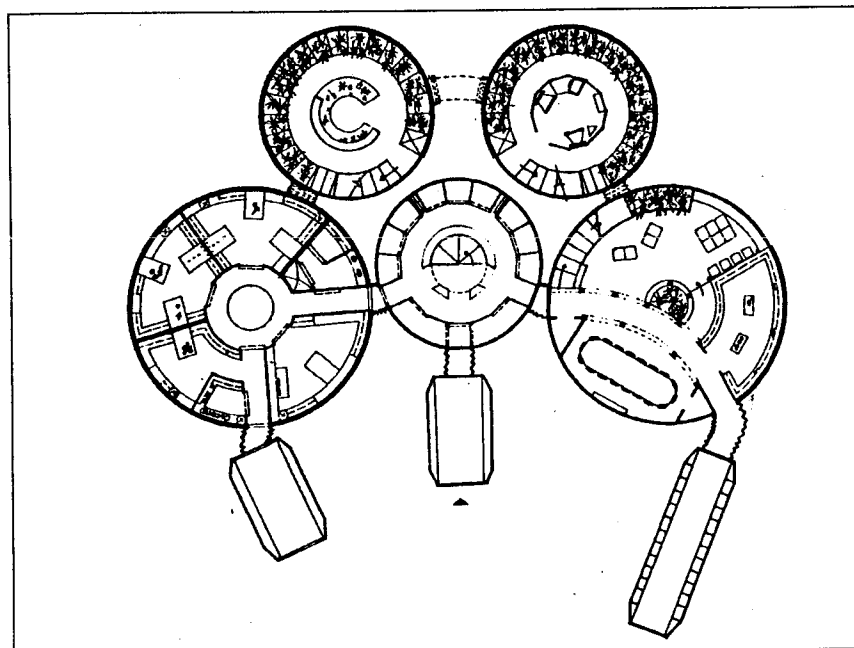

Figure 3.2.11-1 Plan of PAX habitat level one (from Moore & Rebholz, 1992).

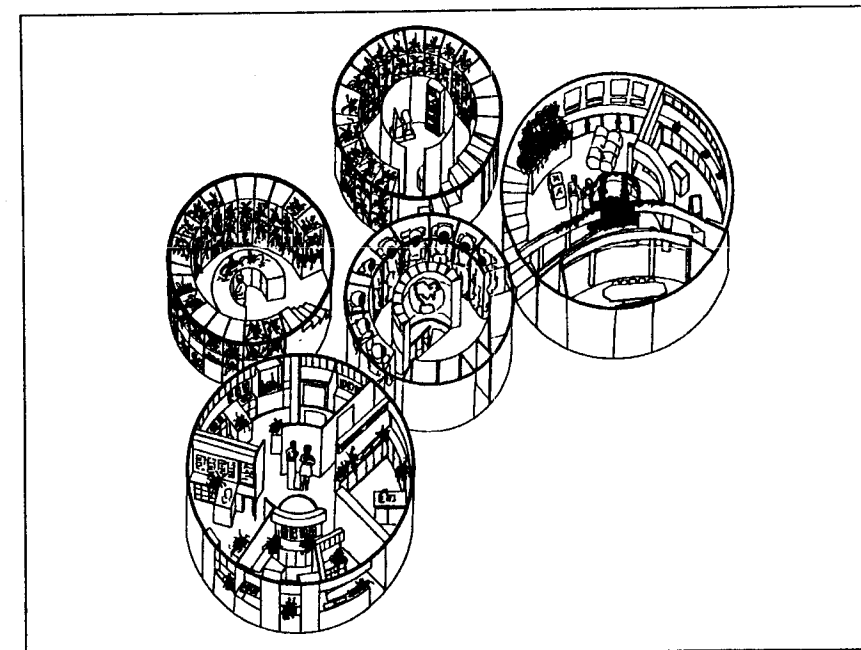

Figure 3.2.11-3 Axonometric of PAX level two (from Moore & Rebholz, 1992).

(figure 3.2.12-1)

3.2.13 RIGID DOME STRUCTURE

Buckminster Fuller pioneered construction methodology using repetitious components that could be erected with little or no human intervention. Spheroid geometries made use of minimal amounts of material as compared to the amount of volume achievable. A variety of fill-in panels can be utilized ranging from fabrics to glass to pre-fabricated and moulded panels. The greatest assets to this concept lie in the limited number of component types, simple construction, ease of replacement and near-unlimited usage possibilities (Figure 3.2.13-1).

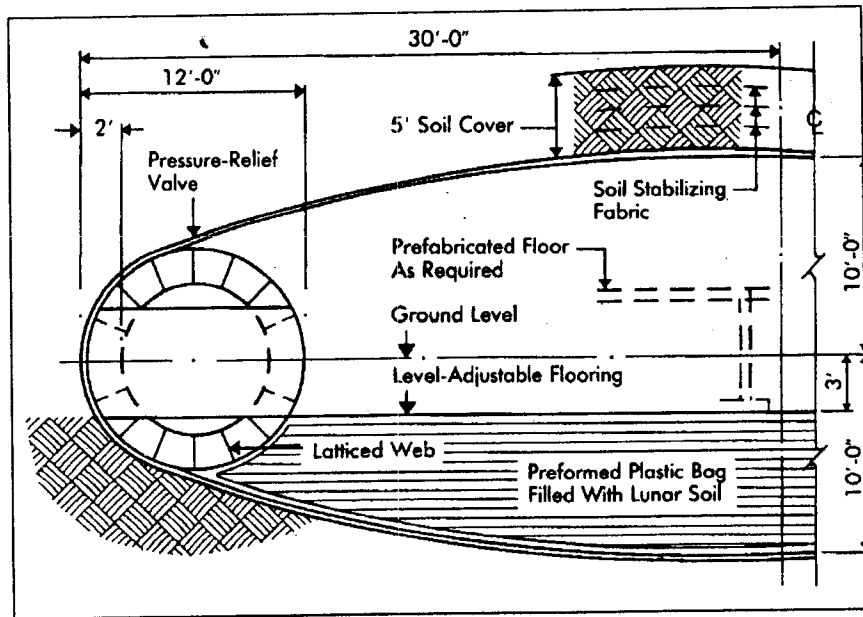

Figure 3.2.12-1 Pressurized self-supporting membrane structure cross-section (Chow & Lin, 1988).

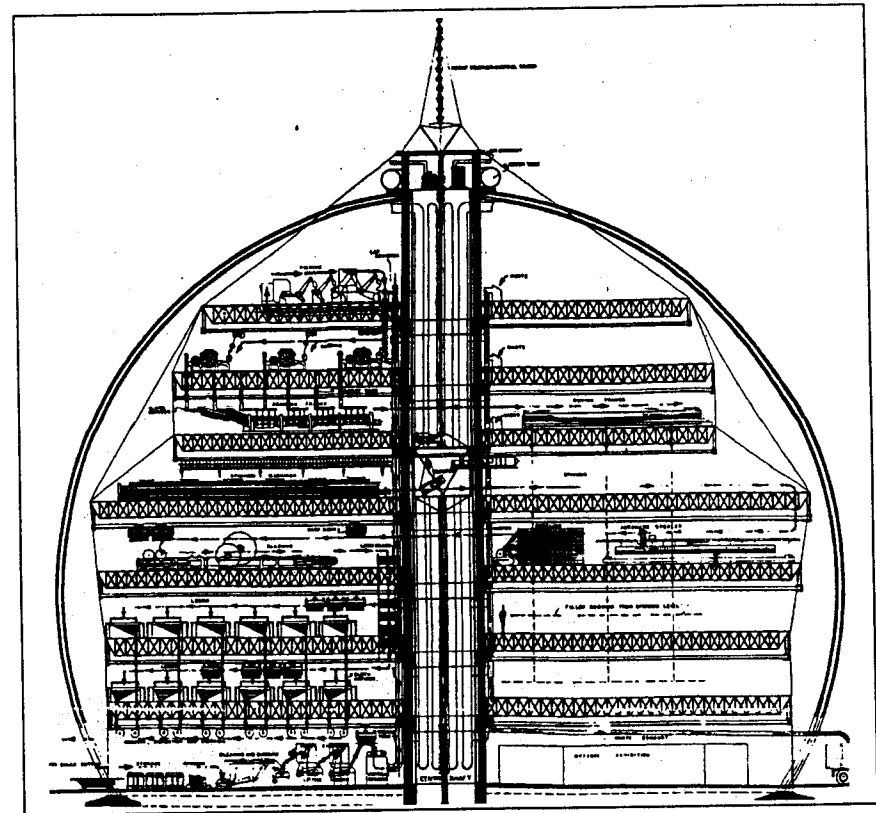

Figure 3.2.13-1 Buckminster Fuller's concept utilizing a rigid dome — section.

4.0 SITE SELECTION

Precursor missions provide extensive reconnaissance aiding in the final determination of the site, Taurus Littrow. This site has been contemplated as one of four possible lunar outpost sites. These sites have been suggested by the Solar System Exploration Division at JSC (Alred, et al., 1989). The selection of Taurus-Littrow addresses the variety necessary to support geologic science, future ISRU, investigation of the surrounding topography, and a sophistication of the already emplaced experimentation from the Apollo missions (Figure 4.0-1).

The Apollo 17 landing at Taurus-Littrow celebrated the sixth and final human mission to the Moon in December 1972. The planning for this site was probably the best of any Apollo mission due to previous experience and extensive orbital data from Apollo 15. Mission objectives included photography, sample return, radiation environment study, soil mechanics, surface-based geophysics, selenodesy measurements, and meteoroid studies.

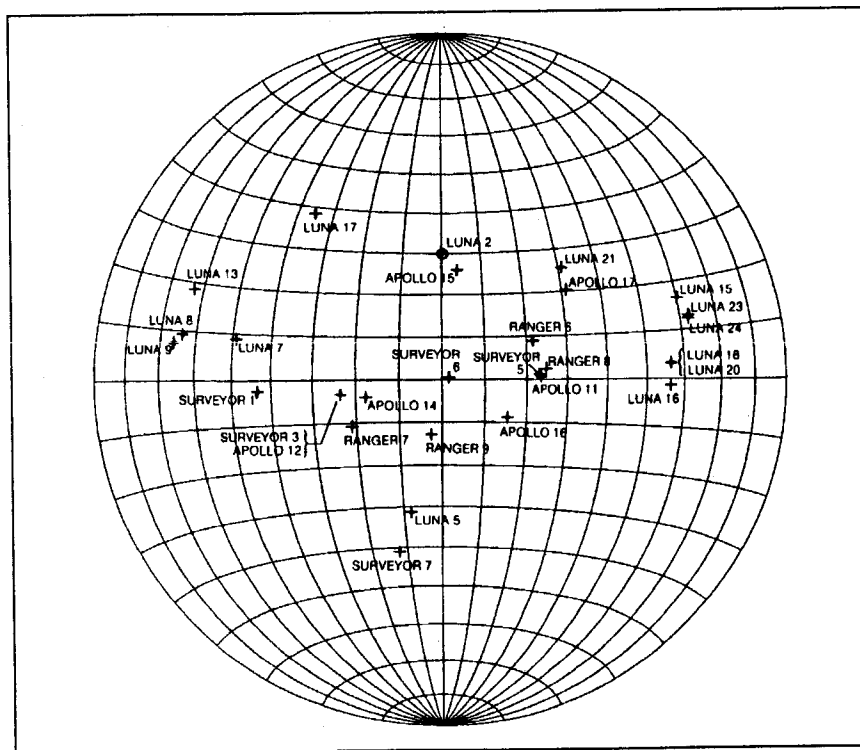

Figure 4.0-1. Landing sites on the lunar surface (Heiken, Vaniman, & French, 1991).

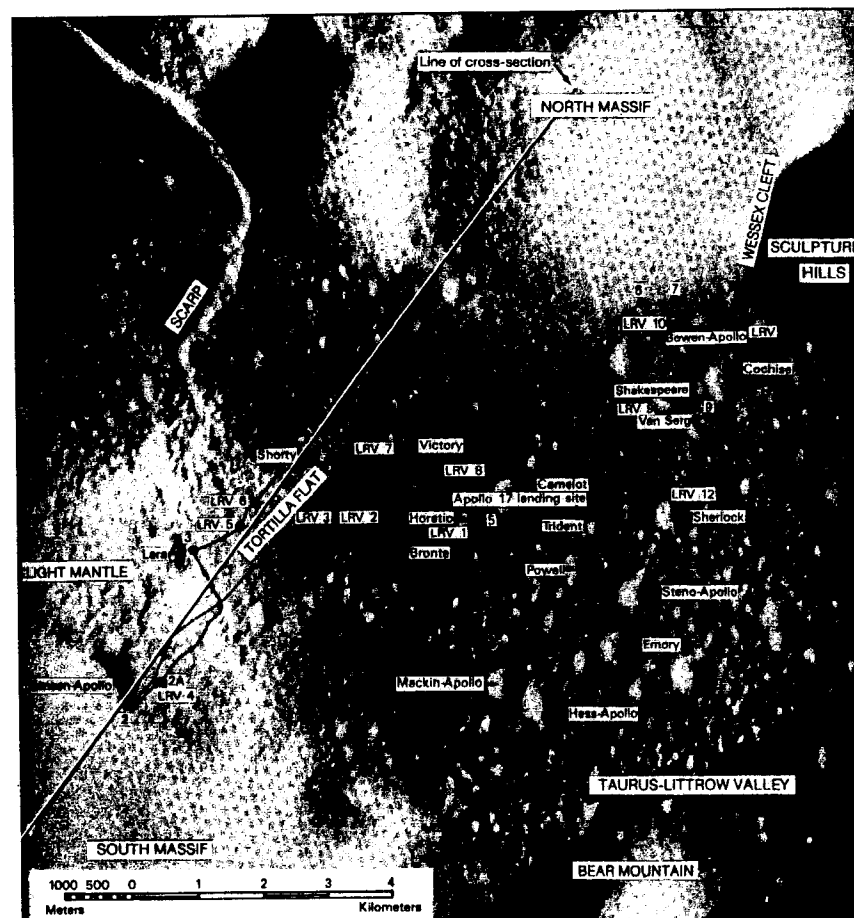

Figure 4.0-2. Apollo 17 Site Traverse Map (Heiken et al., 1992).

Figure 4.0-2 shows the Apollo 17 site traverse map. The solid line indicates the known travel path; the dotted lines are estimated pathways. The cross-section line is shown in Figure 4.0-3 and indicates the results of the lunar geologic processes. The traverse map shows a variety of geologic formations and materials. The cross-section further delineates the complex boundaries between the older highlands and younger mare basalt flows (the numbers indicate samples returned) (Heiken, Vaniman & French, 1991).

Problematic issues concerning lunar surface missions are intense radiation, meteoroid impact, great temperature extremes and regolith

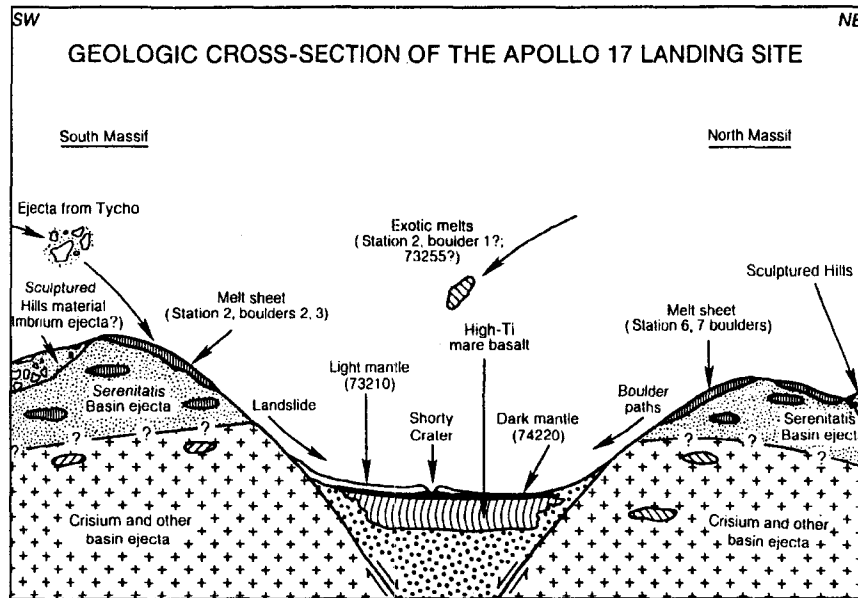

Figure 4.0-3. Cross-section of geologic region of Taurus-Littrow Valley (Heiken, et al, 1991).

(dust) contamination. The radiation penetrates the surface having permanent, distinct, and depth-dependent effects (Heiken, et al., 1991). The depth of penetration ranges from micrometers to several meters. Solar wind ions can penetrate the surfaces of grains and are thought to be the source of certain volatile elements. The heavy nuclei in GCR's and resultant neutrons in the regolith necessitate the use of shielding for humans and equipment.

Figure 4.0-4 illustrates major impact basins on the Moon. These areas continue to assist scientists in the determination of the Moon's origin. They also suggest a portion of the historic chain of events. Table 4.0-5 indicates seismic events. These experiments over a several-year period have recorded over 1700 meteoroid impacts. Of those, 95 are considered major events (Heiken, et al., 1991).

Temperature extremes ppose concerns for human life as well as material and experiment survival. Surface temperature estimates are exhibited in Table 4.0-6. At the Taurus-Littrow site, the temperatures fall into a middle latitude range. At the Apollo sites, the mean temperatures recorded below the surface (at 35 cm) are 40-45 K above the temperatures at the surface (Lanseth & Keih, 1977 as cited in Heiken, et al., 1991).

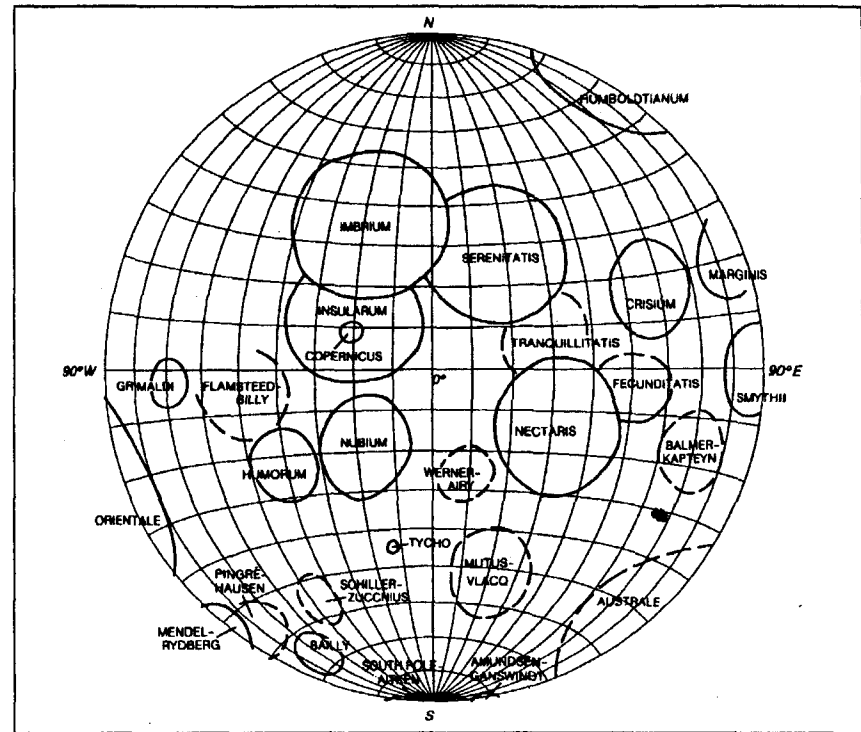

Figure 4.0-4. Impact basins on the Moon's surface (Heiken, et al., 1991).

Period of Observation

1 station (July-August, November 1969 - February 1971)	1.27 yr
2 stations (February 1971 - July 1971)	0.48 yr
3 stations (July 1971 - April 1972)	.73 yr
4 stations (April 1972 - September 1977)	5.44 yr
Total	7.92 yr

Number of Seismic Events Detected

	Total	Major Events
Artificial impacts	9	5
Meteoroid impacts	1700	95
Shallow moonquakes (HFT)	32	7
Deep moonquakes		
confirmed	973	9
unconfirmed	1800	2
Unclassified events	7300	0
Total	11,800	118

Fig. 4.0-5. Lunar seismic experiment recordings (Heiken, et al., 1991).

	Shadowed Polar Craters	Other Polar Areas	Front Equatorial	Back Equatorial	Typical Mid-Latitudes
Average Temperature	40 K	220 K	254 K	256 K	220<T<255 K
Monthly Range	none	±10 K	±140 K	±140	±110

Fig. 4.0-6. Lunar surfact temperature estimates (Heiken, et al., 1991).

Thermometers emplaced 80 cm below the surface have recorded no day/night cycle temperature change influence.

Dust contamination causes concern for sensitive scientific equipment, spacecraft components and human life. Astronaut Alan Bean and his fellow crewmembers reported great amounts of dust floating in the spacecraft cabin post-liftoff. "This dust made breathing without a helmet difficult, and enough particles were present in the cabin atmosphere to affect our vision. The use of a whisk broom prior to ingress would probably not be satisfactory in solving the dust problem, because the dust tends to rub deeper into the garment rather than brush off" (Bean, et al., 1970, as cited in Heiken, et al., 1991). Necessary protection of any item on the surface was further necessitated by the examination of the Surveyor 3 robotic lander during Apollo 12. Discoloration, dust accumulation, and pitting damaged the lander and optical mirror. "Sandblasting" effects occurred from the Apollo 12 landing module (LM) exhaust gases. Apollo 12 landed 183 m away from Surveyor 3.

The Apollo 17 site selection, at 20.2 degrees North latitude and 30.8 degrees E longitude, possesses great potential for further mission and surface operations. Given the information from recorded Apollo missions and the greater amount of knowledge regarding the locale, it was chosen for consideration for *Domus I* and *Dymaxion*.

5.0 DOMUS I: PROPOSED LUNAR HABITAT AND RESEARCH FACILITY

5.1 MASTER PLAN AND CONSTRUCTION SEQUENCING

5.1.1 FIRST LUNAR OUTPOST (FLO)

In response to requirements like those above in Section 2.2, both the Exploration Program Office at NASA/JSC and the USRA Advanced Design Program at the University of Puerto Rico (UPR) have developed schemes for FLO.

We have chosen to incorporate the UPR FLO scheme for several reasons:

- it is based on the strengths and limitations of the NASA/JSC scheme
- it pays particular attention to human factors in its design
- it proposes some interesting ways of handling radiation protection/safe havens for short duration stay-times without regolith covering

The scheme, figure 5.1.1-1, is a vertical pressure vessel habitat designed to be integral with the FLO lander, in fact the habitat is embedded within the lander legs and fuel and oxygen tanks rather than being a horizontal habitat resting on top of the lander legs and fuel tanks as in the earlier NASA/JSC scheme. This arrangement provides some radiation protection for the habitat and research spaces. The safe haven is the second lowest level of the habitat.

FLO is divided horizontally into four floors. The lowest level is the airlock and ingress/egress module. The second level is the crew quarters, double-functioning as a safe haven. The third level is the research level. The top level is the crew support facility.

While this scheme has some limitations (e.g., awkward zoning from public entry to private crew quarters to semi-private work spaces to public recreation spaces), it has the distinct advantages of being protected by the structure and tanks of the lander and providing a natural safe haven. With the proximity of the FLO module (s), the astronauts will have the capacity to reside in FLO while conducting the construction of *Domus I*.

5.1.2 INTERMEDIATE PHASES

With FLO established, the process to construct the initial operating configuration (IOC) begins. This intermediate phase has yet to be closely examined. The aerospace industry is in the process of identifying the equipment necessary to construct the final configuration of the lunar base. At this point, we suggest only that an intermediate phase will occur bringing additional crewmembers to oversee the construction.

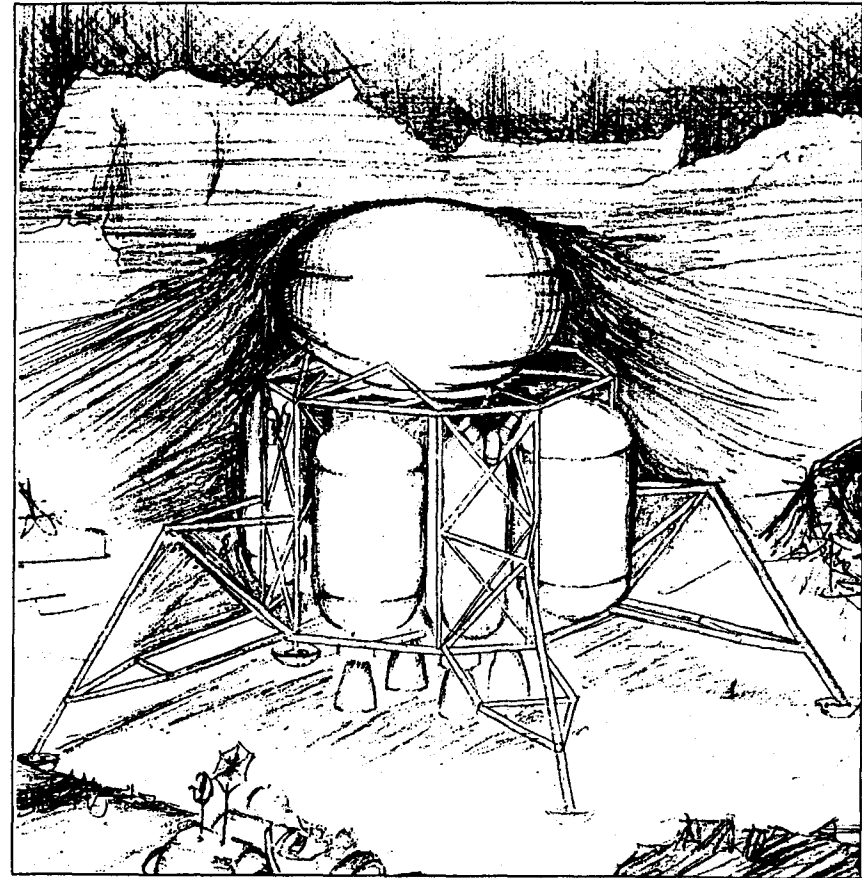

Figure 5.1.1-1. First lunar outpost concept sketch (University of Puerto Rico, 1992).

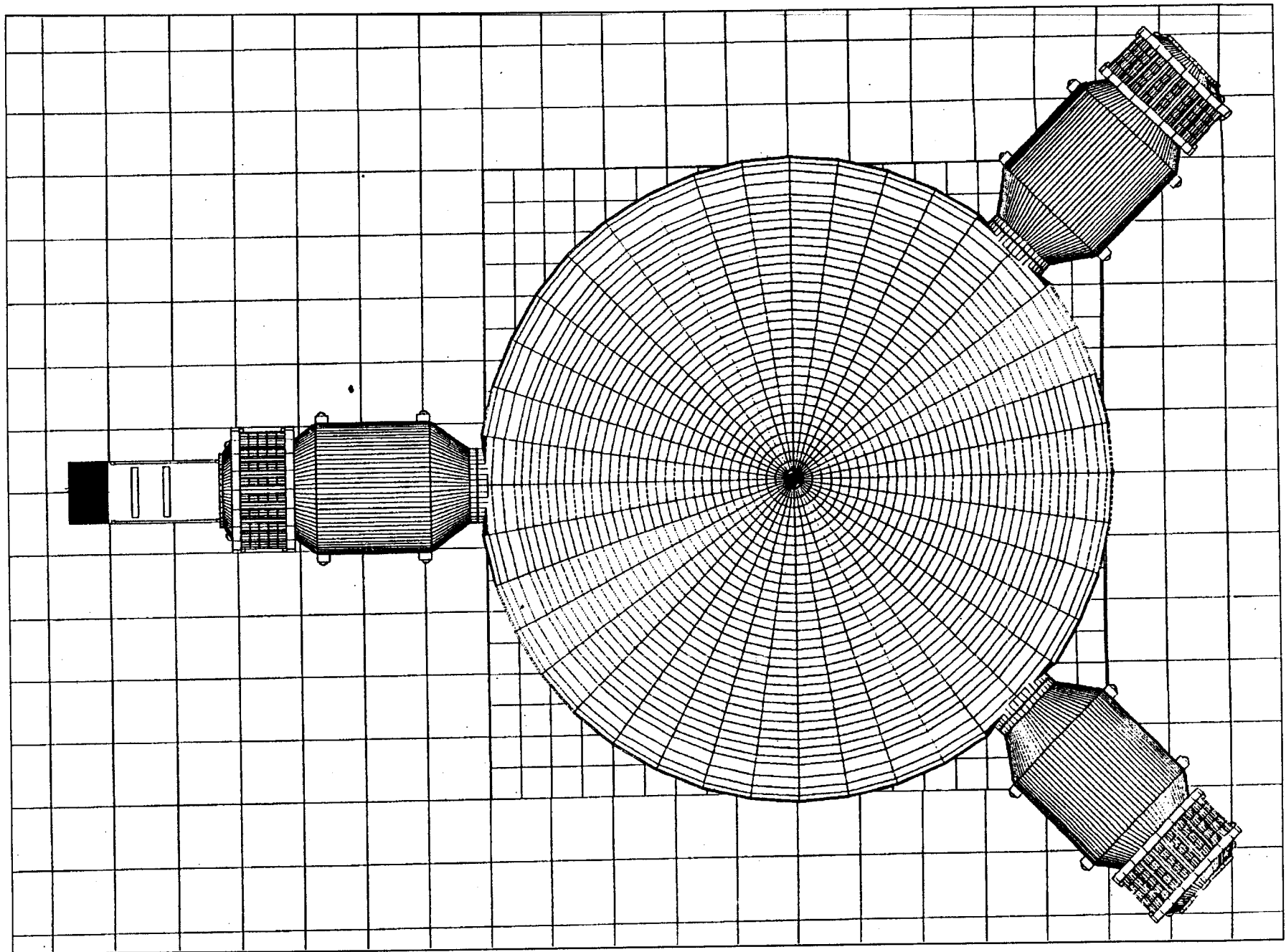

Figure 5.2.1-1. Exterior plan of Domus I shown without protection system.

5.13. INITIAL OPERATING CONFIGURATION (IOC)

The Initial Operating Configuration (IOC) will be achieved with the outfitting of all interior spaces of the PSMSS system concept suggested by Chow & Lin (1988).

After inflation and hardening of the rigidized foam, the entire structure will be depressurized, allowing easy movement of partitions, equipment, and furnishings into the habitat and research areas. Wall partitions, mechanical systems, hatches, scientific equipment, and all other equipment and furnishings for the research spaces, mission control, crew quarters, and crew support facility will be moved into the torus and inflatable, deployed, and put into operation mode. Once completed, the three major ingress/egress hatches will be closed and the entire structure repressurized, this achieving IOC.

5.2 INITIAL OPERATING CONFIGURATION

5.2.1 DESIGN ORGANIZATION OF THE HABITAT/RESEARCH FACILITY

The habitat will be organized as the center of a linear base master plan. This central habitation zone will consist of the habitat itself, the solar collection field, and the FLO module. There are two major component types that comprise the habitat. These include the pressurized and rigidized ellipsoid geometry, and three airlocks. The primary airlock will have a dust-off entry system. The remainder of the airlocks, positioned to provide egress capability from the torus, have rover docking collars. Each can be used for human egress in the event of emergency without a rover docked to it.

The ellipsoid geometry houses research and crew functions. Within the ellipsoid, a torus houses the laboratories to support mission directives. Human and physical sciences will occupy the entire torus. Each laboratory specific to the sciences have the capability of individual lock-down. Entrance points into the interior of the ellipsoid, the domed area, are located opposite each other in two areas. The torus has been designed as a single-floor structure. The domed portion has been designed as a two-floor facility, separating functions addressing crew support and crew quarters (Figures 5.2.1-1, 5.2.1-2, and 5.2.1-3).

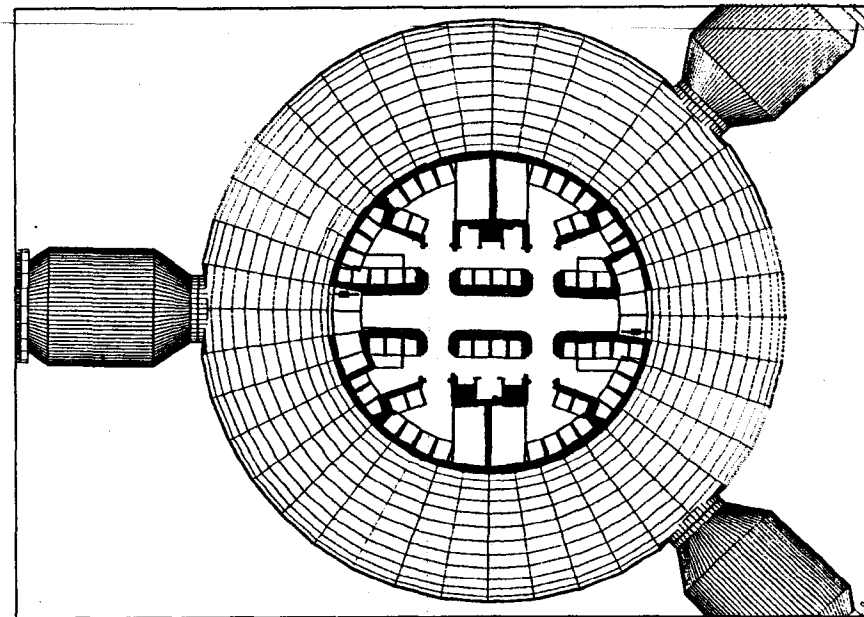

Figure 5.2.1-2. Floorplan of Domus I with lower level of dome illustrating the crew quarters and hygiene facility.

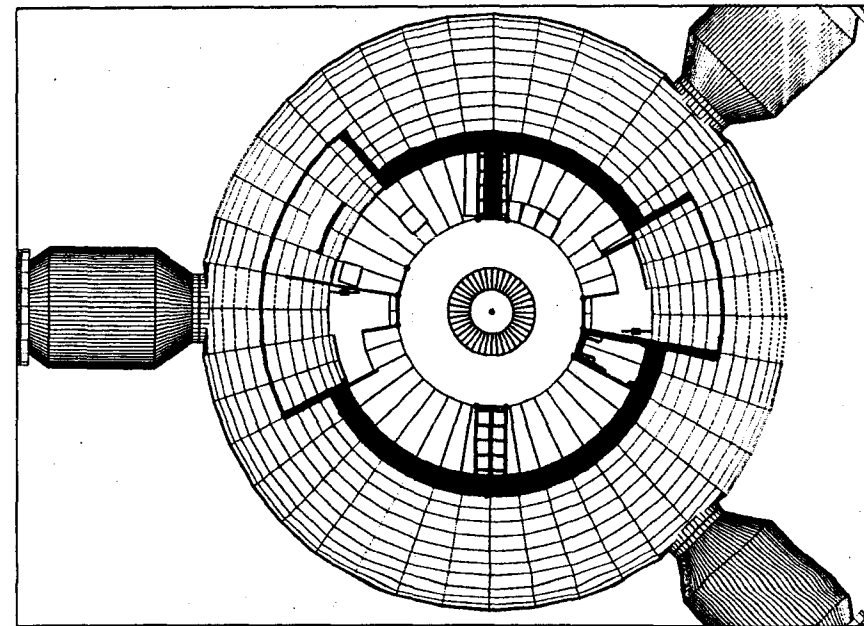

Figure 5.2.1-3. Floorplan of Domus I with upper level of dome illustrating the crew support facility.

5.2.2 BUILDING SYSTEM

5.2.2.1 Materials

Domus I required a shielding system, an inflatable envelope component, and structural foam. The use of in situ materials provided the advantage of saving weight and materials for launching from Earth. The shielding was accomplished using the lunar regolith. The bulk density of regolith increases with depth, and below 10-20 cm, the soil is often a higher density than is required to support the over burden of the lunar gravity (Carrier, Mitchell, & Mahmood, 1973). A predetermined areas has been dedicated to excavation of regolith for the shielding.

The collection method for the regolith required screening for large particles that might damage the inflatable structure. Lunar silicates may possess very high strengths due to an "anhydrous strengthening" effect relative to our common experience on Earth.

Fusion of the top layers of lunar soil focused sunlight to form a magma - lava crust - to arrest unstable lunar dust. Spacecraft landing pads and vehicular roads are prime examples for the use of this technique. A device to accomplish this task will use on-spot fusion of the top layer to a desirable depth. Outright melting would not be required because the dust particles agglomeration via sintering could be expected to occur well below melting.

The inflatable exerts a uniform pressure and created a prime opportunity for tensile strength application. The inflatable envelope will consist of a high strength multi-ply fabric (e.g., Kevlar 49) with an impermeable inner layer and a thermal coating on the exterior. Loading on the inflatable structure consists of:

- internal pressure selected to be 101.4 kPa
- dead loads on the inner and outer structures
- thermal stresses due to extreme temperature ranges
- internal motion

The structural foam used in the rigidizing of the inflatable would be injected. Current technology does not have definitive data on the results of rigidizing foam in a vacuum. The final quality of the foam is at question. The density and configuration of the foam will determine whether it can withstand the live loading for spans of up to 20 years. One advantage of utilizing foam is the transportation ease. It can be delivered to the lunar

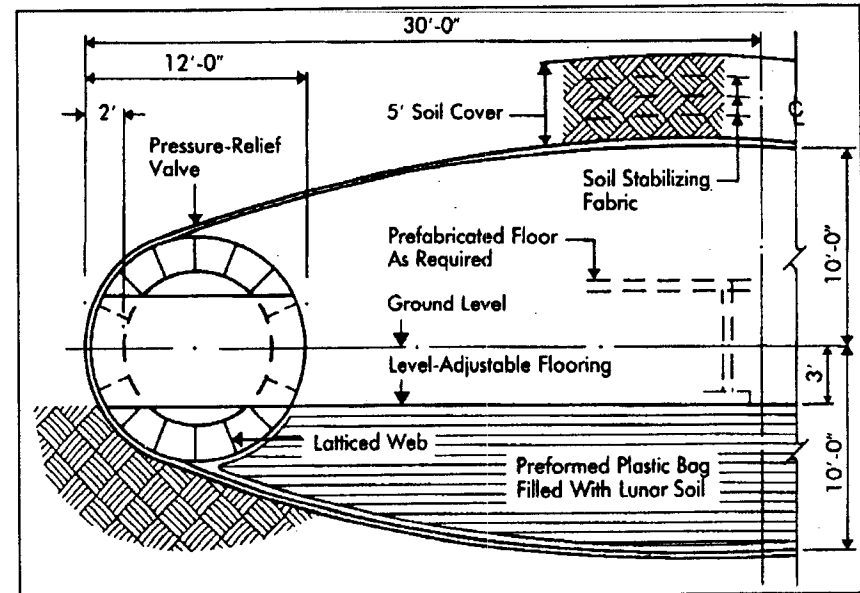

Figure 5.2.2.3-1. Pressurized self-supporting structural system (Chow & Lin, 1988).

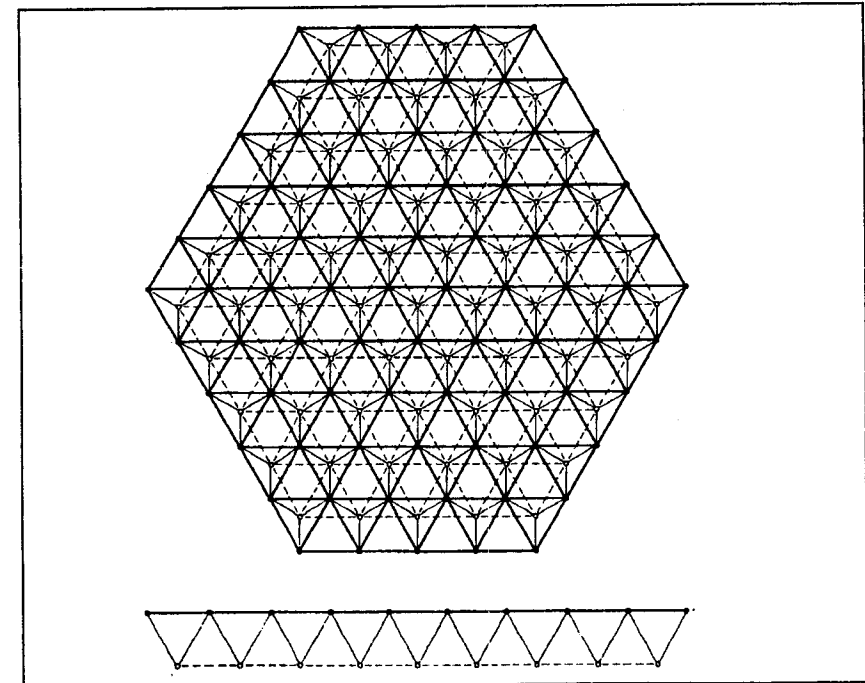

Figure 5.2.2.3-2. Meroform M12 construction system (Meroform-Raumstruktur)

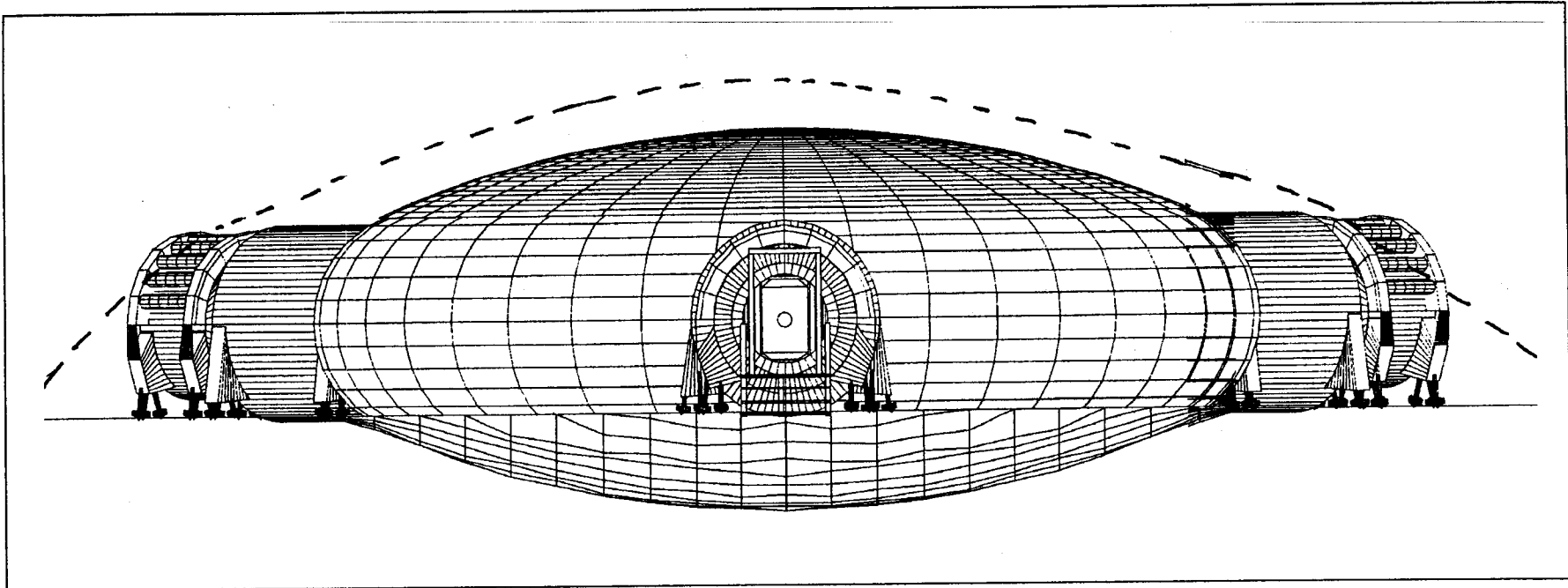

Figure 5.2.2.4-1. Computer illustration of regolith shielding emplaced over the habitat structure.

surface compressed into tanks.

5.2.2.2 Construction System

The equipment will move the module that houses the habitat. It will then supply power from two possible sources — electrical and mechanical. Deployment of the inflatable habitat will primarily be independent, lessening the possibility of accidental puncture and the difficulty of accomplishing the connections. Once the habitat is inflated and rigidized, the airlocks will be docked and secured, all three being appropriately covered.

Construction of the internal components will commence once payloads have been delivered to the surface. EVA time will be necessary to deliver a portion of the components. The balance of the interior construction can be accomplished in a shirt-sleeve environment.

5.2.2.3 Structural System

The strength of Domus I lies within the structure as a whole. The geometry allows this unique ellipsoid shape to work well pressurized in a vacuum environment. Each component of the structure provides strength, much like the current space shuttle utilizes its rack system to add structural integrity (Figure 5.2.2.3-1).

The flooring system utilized a modular component concept, for supports, bearings and bases. This spaceframe system is linked to the substructure and stabilized by means of supporting and bearing system. The type of support or bearing structure was dependent upon the criteria of function, design and site conditions. The framework supports are regarded as the ideal construction. They have the ability to absorb both vertical loads and lateral shearing forces. Furthermore, they can be assembled from modular systems components, therefore a special construction is not required. The diagonal reinforcement can be replaced by a rigidly inserted, sturdy panel element (Meroform-Raumstruktur, 1983) (Figure 5.2.2.3-2).

5.2.2.4 Shielding

The utilization of lunar regolith will protect the habitat from the effects of hazardous radiation. Thermal protection will also be a benefit of the regolith that will be piled onto the exterior of the inflatable envelope. A suggested depth of 2 m will provide the radiation shielding, and this suggested depth has been determined to control the heat loss and gain in cylindrical models. The method of deploying the regolith must be a gathering, raising and covering technique, allowing for the natural slump angle of regolith.

5.2.3 TECHNICAL SYSTEMS

5.2.3.1 Computer System

Based upon all the requirements cited for the selection and design of the computer, an IBM AP-101 will be used for *Domus I*. Each General Purpose Computer (GPC) is composed of two separate units, a central processor (CPU) and an input/output processor (IOP). These are referred to as the GPC's main memory.

The central processor controls access to GPC main memory for data storage and software execution and executes instructions to control the base systems and manipulate data. In other words, the CPU is the "number cruncher" that computes and controls computer functions.

The IOP formats and transmits commands to the base systems, receives and validates response data from base systems and maintains status of interfaces with the CPU and the other GPCs.

During the receive mode, the multiplexer interface adapter validates the received data (notifying the IOP control logic when an error is detected) and reformats the data. During the receive mode, its transmitter is inhibited unless that particular GPC is in command of that data bus.

During the transmit mode, a multiplexer interface adapter (MIA) transmits and receives 28-bit command/data words over the computer data busses. When transmitting, the MIA adds the appropriate parity and synchronization code bits to the data, reformats the data, and sends the information out over the data bus. In this mode, the MIA's receiver and transmitter are enabled.

The main memory of the GPC is non-volatile (the software is retained when power is interrupted). The memory capacity of each CPU is 81,920 words, and the memory capacity of each IOP is 24,576 words; thus, the CPU and IOP constitute a total of 106,496 words.

Each GPC power on, off switch is a guarded switch. Positioning a switch to on provides the computer with triply redundant power (not through a discrete) by three essential busses—ESS1BC, 2AC and 3AB—which run through the GPC power switch. The essential bus power is transferred to remote power controllers, which permits main bus power from the three main busses (MNA, MNB, and MNC) to power the GPC. There are three R/C's for the IOP and three for the CPU; thus, any GPC will function normally, even if two main or essential busses are lost.

Each GPC can receive a discrete signal for run, standby, or halt. The mode switch is lever-locked in the run position. The halt position for a GPC initiates a hardware-controlled state in which no software can be executed. The standby mode allows the GPC to be software-controlled but no software may be executed during this state. The standby discrete allows an orderly startup or shutdown of processing.

Also of consideration for using on *Domus I* is the IBM AP-101S. This computer is the upgraded version of the AP-101. It has a memory of 256,000 32-bit words, and has a 6000 hour mean time between failures with a projected growth to 10,000 hours mean time between failure. The AP-101S avionics box is 19.55 inches long, 7.62 inches high and 10.2 inches wide, the same as one of two previous GPC AP-101 avionics boxes. As well, the power on the AP-101S has been improved from 650 watts to 550 watts of power.

Although the IBM AP-101 was originally suggested for use, the AP-101S could be used in its place. There are advantages and disadvantages which would have to be analyzed for both computers, but it seems that the IBM AP-101S would have far greater advantages.

5.2.3.2 Rack Components

There are three typical rack designs which are composed of interchangeable modular components. Square units have been designed that must fit into a circular envelope. This demands specialized design to accommodate the unique areas on the perimeter of the structure or within the interior volumes. The first two rack designs address the torus shape for the laboratories and work environments—the inner and outer "ring" of

the geometry. Components within the labs have the ability to be retrofit into the interior portion of the habitat. These have been developed to provide maximum stowage yet provide maximum ease of circulation. The third design has modular portions of the first design, yet it is utilized solely over the exposed portion of the torus on the upper level of the dome.

The primary rack design is used in the laboratories, crew quarters, and within crew support. This rack dimension is 2.3 m high, 1.2 m wide and 1.2 m deep. This rectangle is bisected twice, by the width and depth, from the floor to the ceiling. The rear stowage rack components are also bisected into halves, making one identical component. The front rack components are divided into 2 equal units termed mods (mods are a derivative for modular units) horizontally and 8 units vertically. These are designed as interchangeable parts with various different sizes to accommodate the needs required. The design consists of maximum configurations with these mods while maintaining a minimum number of rack parts. The various mods are dimensioned as follows:

- mod 1 x 1 (.6 m x .2875 m x .6 m)
- mod 1 x 2 (.6 m x .575 m x .6 m)
- mod 1 x 3 (.6 m x .8625 m x .6 m)
- mod 1 x 4 (.6 m x 1.15 m x .6 m)
- mod 2 x 3 (1.2 m x .8625 m x .6 m)
- *mod 1 x 4 (.6 m x .8625 m x .6 m)

*this rear mod curves to match the torus configuration

The measurements above have the first units listed as the number of mods in terms of width-horizontal, which can be only 1 or 2; the second number refers to the number of mods within the height-vertical, which range from 1 to 8. (Figure 5.2.3.2-1).

The second rack design is specialized for the configuration of the interior curve of the torus. In order to maximize stowage throughout this interior ring, the racks are sized at 2.3 meters in height. The widths vary to utilize more of the areas as controlled stowage space. By shortening the depth, proper circulation is maintained, as required, throughout the torus ring to enhance laboratory mobility.

The third rack design is used in the crew support facility, located on the second floor of the dome. It is dimensioned at 2.3 m high, 1.2 m wide and 1.2 m deep. The primary goal in this design is to utilize the area over the torus. The top front quadrant of this rack consists of the same mods from

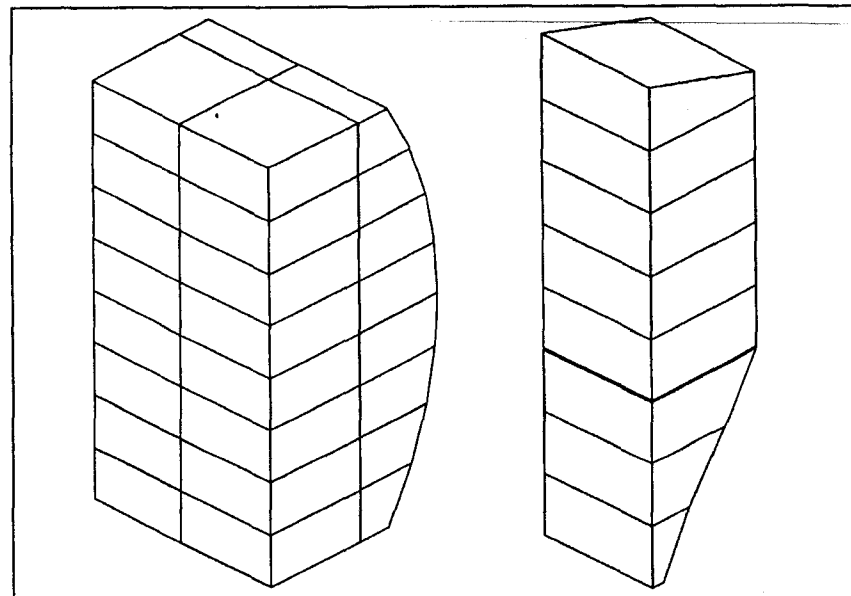

Figure 5.2.3.2-1. Rack component illustration and dimensioning.

the first rack design. The other three quadrant are a new design. It was driven with the intent of maintaining maximum space on the second floor and providing additional stowage.

5.2.3.3 Workstations

There are three basic types of workstations that were designed for Domus I. Each workstation is a derivative of a basic rack. The basic rack was divided into a 2 by 8 matrix so that a standard "kit of parts" could fit into this rack. The command center workstation, the laboratory workstations and the backup workstation utilized this standard matrix for the different parts.

The command center is divided up into three racks. The two outside racks are of similar design while the center rack is different. Each rack has two monitors attached to them. The outside racks contain storage for the GPC mainframe and storage of different materials. The laboratory workstation is two-racks wide. It contains room for the computer memory, keyboard, printer, hard and soft copy stowage, and a table top for writing and calculating (Figure 5.2.3.3.-1).

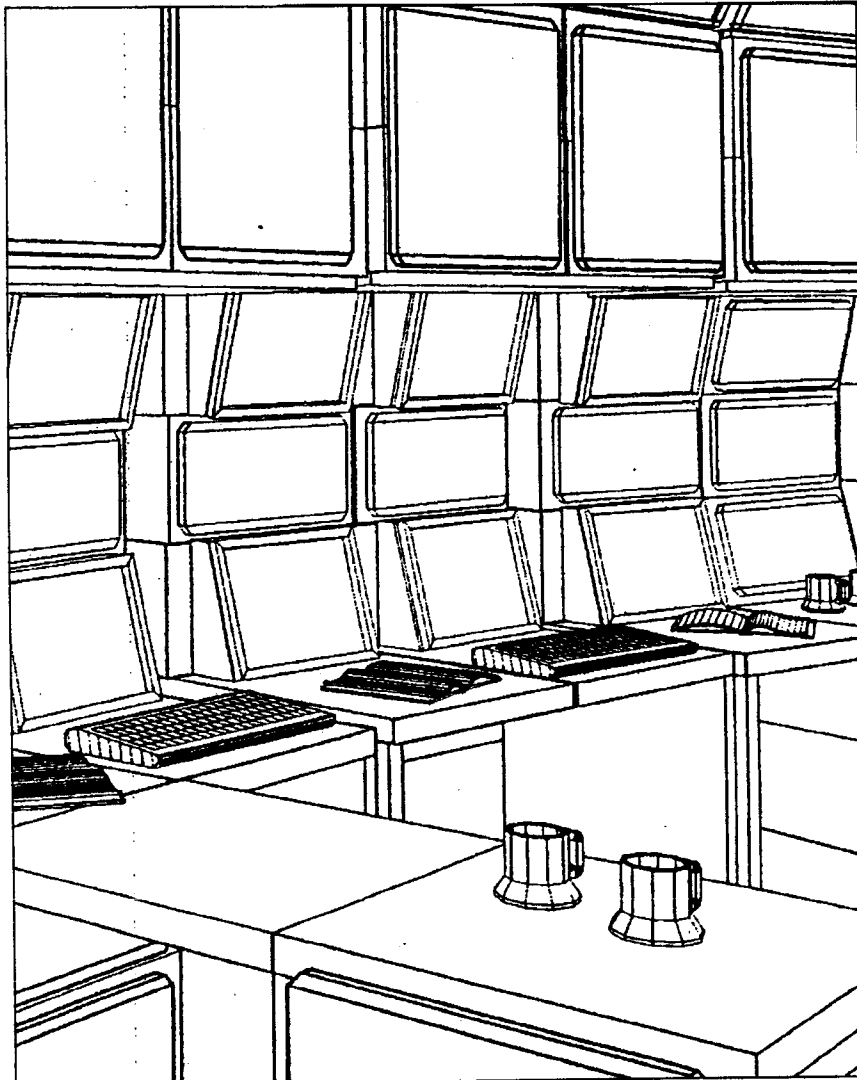

Figure 5.2.3.3-1. Command and communications center in torus portion of habitat.

The backup computer center consists of two monitors, a discrete switch panel, and a keyboard along with memory. This unit fits onto a desk within the crew quarters allowing control of the base from the inside of the Domus I dome in the event of torus failure (Figure 5.2.3.3-2).

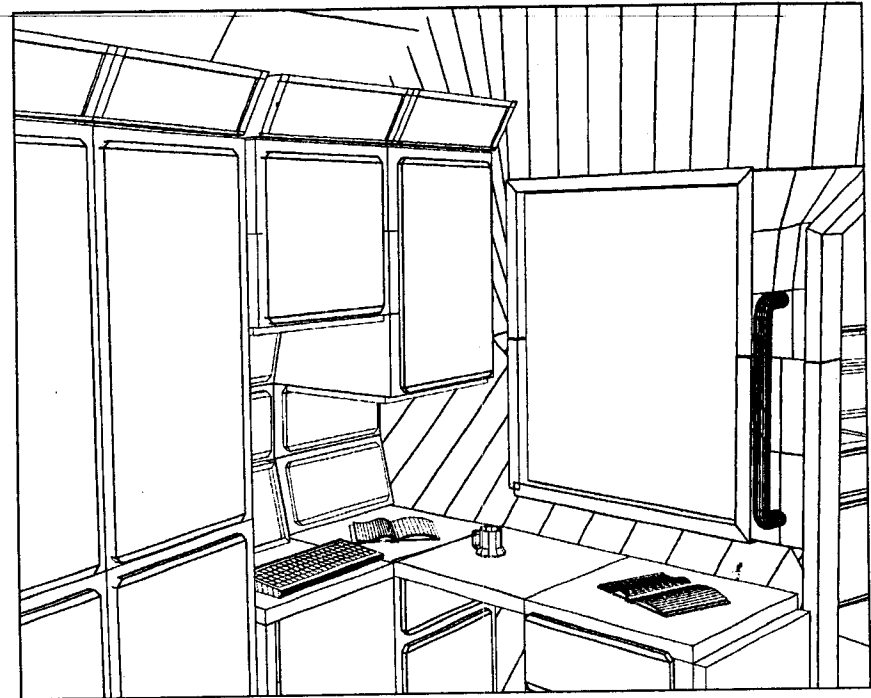

Figure 5.2.3.3-2. Laboratory workstation illustrating computer center.

5.2.3.4 Furnishings and Equipment

Furnishings and equipment will have an impact on the productivity as well as the aesthetic values of the users. Functional issues addressed making the units compact, interchangeable, lightweight, and modular. The components developed serviced the following areas and functions within the habitat:

- torus: limited hygiene facility, suit stowage and desks, workstations, and countertop areas
- dome portion — lower floor: desks with computer communications, caution and warning systems, shelving units, closets, hygiene with hand/face, eye washing capability
- dome portion — upper floor: refrigerator, microwave, dishwasher, washer/dryer, stowage, exercise countermeasure equipment, occasional tables

Additional furnishings that were independent of the component system were the beds, chairs, hand holds, and the wardroom table. These

units were either mobile or needed exceptional dimensioning due to their location within the habitat. The beds were designed to maximize comfort and could be manipulated to adapt to the physical form of the body. The beds can fold under the head, at the lower back location, and underneath the knees (Figure 5.2.3.4-1).

The chairs were designed for maximum adjustability. The design included for Domus I addresses the anthropometric proportioning for the 5th percentile female to the 95th percentile male. The chair consists of a fluid design that supports the buttocks, knees and feet. Added components can alter the chair's use — armrests and back supports can be attached (Figure 5.2.3.4-2).

The wardroom table has the capability of seating 4 to 6 to 12 crewmembers. Portions of the table can be removed and stowed into floor compartments. This flexibility allows a wide range of table configurations, leading to a variety spatial arrangements for meeting, eating and casual or more formal communications (Figure 5.2.3.4-3).

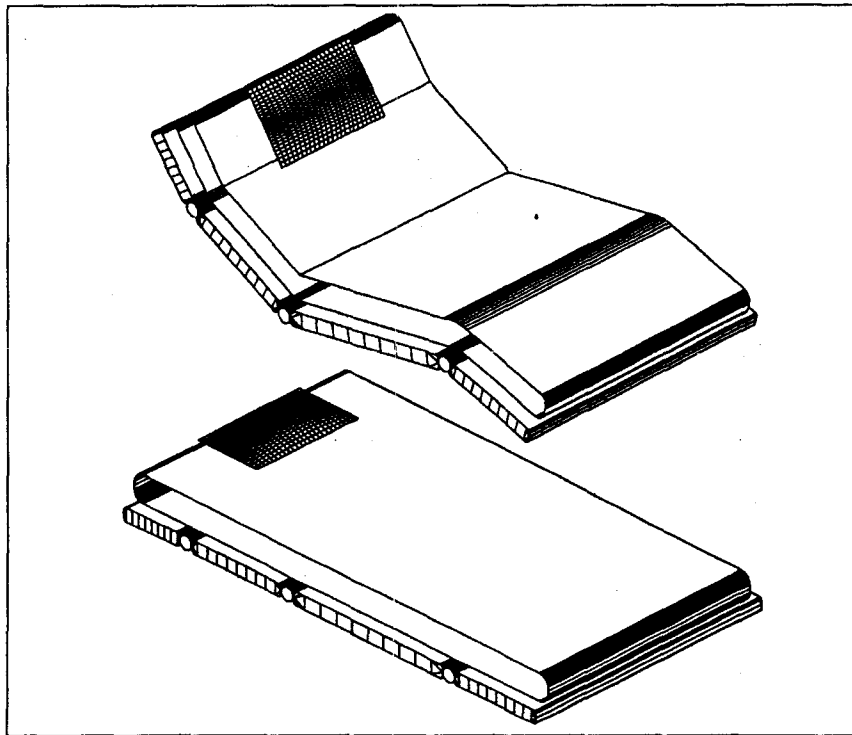

Figure 5.2.3.4-1. The sleeping quarters contain an adjustable bed allowing the crew member flexibility in comfort.

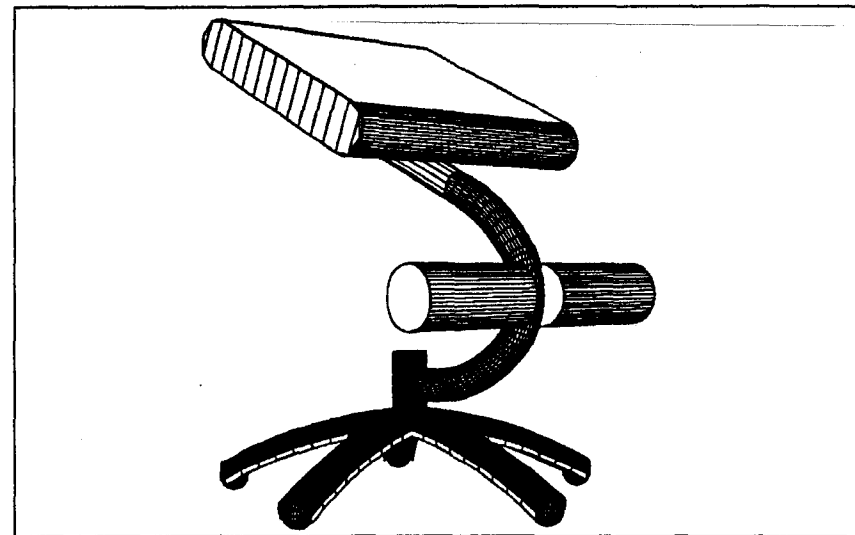

Figure 5.2.3.4-2. Tubular chair designed for multi-use within the habitat.

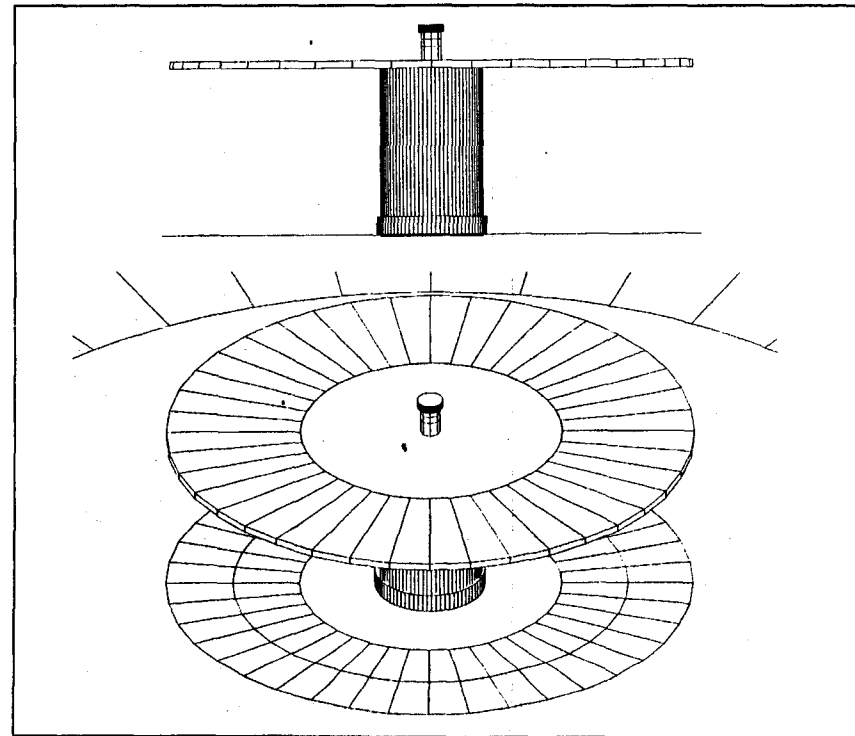

Figure 5.2.3.4-3. Wardroom table fully deployed.

5.2.3.5 Interior Materials, Colors, and Finishes

The structural components of the interior of the habitat have been designed from a metallic alloy material. Surfaces and interior workstation and stowage components will be constructed from a lightweight material. This material will not outgas and cause problems which may lead to a toxic environment. They provide minimal maintenance with easy cleanability, are nonflammable, and are interchangeable with other like components within the habitat. The materials will also resist scratching, abrasion and will resist damage inflicted by a corrosive contaminant.

The color use suggested differs within the dedicated spaces of the habitat. For the laboratory environments, Earth-based color palettes were selected with the lightest value of the color used in the main structural components. For small components and panels, critical rack drawers or controls, bright, eye-catching colors complimenting the palette were chosen. Each laboratory followed a prescribed scheme. Each adjacent space had a visual connection between them. As this environment is confined spatially and visually, the colors did not change abruptly. Colors flow and blend throughout the torus laboratory spaces. At key hatch locations, the windows designed opened the visual environment into the adjacent space, even if the hatches were sealed. The "backdrop" of the facility, the ellipsoid envelope, is a light, unobtrusive color that readily blended with each color palette. The floor of the torus was simply a darker value of the same envelope color.

Within the crew quarters spaces, flexibility was given to the crew in the selection of rack door and drawer panel colors. Simple reversal of the panels will allow the crewmember to change color schemes at any time. Walls and floors were given a light-valued tone to prevent the narrow spaces from "closing in" visually. Bright color was added to the emergency control panels on the walls and to the overhead doors that provide privacy for each quarter, yet are completely stowed when not in use. This bright color coordinated with the chair color selected for use throughout the habitat, and provided an architectural delineation for the quarters entrances.

The crew-support floor above the quarters maintained a single color scheme throughout all the functional areas. The base components were all of the same color; floor and wall surfaces of the envelope coordinated with the torus color. Each functional area then had its own distinctive complimentary palette added to the base color. Bright color usage was

kept to a minimum, except where necessary critical functions were highlighted. With the use of a base palette and selective color compliments, the visually confining environment would appear more spacious. Again, color flow movement from space to space provides a more even "feel" to the volume.

The finishes chosen for all horizontal surfaces would not cause a reflectance problem. Matte or satin finishes for vertical surfaces aid in illumination. The finished surface is one area where visual stimulation can be achieved. It was recommended that textures be placed in key locations that would be seen at all times by the crewmembers. Again, the ability to changeout the textural patterning is desirable.

5.2.3.6 General Illumination

Five distinctive types of lights have been designed for use in the lunar habitat. These include:

- rack lights
- built-in lighting
- puck lights

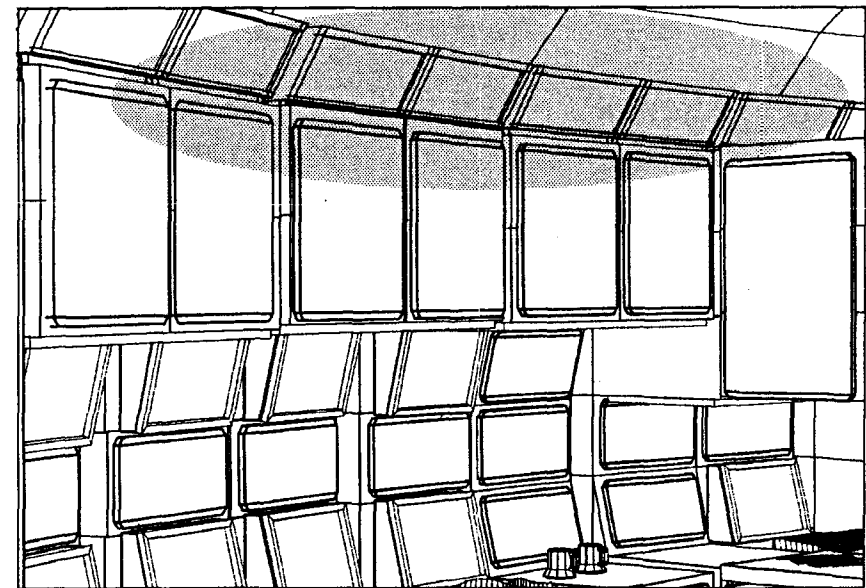

Figure 5.2.3.6-1. Rack lighting system installed above the rack components in the torus.

- swivel lighting
- flexible lamps

The rack lighting system is a multi-functioning unit, was designed to fit into the standard rack configuration. It provided indirect or direct lighting. Curved mirrors inside the top section may direct light along the ceiling when the unit is used for indirect lighting situations. For direct lighting, the front opaque panel may be removed to reveal a translucent panel beneath (Figure 5.2.3.6-1).

Built-in lights are placed in the racks over the desks in the labs and in the crew's quarters. They were not utilized in the crew support area due to the reduced desk height. To compensate for this design difference, railings similar to the bounding platform railings run between the columns and continue above the desks. The rails support 6 flexible lamps that illuminate the desk surfaces (Figure 5.2.3.6-2).

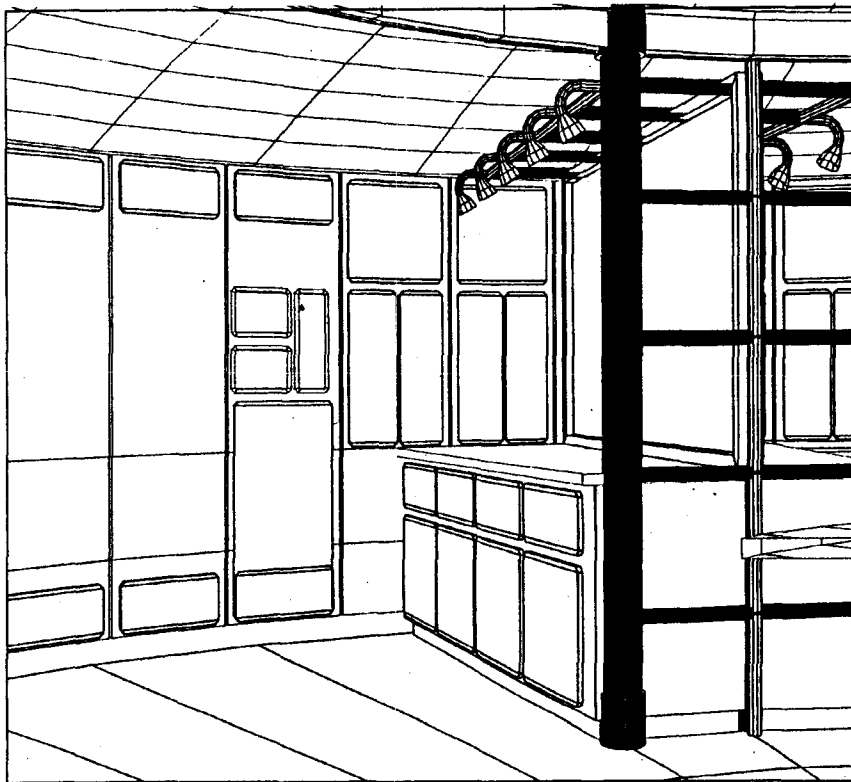

Figure 5.2.3.6-2. Flexible lighting illuminates the desk surfaces.

General illumination on the upper level of the crew support facility uses the puck light design. The inflatable structure makes recessed lighting in the exposed ceiling of the upper level impractical. The puck lights are small and can be attached to the surface of the ceiling. Power is supplied with thin wires painted the ceiling color. Halogen lights are suggested for their compactness and long life.

A special puck light, the swivel light, is also easily mounted. These fixtures have a hemispherical cover and optics that direct the light. The fixture is mounted on a place that allows the swivel movement.

Specifically within the habitat the following lighting system and combinations have been implemented:

- torus: rack lights, desk lights and medical lighting
- dome, lower floor:
 - quarters: rack lights, desk lights, wall-mounted bed lights;
 - translation pathway: ceiling lighting, and wall lighting;
 - hygiene: toilet and shower lights, mirror lights, rack lights;
 - bounding platforms: stair puck lights, railing lighting
- dome, upper floor:
 - wardroom: circle room light, ceiling pucks, built-in table light, column up-lighting
 - galley: ceiling swivel lights, desk lights, rack lights
 - recreation: ceiling swivel lights, desk lights
 - library: ceiling swivel lights, desk lights, rack wall washing lights
 - exercise: ceiling swivel lights desk lights

5.2.4 ENTRANCE/EVA MODULES

The chosen configuration is a dual-chamber airlock. Although larger in size, efficiency renders it cost effective. The airlock will be equipped with the latest technologies available at the time of construction. One enters the airlock from the habitat through a hatch; this hatch will be kept closed to reduce the area life support must maintain. Life support is fed into the airlocks through connections in the floor (Figure 5.2.4-1).

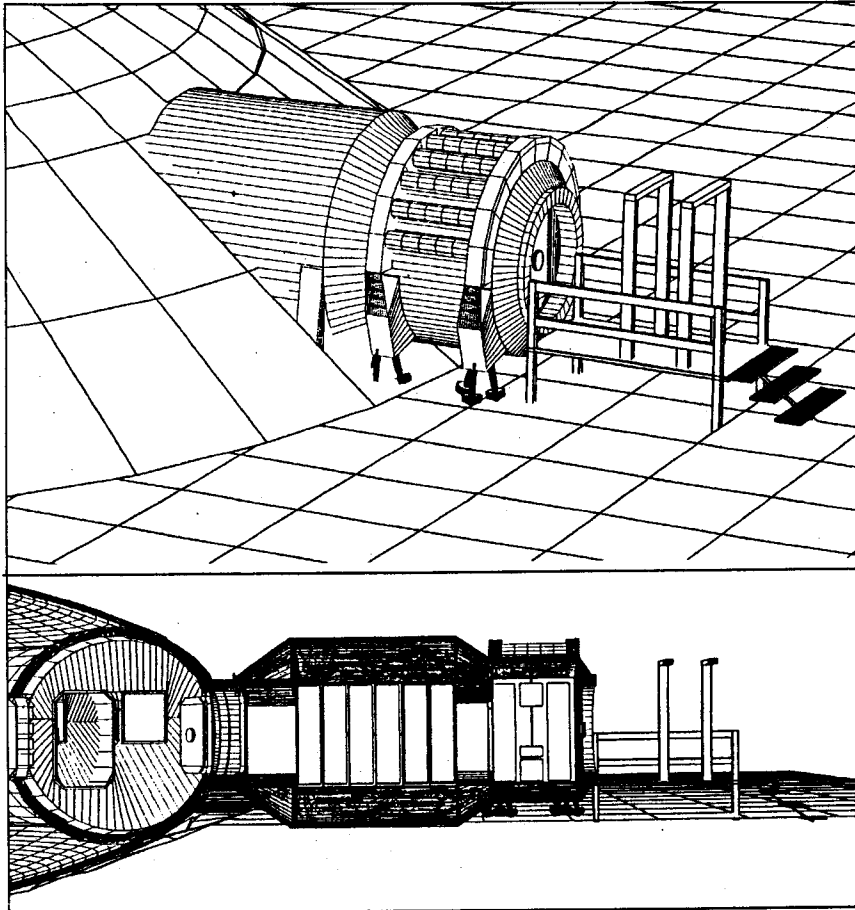

Figure 5.2.4-1. EVA module and airlock support structure.

Airlocks will, for safety reasons, be able to self-support for longer periods of time in the event of habitat failure. EVA equipment is stored in six racks located in the number one air chamber. It is here that donning and doffing of the EMU will take place. Maintenance and other related functions are done in chamber one as well. These anticipated uses of the airlock, other than ingress and egress, are equipment transfer, hyperbaric treatment facility, dust removal and a safe haven. All three airlocks provide all the functions except as a hyperbaric chamber. In the event of emergency requiring more than one chamber to function as a hyperbaric environment, the remaining airlocks can function as reduced pressure vessels.

Dust contamination abatement will be controlled by electrostatic wickets at the entrance to the airlock. These will reverse the electrostatic charge of the regolith, allow the particles to drop away from materials, equipment and garments. A collection system will then confine the particles and prevent them from entering into the laboratories or habitat.

5.2.5 TORUS: RESEARCH LABORATORIES AND MISSION CONTROL

Not only is the torus used as the major structural member for the base, but the space created within the torus offers a functional and usable space. This space is used for the research laboratories and mission control because the interior of the torus offers a completely different architecture than inside the dome thus offering a strong separation from work and home (Figure 5.2.5-1).

The interior curve of the torus walls is compatible with Space Station Freedom type racks thus this technology is adopted for the walls and floor offering ample stowage space.

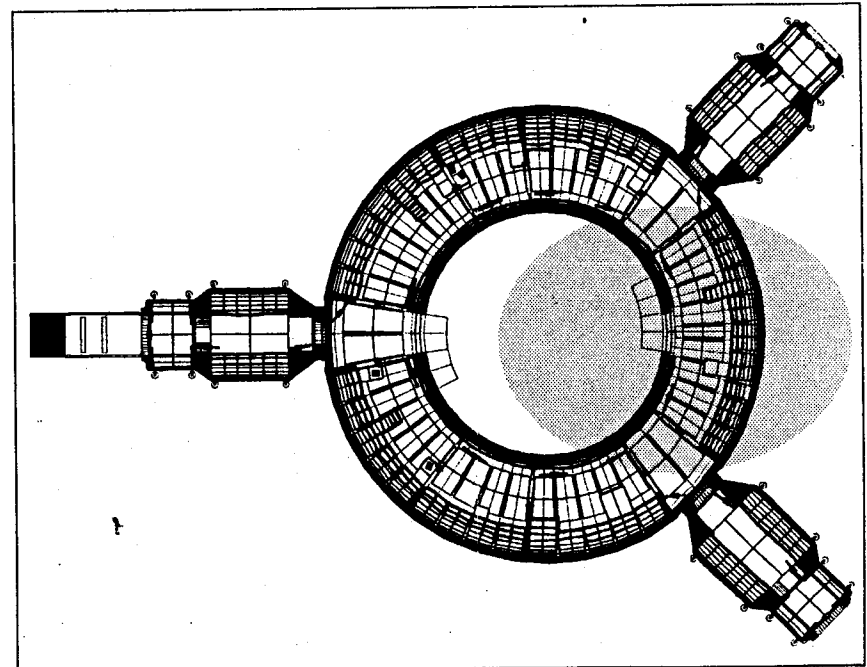

Figure 5.2.5-1. Floorplan of Domus I research laboratories.

The ceiling, for the most part, is left exposed. This breaks the box effect of the labs and offers a barrel vault for both esthetics and optical relaxation. The health maintenance facility (HMF) and the EVA backup chambers make use of Space Station Freedom-type racks in the ceiling for extra stowage and ease of cleaning.

Bulkheads have been designed into the torus to be used as emergency dividers and to break up the constant curve of the torus. Likewise, windows have been designed into the bulkheads to allow for previewing and distance viewing.

5.2.5.1 Research Laboratories

The torus is divided into three functional crescents which in turn are separated with an EVA module thus allowing each crescent two means of egress. The laboratories are separated into the crescents by function and similarity. The Human Sciences crescent contains the Microbiology Lab, the Life Sciences Lab, and the Health Maintenance Facility. The Physical Sciences crescent contains the Geomorphology Lab, and the Botany Lab and Plant Growth Chamber.

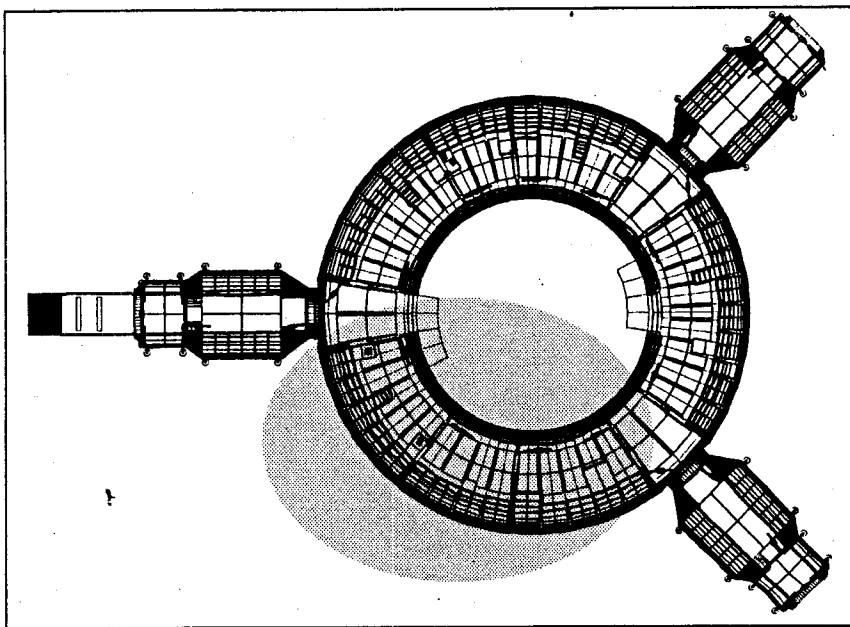

Figure 5.2.5.1.1-1. Human sciences crescent houses microbiology lab, life sciences lab, and the health maintenance facility.

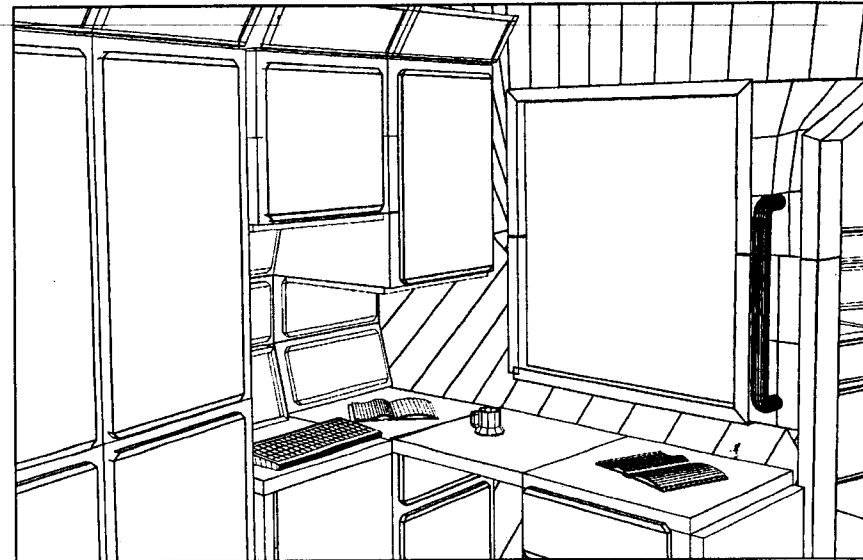

Figure 5.2.5.1.1-2. Perspective view into the microbiology laboratory.

5.2.5.1.1 Human Sciences Crescent

This crescent contains all the laboratories where experiments deal with human physiology. The two most critical laboratories are located next to the EVA chambers. Therefore, egress is simple if an emergency should occur (Figure 5.2.5.1.1-1).

The microbiology lab contains two workstations and one lab equipment repair workstation. The science and maintenance workstations are divided by a stowage locker that is made from the modular rack pieces. Likewise, the two microbiology workstations are separated with a full-sized stowage rack. Counter height lockers on casters with extra deployable work tops were added for maximum work surface and flexibility. Moveable furniture offers the ability for the crew to personalize the labs while they are at work (Figure 5.2.5.11-2).

Two workstations are located in the life sciences lab. Given the experiments that will be conducted in this laboratory, maximum floor space is required. Therefore, there are few pieces of furniture in this room. The furniture is moveable (Figure 5.2.5.1.1-3).

The medical facilities, by definition, need to be in a quiet yet highly

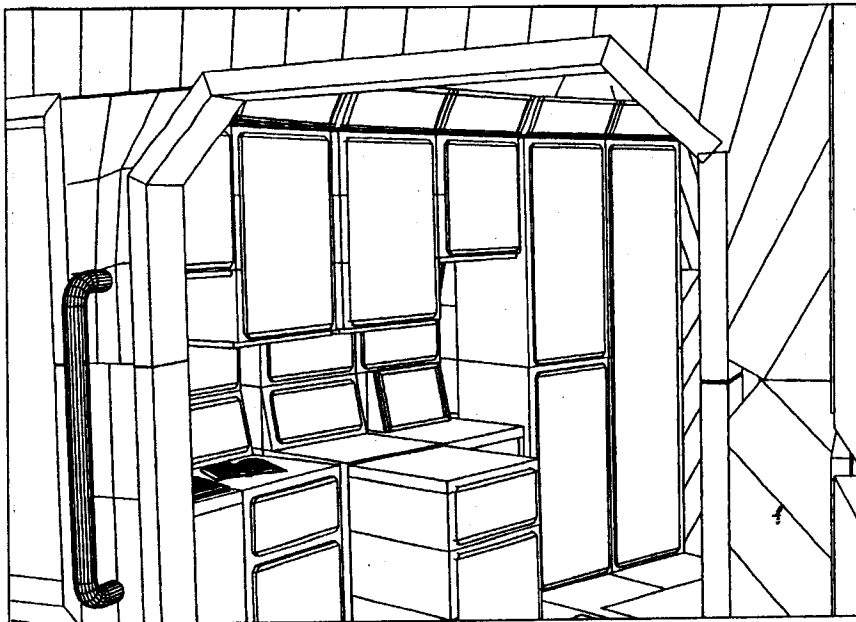

Figure 5.2.5.1.1-3. Perspective into the life sciences laboratory.

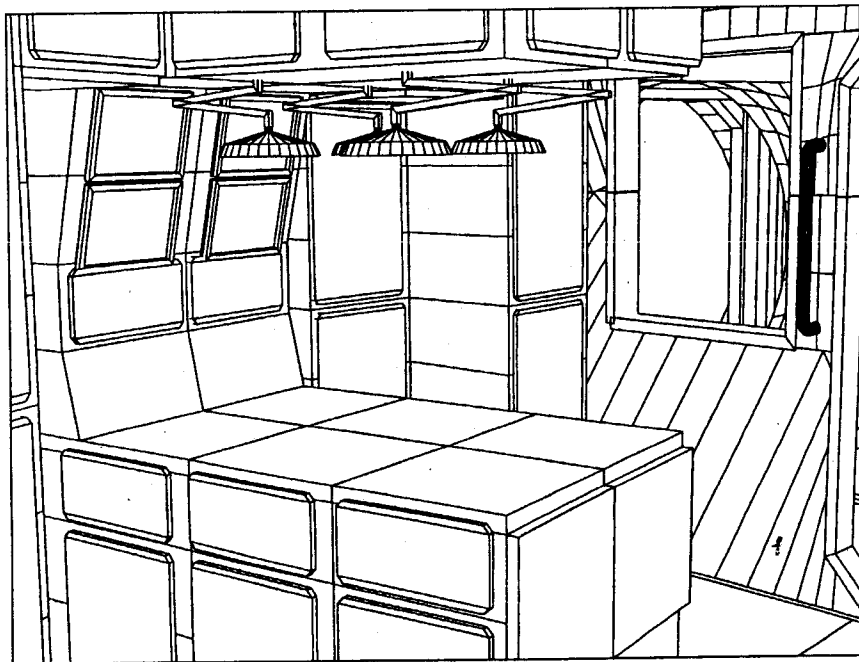

Figure 5.2.5.1.1-4. Health maintenance facility focusing on the examination table.

accessible zone. Thus, the life science lab and an EVA chamber act as a noise buffer. The near proximity to an EVA chamber offers ease of ingress and egress for incapacitated crewmembers and the use of the EVA chamber for hyperbaric procedures. One half hygiene is located here for the needs of any incapacitated crewmembers. It also serves this half of the torus. The examining table makes use of folding extensions to accommodate all sized crew (Figure 5.2.5.1.1-4).

5.2.5.1.2 Physical Sciences Crescent

This crescent contains all the labs where experiments deal with the lunar and interior environment. Laboratories that will need access to the exterior are located adjacent to EVA chambers. Included in this area are the botany laboratory and plant growth chamber, and the geomorphology laboratories (Figure 5.2.5.1.2-1).

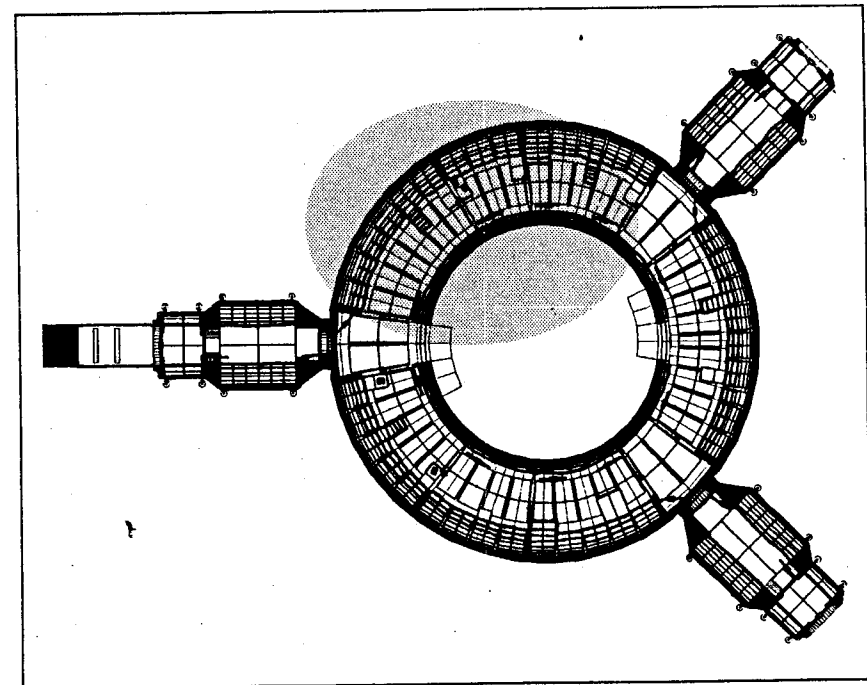

Figure 5.2.5.1.2-1. Physical sciences laboratories include the botany and plant growth chamber and the geomorphology laboratory.

The botany laboratory and plant growth chamber contains two workstations and enough space for the plant growth racks. The plant growth racks are located adjacent to the main EVA chamber to act as a symbolic front yard for the habitat. A window has been cut in the torus ceiling just above the plant growth racks that offers a view of nature from the library inside the dome.

Geomorphology deals with processing and analyzing elements from the lunar surface, thus it is located adjacent to an EVA chamber for ease of import and export. Likewise, the lab is divided into two sections to contain dirt and contamination. The "dirty" lab acts as the processing room and is directly adjacent to the EVA chamber. The "clean" room acts as the analysis lab and separates the plant lab from the "dirty" processing lab (Figure 5.2.5.1.2-3).

5.2.5.2 Mission Control

Mission control is three racks in width. One rack is dedicated to communications, the second is dedicated to computer functions, and the third to telerobotics.

5.2.5.2.1 Command and Communications Center

The command center will contain all the components to oversee the entire functioning capability of the base. Backup arrangements are designed into various locations of the habitat and remotely on the surface of the Moon (Figure 5.2.5.2.1-1).

5.2.5.2.2 Telerobotics Workstations

For remote functions on the lunar surface, robotic capability has been designed. A workstation has been dedicated to allow the crewmember the ability to not only control, but visually monitor the work of machinery or robots.

5.2.5.2.3 Suit Stowage and Maintenance

Nested within the mission control crescent are four racks that contain spare EVA suits. One work station is equipped for suit repair and maintenance (Figure 5.2.5.2.3-1).

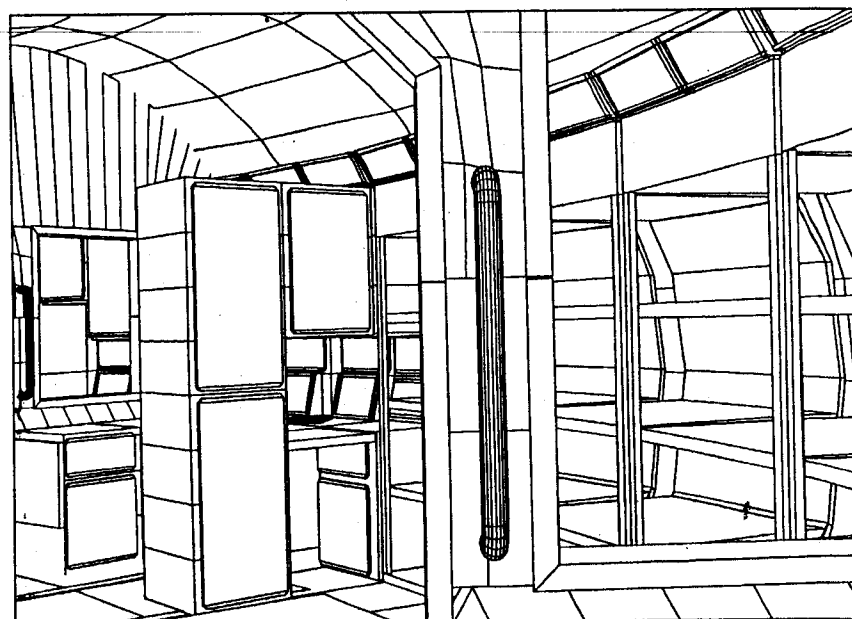

Figure 5.2.5.1.2-2. View into the botany lab, showing the plant growth facility racks and workstations.

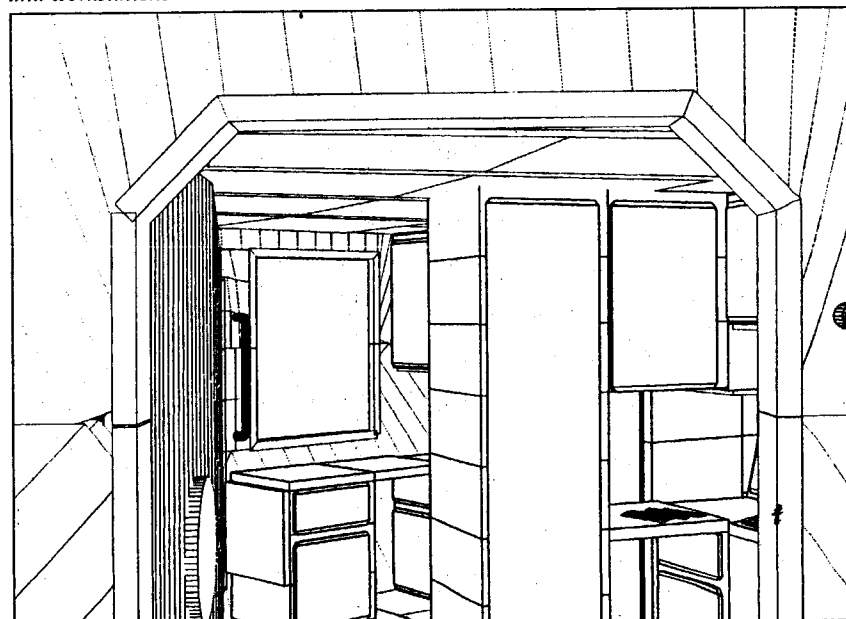

Figure 5.2.5.1.2-3. View into the clean and dirty processing room within the geomorphology laboratory.

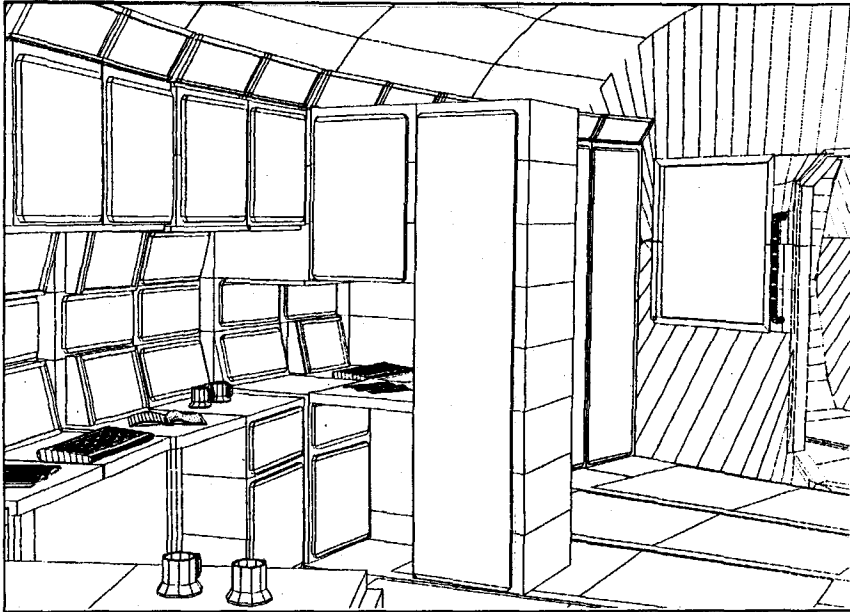

Figure 5.2.5.2.1-1. Command and communication center perspective.

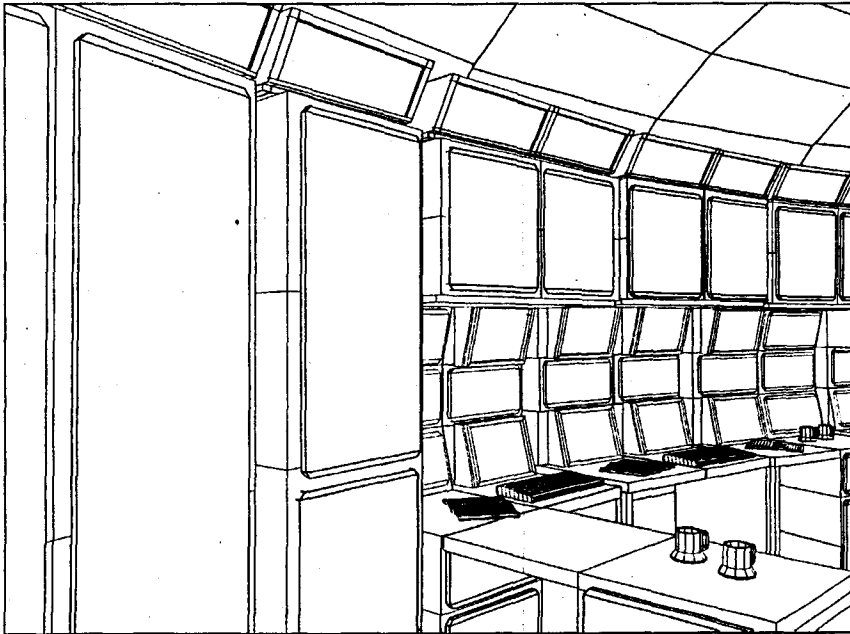

Figure 5.2.5.2.3-1. EMUs storage adjacent to egress points in the habitat.

5.2.6 DOMED INTERIOR OF THE ELLIPSOID

5.2.6.1 Crew Quarters

The crew quarters of Domus I are located on the lower level of the domed interior of the ellipsoid geometry. They are designed to accommodate a crew of 12, with four double and four single compartments. These are paired with two full hygiene facilities. Throughout the area, curved bulkheads have been introduced as a safety feature for locomotion. All the doors are retractable, requiring no additional volume for stowage or opening and closing. Crewmembers will have the option of personalizing their particular quarters with a number of interchangeable components and color choices.

The crew quarters can be isolated from the balance of the habitat at the bounding platforms. This is the designated safe haven for the crew. Caution and warning systems as well as mission control capability are integrated into the personal quarters location.

5.2.6.1.1 Entry Sequence

In the crew quarters on the lower floor, the design consists of a centrally located translation path that divides the floor symmetrically. Perpendicular to the central translation path are four equally spaced semi-private hall entries that lead to the crew compartments. This further divides the lower level into four quadrants, each accommodating three crewmembers, and a semi-private door to the hygiene facility. Each facility has two points of entry.

At either end of the central hall, bounding platforms are emplaced. The preference for this design option stems from the greater agility in upward movement allowed in 1/6th g. Adequate clearance above the head has been included to address this mobility. At approximately 1 m square in dimension, three platforms allow the crew to access the torus and the upper crew support level.

5.2.6.1.2 Single Compartment

Domus I contains four single crew compartments. Each is equipped with the following amenities: a horizontal bed, communications terminal with caution and warning systems, desk, chair, personal stowage compartments of modular design. Each room can be configured by the crew member to reflect personal preference. It is assumed that assignment to a single crew quarter will be a personal choice, yet have been discussed mutually amongst fellow crewmembers (Figure 5.2.6.1.2-1).

5.2.6.1.3 Double Compartment

Four symmetrical units have been designed to accommodate the double quarters. Again, personal choice will dictate those crewmembers that wish to occupy these quarters. The same features exist in the double as in the single quarters, with the exception that each feature is doubled in number (Figure 5.2.6.1.3-1).

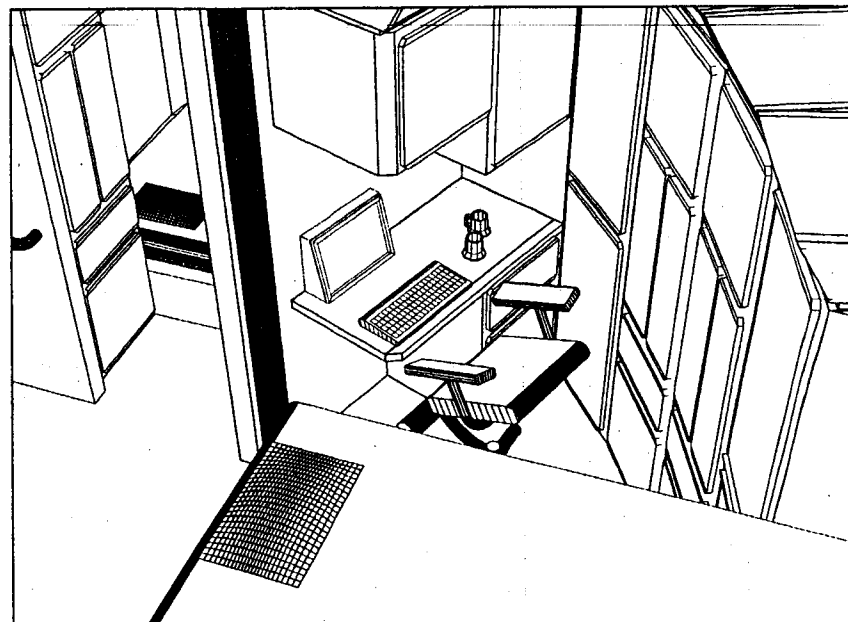

Figure 5.2.6.1.3-1. Perspective view into double crew quarter configuration.

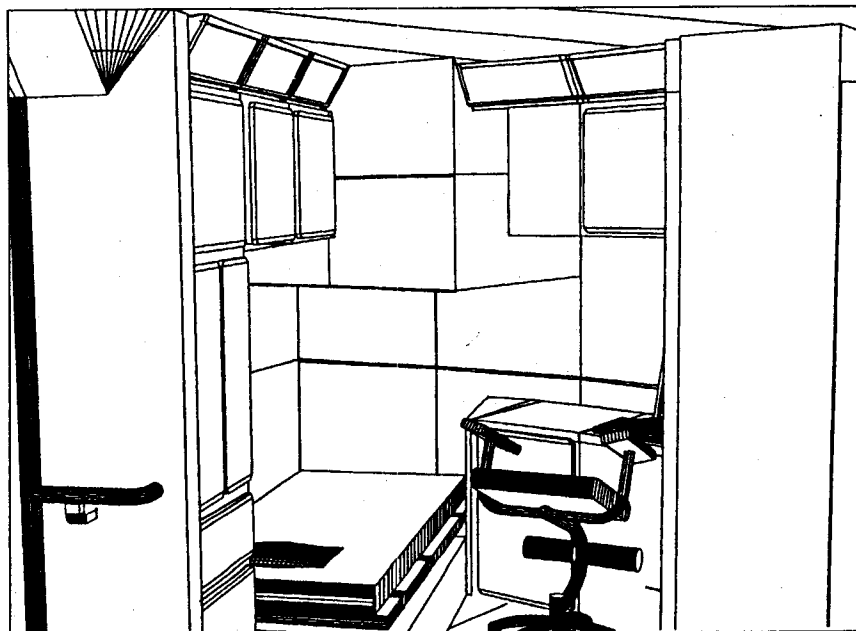

Figure 5.2.6.1.2-1. Perspective view into single crew quarter.

5.2.6.1.4 Hygiene Facilities

The hygiene facilities are divided into two location on the crew quarter level. This allows 6 crewmembers to utilize each facility. The facilities can accommodate 5 of the crew at one time, allowing for maximum use with minimum time necessary. The hygiene facilities consist of three toilets, three showers, and four eye, hand, and face washers. The units are self-contained in that each shower and toilet utilize pull-down doors, allowing for use of the remainder of the space. The spatial layout is of a central corridor design, allowing easy translation through the facility (Figure 5.2.6.1.4-1).

5.2.6.2 Crew Support Facility

The isolated and confined character of the lunar environment demands that there be a space dedicated to the crew's well-being and general care. By combining the eating, exercising, and recreation spaces, the crew will be encouraged to participate in all-group to small-group-dynamic functions. This has the ability to promote team cohesiveness in a lesser-stressed setting. The work and relaxation spaces have been clearly separated. By



Figure 5.2.6.1.4-1 (a and b). Hygiene facility provides hand/face/eye washing capability along with full body cleansing.

further separating group and individual functional areas, a variety of spatial experiences will be offered to the crew. Monotony and boredom is discouraged, and far reaching problems in crew performance may be lessened.

5.2.6.2.1 Bounding Platforms

As mentioned in the above section, the bounding platforms allow access to the various levels of the habitat. These have been designed to accommodate a fully-suited crewmember. Visual access is also permitted by the split level positions of the platforms. From the torus, a crewmember can see into the upper level. Translating down one step, visual access is gained to the central hallway of the quarters area. Lighting of the platform is provided, as are handhold to assist locomotion (Figures 5.2.6.2.1-1 & 5.2.6.2.1-2).

5.2.6.2.2 Wardroom

This volume within the habitat will serve as a central focal point for all the crew's leisure activities and celebrations as well as double function for group briefings and mission telecommunications. The dominant feature is the wardroom table. This table has the ability to be configured in a number of ways to allow for a flexible seating program. With panels stowed in the floor compartments directly below the table's perimeter, a crewmember will be able to easily access the panel and install it on the existing pedestal. The table can also be completely removed to allow the entire space to be open. The chairs that have been designed for the habitat are mobile and can be drawn up to the table to provide seating.

From this central point within the crew support area, the projection screens of the recreation area are visible. A crew member can prepare a meal in the galley and will use the table for eating. Small groups to the entire crew can be comfortably seated with generous surface space for working. A lighting system in the center of the table will provide task illumination for the crew. There will be a power supply and cable access to install a laptop computer. Circumscribing the wardroom space, an illumination light ring will provide general illumination. The key feature of this interior volume is the reconfigurability and allowance for crew involvement in its spatial arrangement (Figures 5.2.6.2.2-1 and 5.2.6.2.2-2).

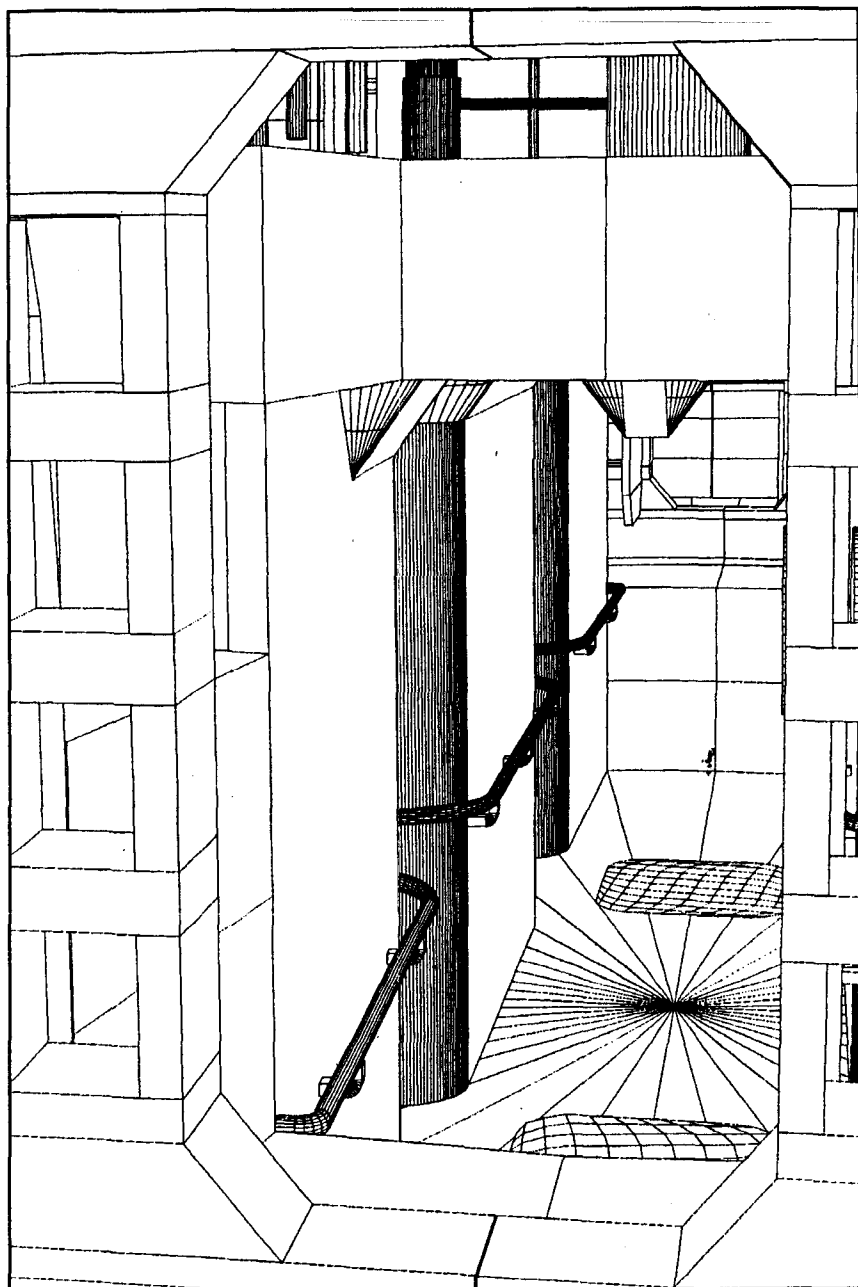

Figure 5.2.6.2.1-1. Bounding platforms allow crewmembers to translate between levels of the habitat in two, three or four steps.

5.2.6.2.3 Library

Providing a variety of spatial experiences was a key directive in the design of *Domus I*. Given that technology has allowed great amounts of information to be stored electronically, a quiet location has been provided to access personal choices of reading material, and the choices can be electronic as well as hard copy. The library is adjacent to the galley, yet divided by a rack component system. The torus has had a window emplaced and provides a viewport into the plant growth laboratory. Comfortable seating is provided as well. Desk space also includes computer capability. Stowage for hard copy information is designed. (figure 5.2.6.2.3-1 and 5.2.6.2.3-2)

5.2.6.2.3 Galley

Meal preparation and consumption will be an important activity for the crew. The galley is designed for efficiency in preparation, ample stowage for consumables and implements for cooking. Depending upon the methods being currently developed, foods will be stored in ready-to-eat form, dehydrated, thermostabilized or freeze-dried. These methods will dictate the type of appliance necessary to prepare the food for eating. Storing additional food will be accomplished by using refrigeration/freezer units. Additional appliances designed into the rack system are the sink, dishwasher, and microwave/convection oven.

Cleanup will be easily accomplished. Counter space has been designed for working surfaces. Lighting is built into the wall rack system adjacent to the library space. Surface colors and textures as well as the illumination type will be of the kind to compliment the color of food. (figure 5.2.6.2.3-1)

5.2.6.2.4 Recreation

The crew will require an area that will permit them to have visual and audio programming to enjoy. The recreation area has been designed with a large projection screen system as the focal point. There is a rack component system that spatially divides the recreation area from exercise. Yet this entire space is clearly visible from most points within the upper floor of the habitat. The design was driven by the proximities of the galley, the wardroom and the desire to allow the crew to enjoy perhaps a video or a viewing of the surface of the Moon during their relaxation time after their

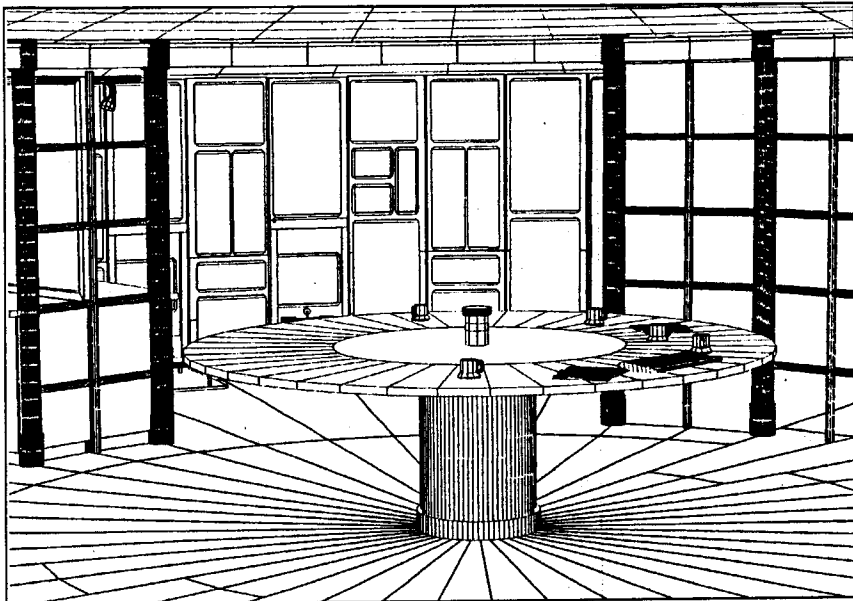

Figure 5.2.6.2.2-1. Wardroom contains a table capable of seating two to twelve crewmembers. When not needed for large groups, the table components fit into compartments in the floor directly beneath the table.

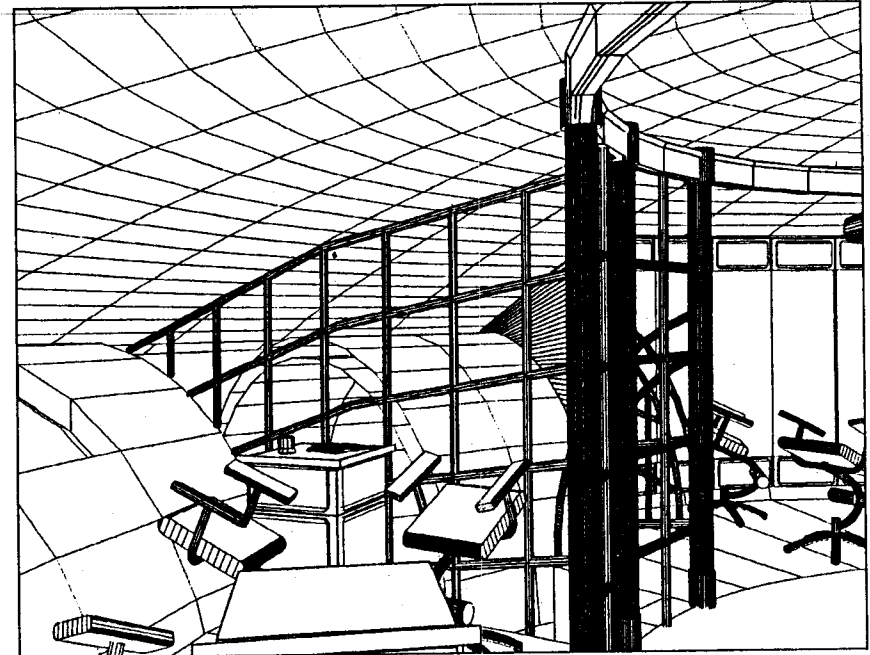

Figure 5.2.6.2.3-1. Library is designed for quiet and small group activity.

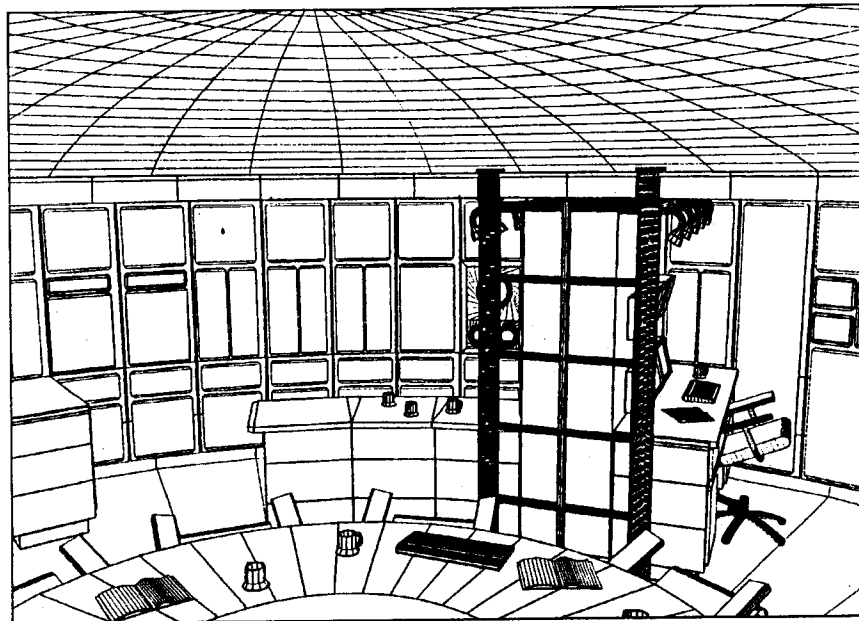

Figure 5.2.6.2.2-2. View from wardroom into galley and library.

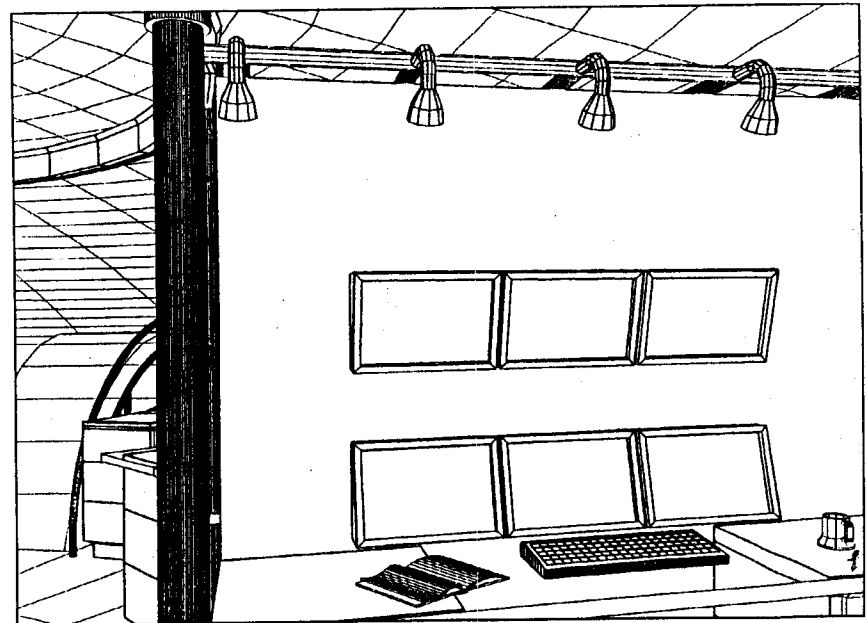

Figure 5.2.6.2.3-2. View of library workstation.

duty shifts, while eating or preparing their meals. A major benefit of the large screen system is the ability to conduct full-crew briefings with all seated at the wardroom table. The screen system was positioned to allow unobstructed vantage points for those seated. The projection system is located above the table, attached to the light ring.

Stowage components have been included to allow room for tapes and any additional equipment deemed necessary for listening to music or watch the monitor. The floor space was purposely left open to allow the crew the option to bring a chair into the space or to simply lounge on the floor (Figure 5.2.6.2.4 -1).

5.2.6.2.5 Exercise Facility

The serious physical deterioration on the human in lesser gravity demands the crew exercise often. As stated earlier in this text, the crew must be encouraged to perform the exercises. By providing an environment that is conducive to exercise, and enjoyable to be in, the crew will be more

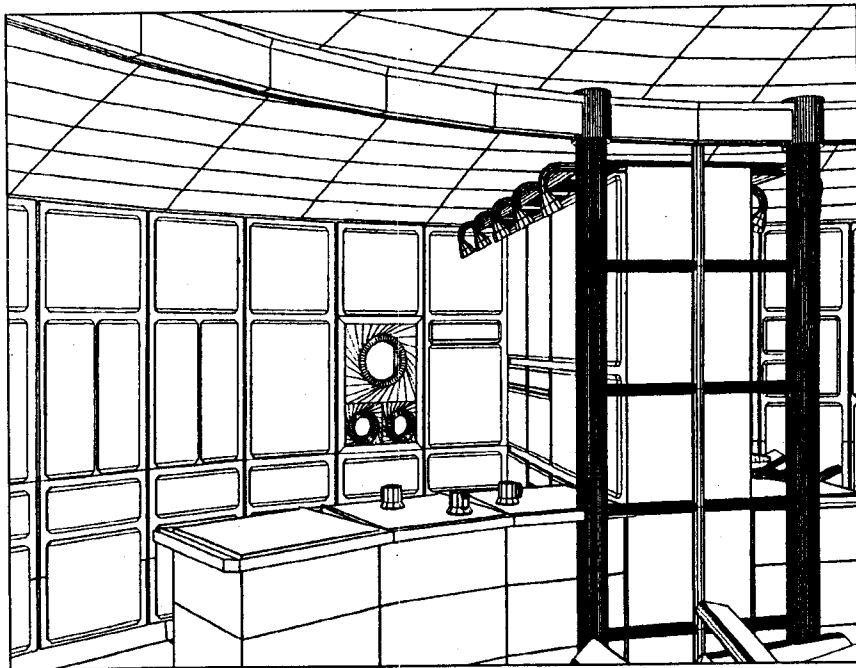

Figure 5.2.6.2.4-1. Galley in the crew support facility, as viewed from wardroom.

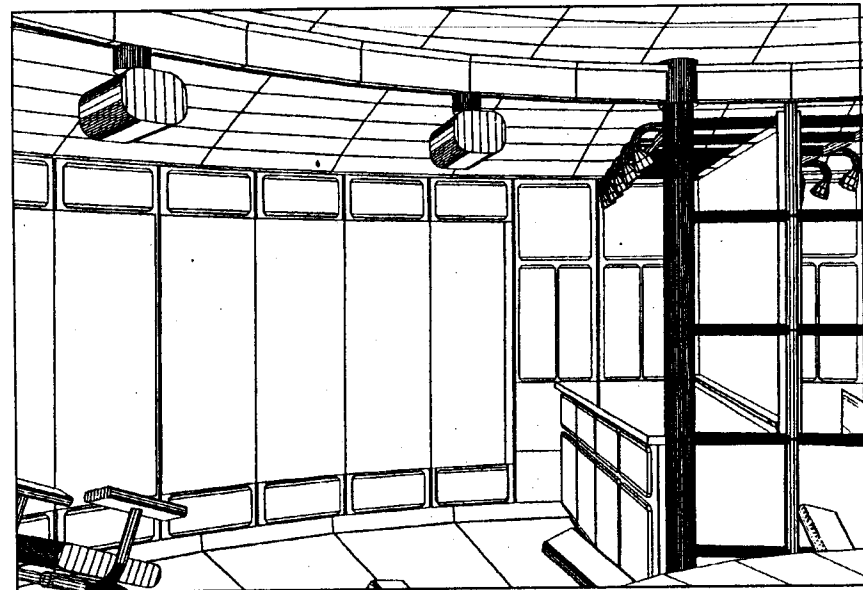

Figure 5.2.6.2.5-1. Perspective of the projection screen system in the recreation area of crew support.

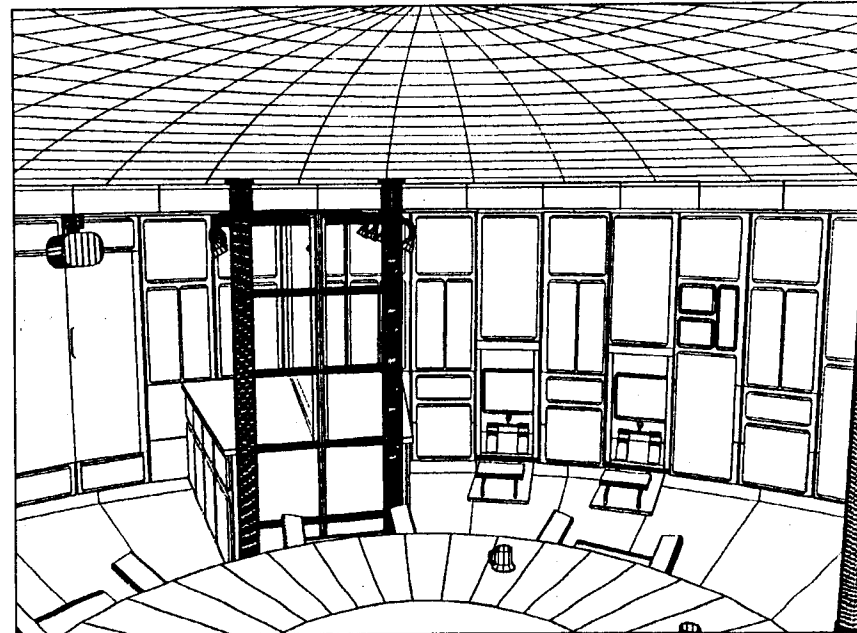

Figure 5.2.6.2.6-1. Exercise countermeasures are necessary for crew health. The two machines stow in the upright position to allow for additional floor area.

willing to participate. Exercise countermeasure equipment that dual functions has been included in this area. Visually, the crewmember will focus on the wall ahead of the machines. In this space, projection monitors have been installed to provide a variety of settings in which to exercise. Suggestions are unlimited as to what scenery could be shown, be it Earth-related or created fantasy. The equipment itself is capable of being stowed in the upright position, compacted into the wall rack system. This removes the equipment should the additional space be required for a crew function (Figure 5.2.6.2.5-1).

5.2.6.2.6 Limited Hygiene Facility

Although full hygiene facilities are located just below the crew support level, a limited facility was designed adjacent to the exercise area. This provides quick access immediately following exercise without necessitating the crewmember traverse the platforms and travel to the facilities below. The distance to the lower level hygiene is not great, but this amenity is modest and provides a great convenience for the crew (Figure 5.2.6.2.6-1).



Figure 5.2.6.2.7-1. A limited hygiene facility services the exercise area and alleviates the need for the crew to translate to the lower level.

6.0 DYMATION PROPOSED LUNAR HABITAT AND RESEARCH FACILITY

6.1 MASTER PLAN

The 'dymaxion' lunar base scheme borrows from Buckminster Fuller's term meaning to seek the most advantage with minimal input. Design for an extreme condition such as the Moon (and Mars) certainly demands such efficiency. An effort is made in this concept design to explore advantages and trade-offs utilizing this design principle in the context of a lunar base.

The base consists of two zones a work zone and a habitation zone (Figure 6.1-1 and 6.1-2).

The work zone consists of :

- 3 SSF tubes (4.5 m in diameter x 14.5 m in length) for research functions
- mission control hub (4.5 m in diameter).

The habitation zone consists of :

- 3/4 inflated sphere, 5 m in radius: habitation inflatable
- central mast (multi-purpose: structural load bearing, circulation, HVAC)
- external viewing cupola

6.2 CONSTRUCTION SEQUENCE

6.2.1 TELEROBOTIC PRE-FLO

The delivery of the base is completed in 3 loads of one SSF tube each, (with complements) (Figure 6.2.1-1).

The first carries the mast within its interior circulation space. The mission control hub remains integrated with the mast through-out delivery and deployment. After landing, the mast and hub unit is telerobotically disconnected from the research tube and uprighted, mission control hub down, and locked to the end the SSF research tube. A high performance

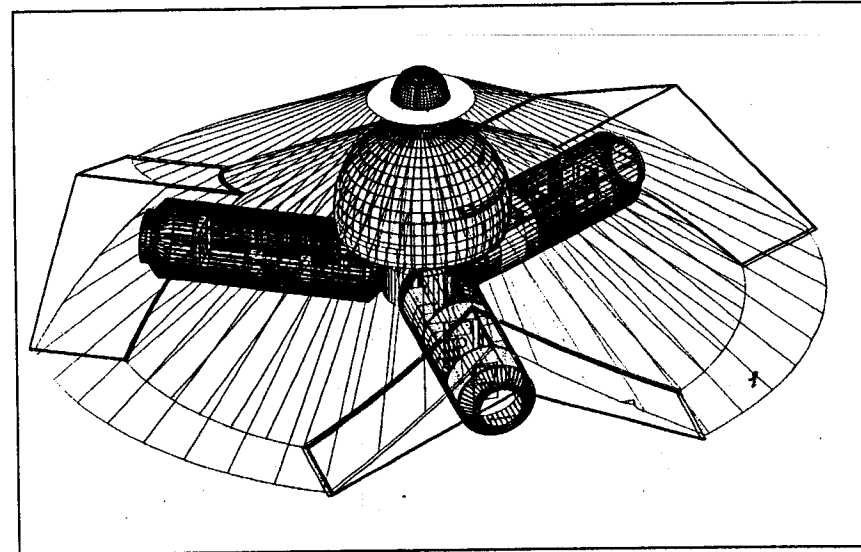

Figure 6.1-1. Exterior isometric illustrating the base components: tubes, dome, cupola, and shielding system.

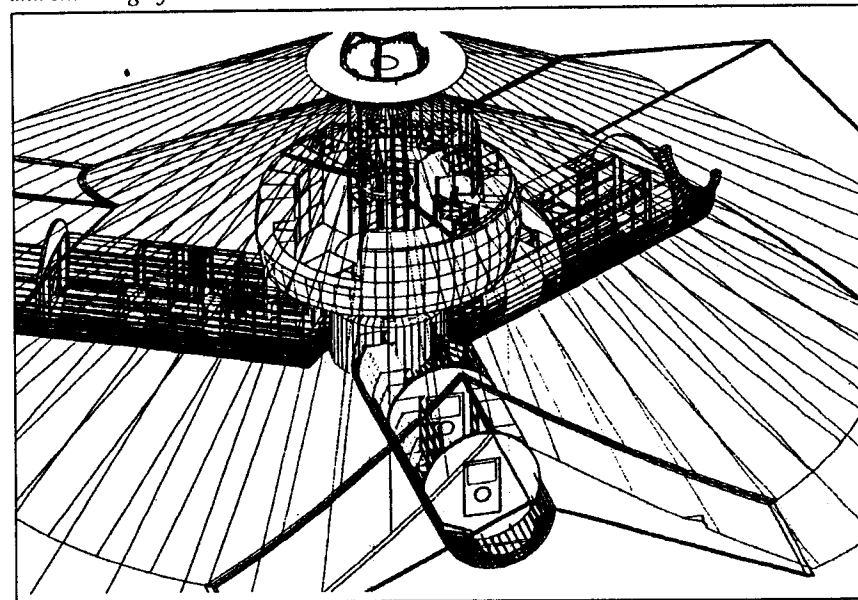

Figure 6.1-2. Section isometric illustrating levels of work and relaxation.

Kevlar composite canopy is deployed from the head of the mast and anchored into the lunar substrate — forming a conical geometry.

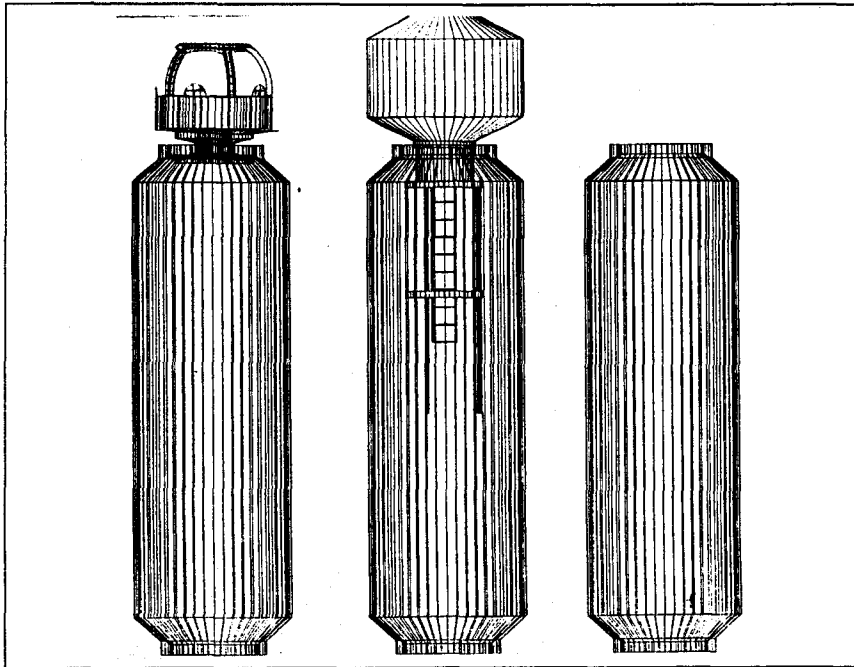

Figure 6.2.1-1. Packaged components of the lunar base. Tube dimensions are 14.5 m in length, 4.5 m in diameter (SS-Freedom-derived).

6.2.2 TELEROBOTIC SHIELDING PHASE

Shielding for the habitat/research center is achieved by loading the tensily stressed canopy with a 2.5 m blanket of regolith. The regolith is collected via telerobotic controlled rover/machinery, screened, and then advanced via belt driven shovels up the vertical center of the mast. Through an opening at the apex, regolith is unloaded unto the exterior of the canopy. The "fabric" (specifically Kevlar) is abrasion resistant, tensily strong, and light-weight. The angle of repose of the regolith (30-35 degrees) mandates the slope of the canopy (Figures 6.2.2-1, and 6.2.2-2).

The canopy is anchored to the lunar surface with screw-type (auger) anchors, which reach below the powdery regolith to the rocky substrate, 2.5 cm to 7.5 cm below the surface. Two to three meters of regolith evenly distributed on the canopy provide adequate shielding from the wide range of radiation and micro-meteorites visited upon the site (Figures 6.2.2-3 and 6.2.2-4).

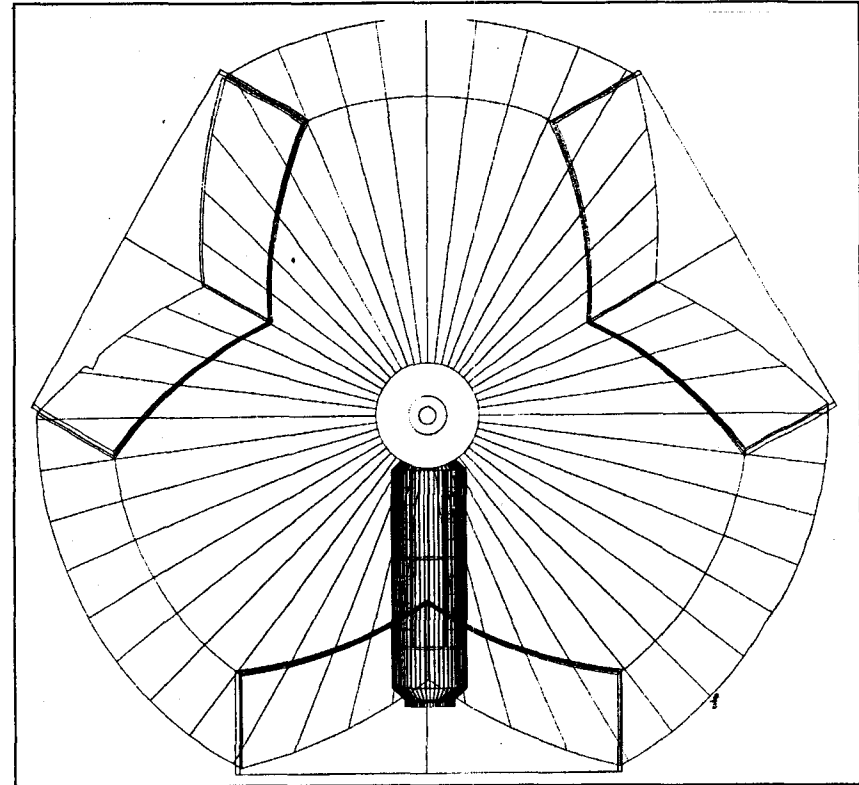

Figure 6.2.2-1. Plan of telerobotic shielding phase. Canopy has been deployed, mast head and regolith layer has been added.

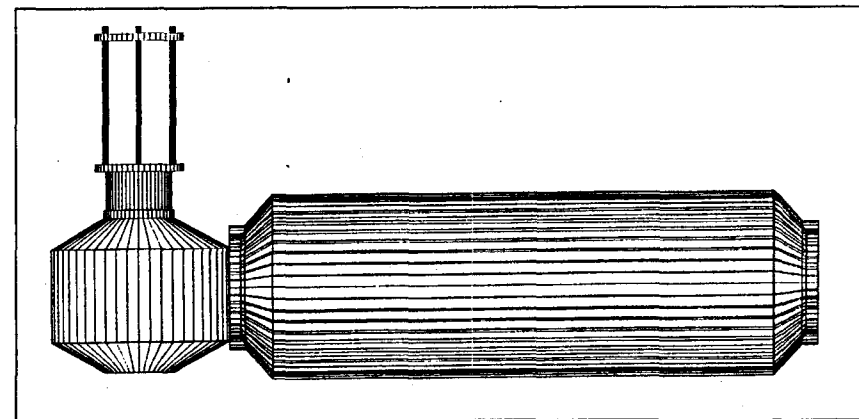

Figure 6.2.2-2. Elevation of first SSF-derived tube with mast uprighted.

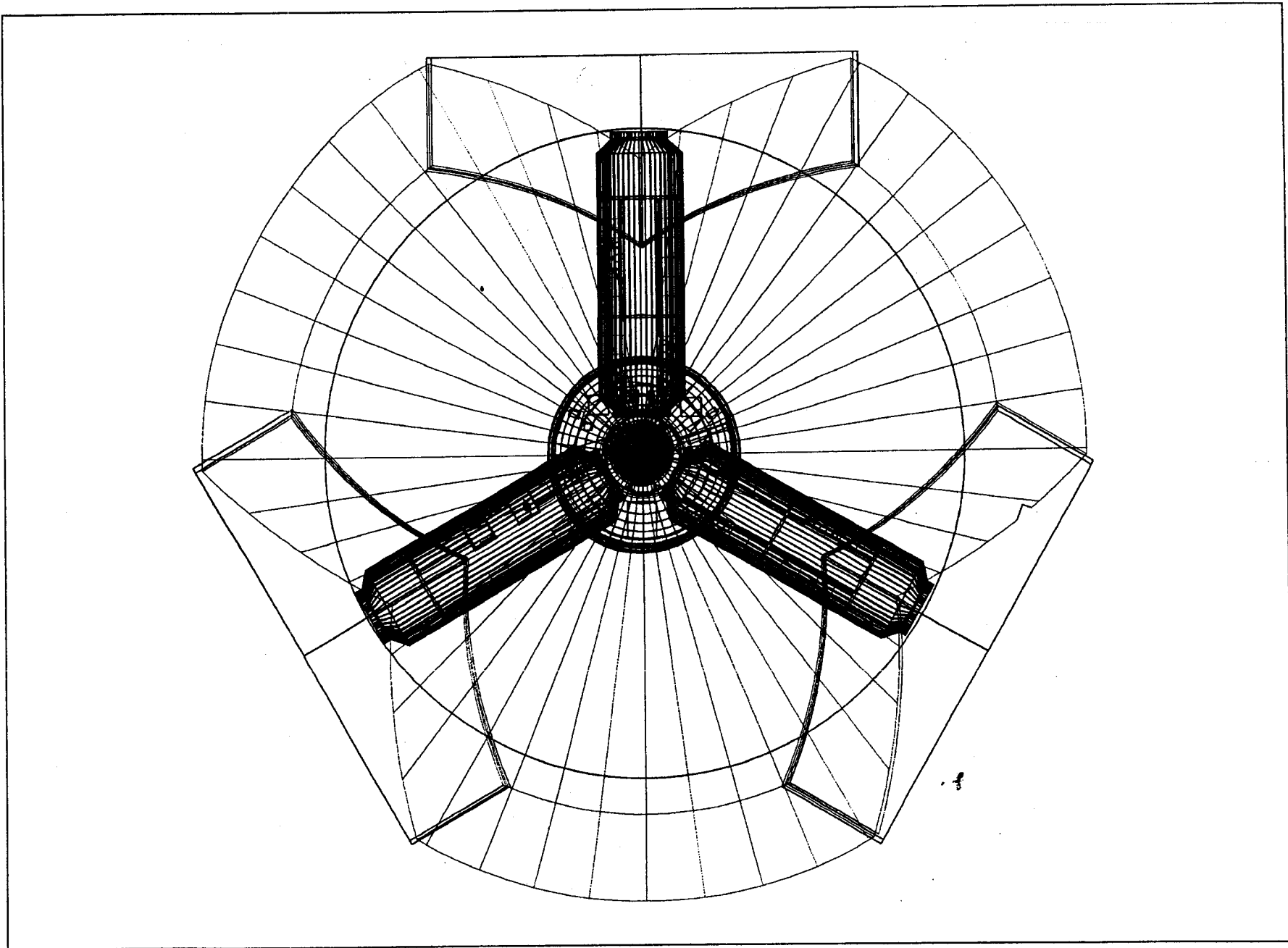

Figure 6.2.2-3. Plan view of completed base.

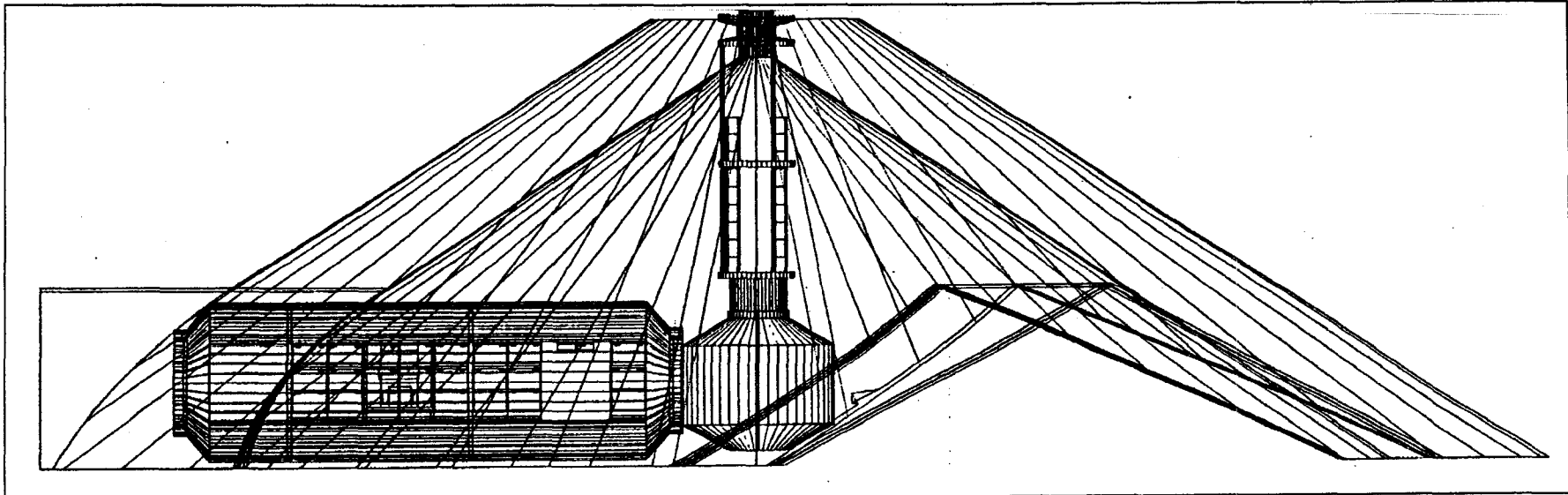

Figure 6.2.2-4. Elevation of telerobotic shielding phase.

6.2.3 CONTINUED CREWED CONSTRUCTION

The construction sequence continues after the shielding phase is complete. Two crewed SSF research modules are integrated with the mission control hub through hanger openings in the shield. Meanwhile, the habitation level inflatable has been deployed from the mast and is undergoing outfitting. The central mast provides a 'package' for the primary element of the habitat level. Composed of 3 graphite fiber epoxy tubes, the mast carries the load of the regolith shielding, provides a vertical circulation corridor, and provides a backbone for the HVAC components, electricity, water, communications, and environmental controls.

The base is complete when all 3 research modules are integrated with the mission control hub, the habitation level is outfitted with crew quarter and supports facilities, and all 12 crewmembers are on site. The telerobotic shielding phase provides a "hardened" shelter for the safe reception of the crew.

6.3 INTERIOR COMPONENTS AND DIMENSIONS

6.3.1 RESEARCH LABORATORIES

The three research lab modules form arms off the central mission control hub at 120 degrees equally (Figures 6.3.1-1 and 6.3.1-2). Located at the end of each arm, opposite the hub, is an air lock which acts as an emergency safety zone. Each air lock houses communications, emergency supplies, and 6 suits. Should an emergency situation cause for the closure of any one arm, the remaining two arms continue to provide for the 12 crew members. In addition, the three modules can be closed off between labs.

Flexible connectors between the modules and the central hub circumvent the transfer of vibrational energy. Likewise, the connector between the hub and the habitation inflatable above are also flexible.

The major circulation route in/out the base is through the high use/high circulation /contact module: the exercise/personal hygiene laundry mod (Figure 6.3.1-3).

A dust-off enclosure is placed at its entry. Focusing the dust-off at this point eliminates the redundancy of dust-offs at all arms ends. Exits would still occur at the other ends, however if all entries are handled at one dust-

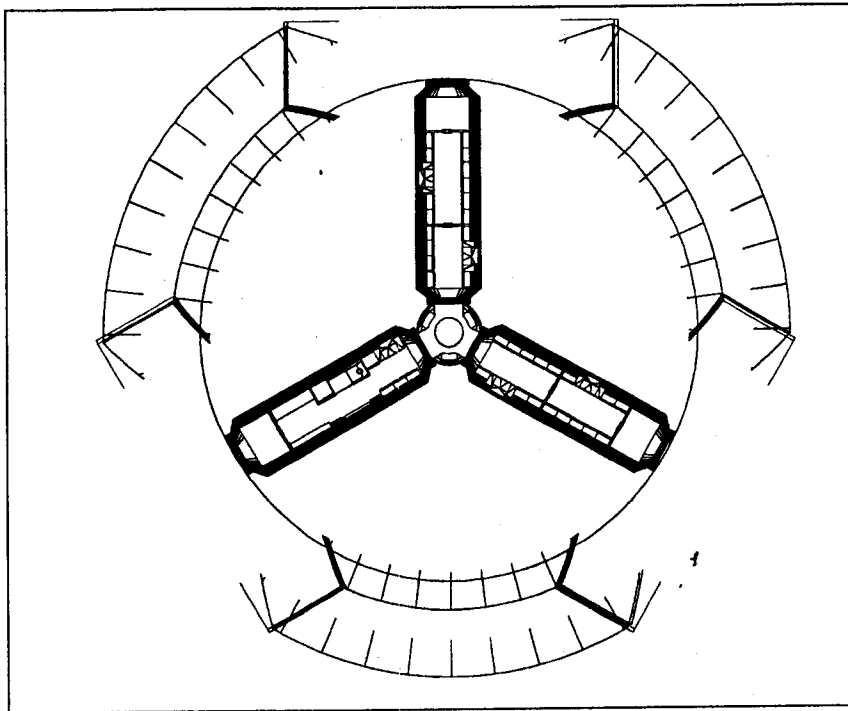

Figure 6.3.1-1. Section plan of first level work zone.

off installation, energy and material are conserved (Figure 6.3.1-4).

6.3.2 MISSION CONTROL

The mission control hub, 4.5 m in diameter, is delivered on it's side attached to the end of the first research module. The hub is the pivotal gateway between the lower work environment of the research modules and mission control functions and the upper habitation inflatable. Centrally located, the hub coalesces the activity of the base as well as providing a center of communications and a telerobotic workstation. Entrance to the upper habitation level is assisted by a pull-down ladder.

6.3.3 HABITATION INFLATABLE

The habitation inflatable is a deck and a half. The central mast provides vertical circulation. Horizontal circulation radiates outward at each level. The habitation inflatable houses crew quarters and crew-support facilities (Figure 6.3.3-1. and 6.3.3-2).

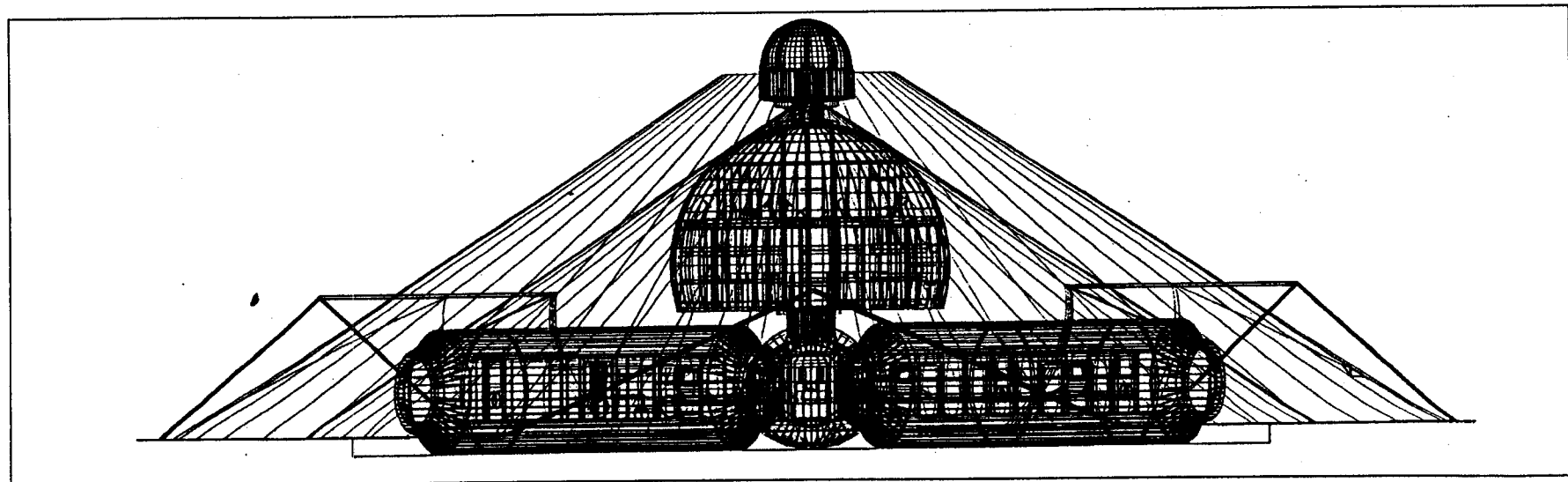

Figure 6.3.1-2. Elevation of completed base.

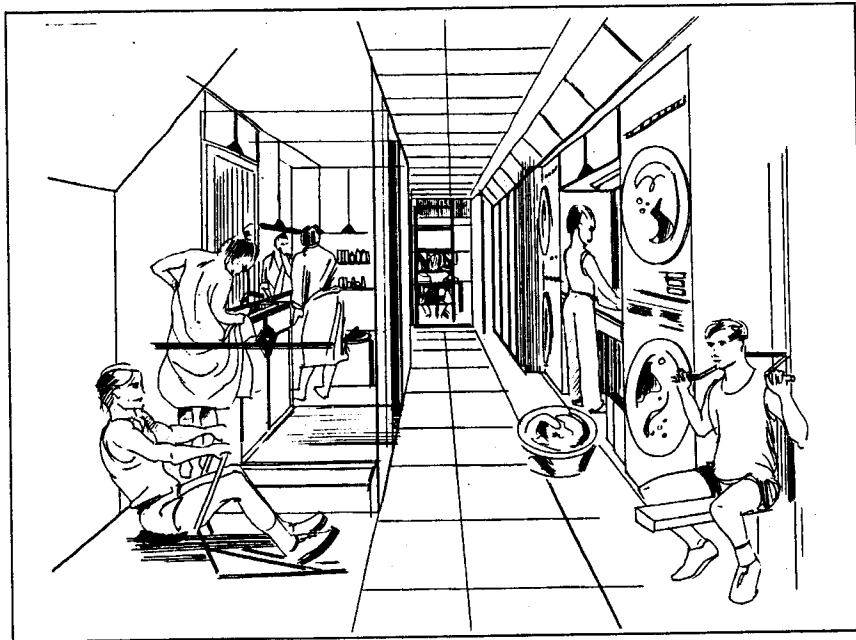

Figure 6.3.1-3. Interior perspective of research module containing plant growth lab.

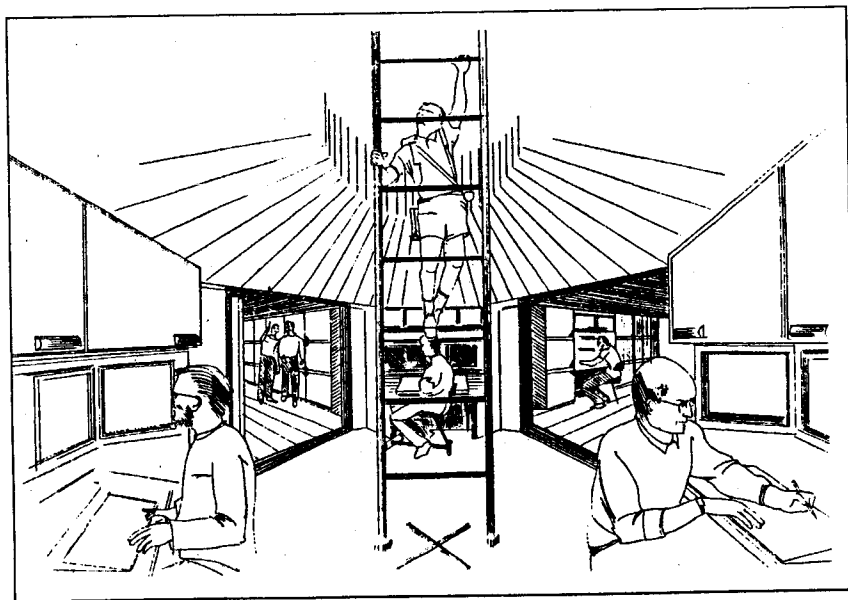

Figure 6.3.1-4. Mission control hub.

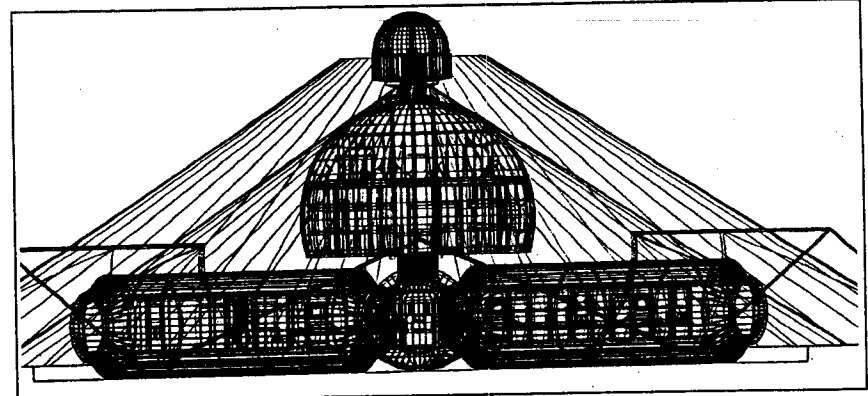

Figure 6.3.3-1. Section of base components with upper level housing the habitation area. Translation to the habitation level is gained through the mast vertical circulation.

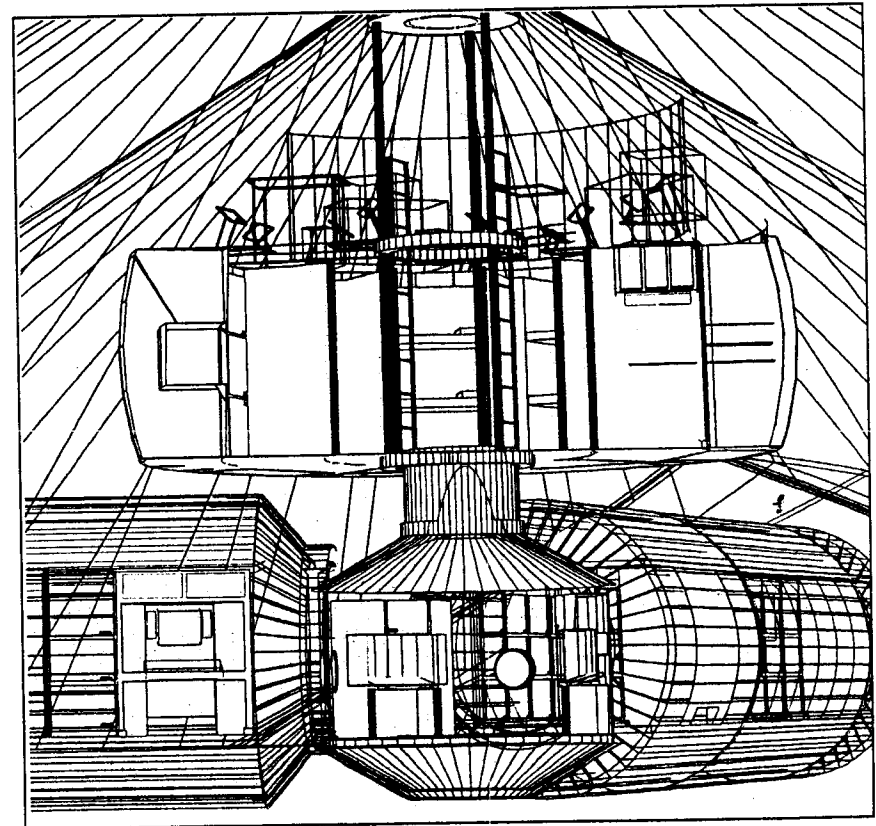

Figure 6.3.3-2. Section of mission control hub and habitation inflatable.

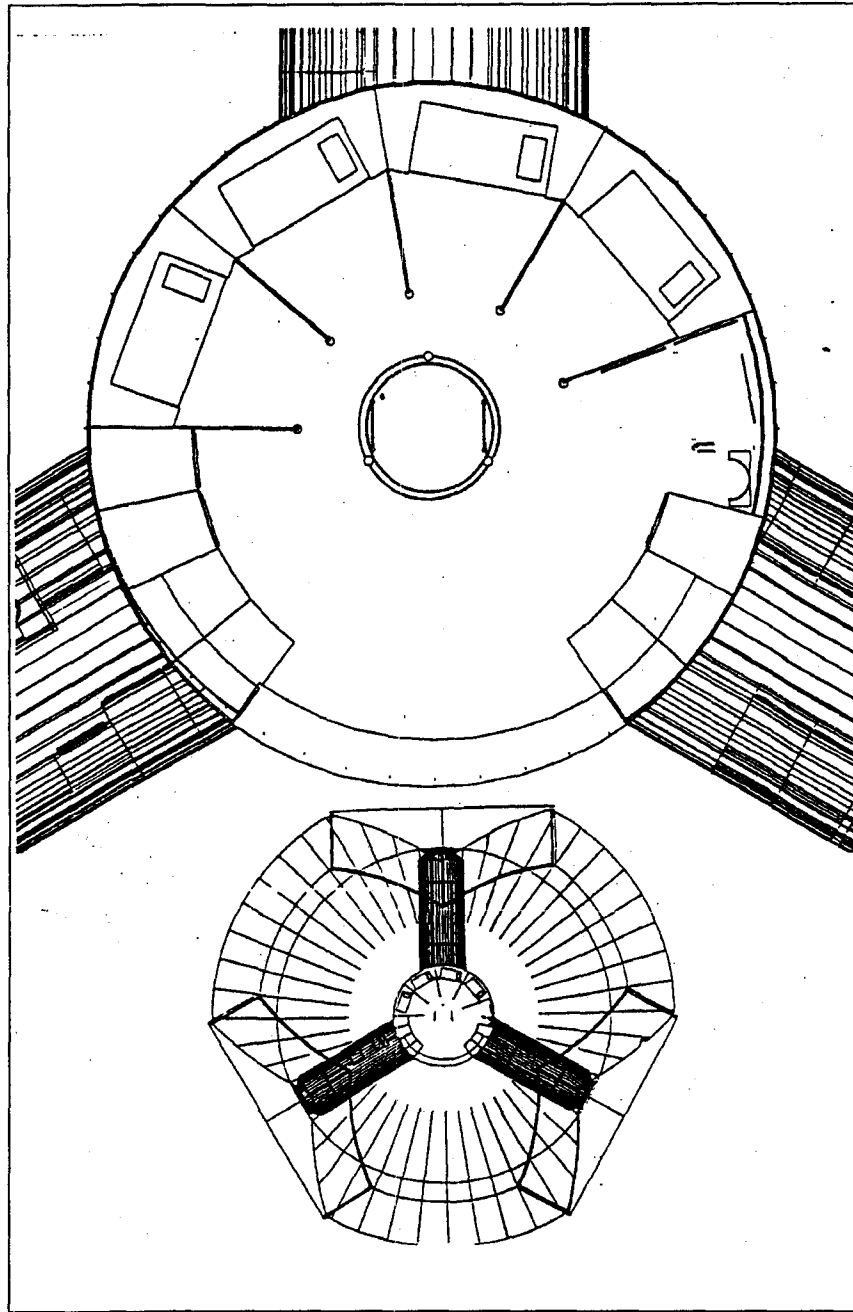

Figure 6.3.3.1-1. Plan of habitation level showing crew quarters and crew support.

6.3.3.1 Crew Quarters

Crew quarters are located beneath the upper deck and shielded acoustically on each end with food storage and personal hygiene. Four rooms provide a triple bunk each for a total of 12 beds. On a split shift, 6 on 6 off, the uninhabited bunk space in each room would be shared by that room's occupant(s).

Personal storage is housed within each bunk compartment. Clothes hooks line one common wall to the entry, with a closet on the opposing wall (Figure 6.3.3.1-1).

6.3.3.2 Crew Support

The main floor also houses the large common area-(food preparation, galley, recreation, meeting area). Storage racks, delivered with the SSF modules and circulation (dead space), are brought up through the mast and situated along the interior of the inflatable. The racks provide storage while also protecting the inflatable from trauma. A multi-purpose fold away table located midway in the public-active semi-circle provides for eating, meetings, recreation. A projection screen on the interior of the inflatable's skin above the table provides a concave screen for a variety of applications. Exterior viewing via fiber optics, earth communications, and recreation viewing (such as movies, education) are possible (Figures 6.3.3.2-1 and 6.3.3.2-2).

The upper half deck is a passive recreation area for reading, quiet socializing, meditating, music enjoyment as well as a place for expanded plant growth. The open plan allows for creative reconfiguration. The balcony overlook offers a vantage point over the activity below. A storage zone rings the perimeter of the deck, enclosed by a suspended curtain.

The mast is capped off with a 3 m-diameter exterior viewing cupola, accessible through a hatchway at the top of vertical circulation corridor. The cupola also provides protection for sensitive research instruments (Figure 6.3.3.2-3).

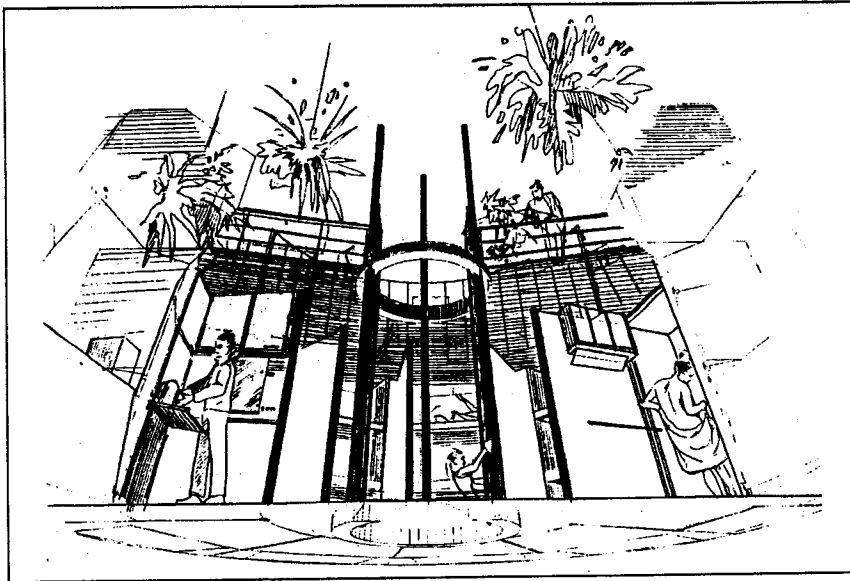

Figure 6.3.3.2-1. Interior perspective of habitation inflatable looking towards the crew quarters and upper recreation loft.

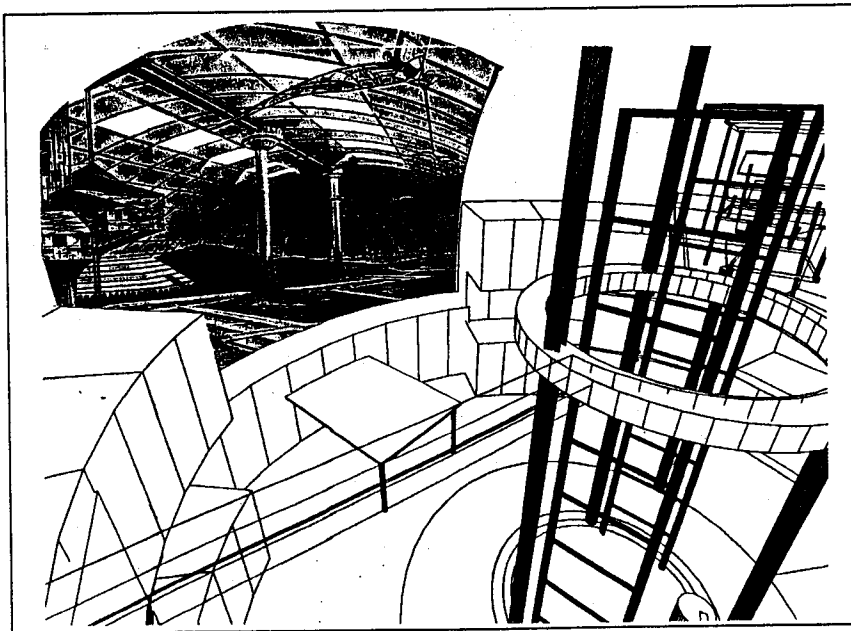

Figure 6.3.3.2-2. Interior perspective of habitation inflatable looking down from the balcony into the multi-purpose galley/food preparation/recreation space.

6.4 CRITICAL DESIGN FEATURES OF DYMATION

6.4.1 SHIELDING

Regolith shielding will perform the important task of protecting the crewmembers, equipment and logistics. Key features of the *Dymation* concept include:

- telerobotic shielding phase
- canopy utilizes regolith angle of repose
- minimal structure required for shielding — thin canopy and anchors, mast double functions
- one point regolith dispersal
- ease of inspection - research modules and inflatable exterior
- open-plan under canopy (aside from central mast), allows for reconfiguration of components, as well as providing additional storage (unpressurized)

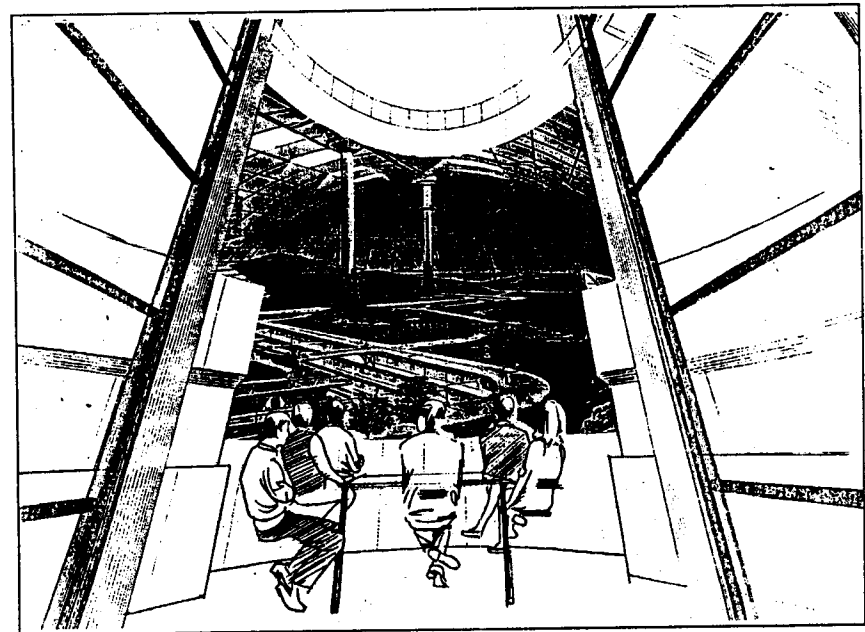

Figure 6.3.3.2-3. Interior perspective of inglatable illustrating projection screen on the interior surface of the inflatable.

- 2.5m thickness of regolith blanket (provides adequate protection from micro meteorites and radiation)

6.4.2 PACKAGING

- base requires 3 payloads
- mast and inflatable delivered within first module's circulation space
- mission control hub delivered attached to mast, delivered with first load
- known SSF (space station freedom) module technology
- minimal additional packaging
- components can be dis-integrated from the base and set up elsewhere

6.4.3. ZONING

Separation between:

- work environment (lower) and habitation (upper)
- crew quarters (private) and crew supports (public)

In addition:

- hatches within research modules separate labs
- flexible connectors between research modules and mission control hub, and hub to habitation level. Dampens the transferal of vibrational energy.
- safety (zones) located at each end of research module arm (airlocks)

6.4.4. MULTI-FUNCTIONING

- central mast performs as structural pillar, circulation corridor, HVAC frame
- interior of inflatable serves as viewing screen (habitation level)
- multipurpose area of (galley, wardroom, recreation)
- modularity of racks, components

6.4.5. VARIETY OF SPACES

- double height space of habitation inflatable
- upper "loft" and viewing balcony (quiet recreation area)
- research lab situations
- crew quarters/support situations
- exterior viewing cupola

6.4.6. INTERIOR SPACES

- minimizes circulation; the research labs are in the 2 m- width corridor which double functions as a work area; inflatable : circulation radiates off central mast corridor
- research modules and mission control hub (linkage): ease of visual and verbal communication and reference (line of sight)
- crew quarters: expandable bunk situation (split shift)

6.4.7. ADDITIONAL

- flexible to a range of site conditions (doesn't require extensive site preparation)
- main entry through one module: focuses dust-off and traffic (corridor)
- reconfiguration possibilities: post-occupancy scenarios/ industrial applications
- advantages of the inflatable: packaging, volume to weight yield, conforms to pressurized environment, ease of set-up, deployment time

6.5 QUANTITATIVE VOLUMETRIC DIMENSIONS OF DYMATION

6.5.1 LABORATORIES

plant	20 m ²
geomorphology	20 m ²
life science	20 m ²
micro- biology	20 m ²

6.5.2 MISSION CONTROL

telerobotic workstation	2 m ²
mission control	4 m ²

6.5.3 CREW QUARTERS

personal quarters	25.5 m ²
hygiene(lower)	4 .0 m
(upper)	5.5 m ²

6.5.4 CREW SUPPORT

galley	13 m ²
food storage	10 m ²
health maintenance	12 m ²
laundry	4 m ²
exterior viewing	6 m ²

6.5.5 SERVICE

safehaven (air locks)	36 m ²
storage (upper loft)	15 m ²
NET	255 m ²
x multiplier (25%)	<u>63.75 m²</u>
GROSS	318.75 m ²

Quantitative General Dimensioning

Canopy

interior volume	4069.44 m ³
radius	18 meters
height	12 meters
slope	33 degrees
surface area	565.25 m ²

Regolith

volume	4787.69 meters ³ (depth of 2.5 meters)
--------	---

Sphere (3/4)

radius	5 meters
volume	392.5 meters ³
surface area	147.2 meters ³

Gross Volumes

inflatable	392.5 meters ³
hub	47.5 meters ³
h mods	596.4 meters ³
Total	1036.6 meters ³

Gross volume of cone 4069.44 meters³

Gross volume of regolith 4787.69 meters³

7.0 SUMMARY AND CONCLUSIONS

7.1 CRITICAL DESIGN FEATURES OF *DOMUS I*

Domus I is the result of a feasibility study of the Chow and Lin PSSMS concept on the lunar surface. *Domus I* allows separate work and relaxation realms within the habitat. Different functional spaces are able to be designed differently. The torus portion, dedicated to the laboratories, differs in geometry, color scheme, and workstation arrangement from other parts of the habitat. Work spaces are open; walls have windows emplaced to promote a visual sense of spaciousness.

Those areas dedicated to the crew are in the central domed ellipsoid. Some spaces, like crew quarters, have curved outer walls. Translation spaces in the crew quarters are rectilinear, centrally located, and clearly connected to the bounding platforms. The crew has a choice of single or double quarters, personalization is encouraged with interchangeable panels of differing colors, and privacy when needed is assured. The crew support facility is somewhat removed from the private crew quarters. It is designed as an open-plan arrangement with a larger central volume to serve the entire crew and supporting facilities on the perimeter. This area allows interaction among the crewmembers, both visually and socially.

Safety is a prime requirement of any structure housing human life. All levels and spaces in the habitat have been designed with dual means of egress, and the ability to "lock down" a specific area in the event of a system failure or to secure the crew in the event of a solar flare. Communication and computer systems can be accessed in numerous locations throughout the habitat. Provisions for short-term stays in the safe haven area—the crew quarters—have been included.

The rack component system allows for change-out and can be shifted within several areas. These designs respond to the change in the anthropometric alignment of the body in the 1/6th g of the Moon.

As yet, widespread testing of inflatable technology—and of the PSSMS system in particular—has not been accomplished. The theory behind inflatables, e.g., great volume attained with a reduced amount of packing volume, less weight at liftoff relative to great amount of resultant space, etc., are important characteristics dictating further promotion of the technology. Adding the use of rigidizing foam to enhance the structural integrity is of considerable value added.

The results of this design analysis indicate the concept is very feasible from habitability, human factors, and environment-behavior considerations. The PSSMS structure is easily able to be made habitable. The torus versus the inner part of the ellipsoid allows easy separation of work from living areas. The two floor possibility in the ellipsoid allow separation of public crew support spaces from private crew quarters. Orientation and circulation are clear. Translation pathways allow for unobstructed movements of components and crew. Dual egress is assured. Variety of space within tight quantitative space limitations is accomplished. Creating two separate environments within one envelope—the torus and the domed center of the ellipsoid—lessens the number of materials interfacing with one another. In sum, the concept seems extremely feasible and deserves most serious exploration by the various lunar program offices at NASA.

7.2 CRITICAL DESIGN FEATURES OF *DYMAXION*

The efficiency of Fuller's design of "dymaxion" has been the driver for this lunar base concept. Zoning takes precedence here as the habitat is divided into two spatial delineations: work and habitation. Initially, the habitat is erected and protected using a telerobotic system. This phase of construction allows for the habitat construction to be well underway by the time the crew arrives, eliminating EVA time. The exact technology

for the successful deployment of the initial phase is yet to be discovered, and the preparation of the site will involve equipment currently under study.

Simplicity in design is addressed in the fact that the entire habitat can be delivered to the surface of the Moon in only three anticipated payloads.

The key components of *Dymaxion* are three space station Freedom-type modules, a mission control hub, and a mast containing the structural components for regolith shielding, vertical circulation, and life support systems and environmental controls.

The work environment dominates the lower portion of the base within the hard modules. Each module is connected to the mission control hub, radiating outward and terminated with an airlock. These features provide for redundant means of egress. Six EMUs are located in each module, and in the event of a module failure, there are still enough EMUs for the entire crew.

The protective system for radiation shielding is deployed by robotics. Regolith is translated upward through the mast, and unloaded onto the Kevlar canopy. This necessitates machinery that only needs to remain upon the surface of the Moon. The canopy is sloped to correspond to the angle of repose of the regolith. With the canopy, access is gained to the modules underneath, eliminating the need to uncover a module buried directly.

A spherical geometry houses the habitation portion of the base. Volumes within this space are generous, allowing for movement of the interior components. Crew quarters contain sleeping accommodations for 3 crewmembers each. The quarters are located centrally, and this location allows for the quarters to serve as a safe haven in the event of an emergency.

The balance of the spherical shape is dedicated to crew support. The recreation area takes advantage of the ceiling form, e.g., projecting images on the interior skin for videos, communications etc. The upper deck area also offers an overlook balcony, creating a visually expansive vantage point.

7.3 MAJOR STRENGTHS AND LIMITATIONS OF *DOMUS I*

With the technology of inflatables still in the discovery stage, we have developed the habitat under the assumption that living within a pressurized, reinforced-fabric envelope is not only feasible, but most practical. What remains to be determined is the method of packaging the envelope and what is the best strategy to deploy the habitat on the surface of the Moon.

The separation of work and relaxation is vital to the well-being of the crewmembers. It is a feature found in terrestrial architecture and allows the human being time to refresh and regroup. As productivity is a major component in the success or failure of a mission, creating a positive work environment is essential. Related to this issue is the design of personal quarters. We agree with various aerospace professionals who encourage spaces be designed that will allow a crewmember to be alone for some period of time. Space has been allotted for the crew to personalize their territory, not only in their quarters, but also in workstations.

The construction method of the habitat has not been perfected. Yet, it appears that the construction may be relatively easy to achieve. Site preparation that requires little EVA time for the crew will be beneficial.

Outfitting the interior of the habitat in a shirt-sleeve environment will permit the crew to work without the bulk of spacesuits. There are few components to the entire facility. This fact will allow for easy expansion at the airlock locations. Fewer components means fewer interfaces or potential points of failure.

Another feature of *Domus I* addresses the visual and spatial variety of the habitat. Though there are only three major levels of operation, the laboratories, crew quarters, and crew support levels are designed with spaces that flow and blend with one another, while being distinctly different in style and character.

The volume of the habitat is not expansive, yet every effort has been made to have the geometry appear as though it is. When coupled with the component system flexibility, these spaces should serve a wide variety of individuals who will inhabit the facility during their tours of duty.

The limitations of *Domus I* lie in the unproven technology of the construction methods and materials. The construction process will demand the use of various types of equipment yet to be developed. In the interior portion of the habitat, further testing will be required to evaluate locomotion within a torus (in 1/6 g). Postoccupancy evaluation (POE) will be vital as lunar bases of the future are constructed and inhabited for any length of time.

7.4 MAJOR STRENGTHS AND LIMITATIONS OF *DYMAXION*

Dymaxion strives to produce a lunar habitation facility that can be simply deployed without great risk to the crewmembers' lives. Compact packaging is the goal, with the maximum allowable components placed within a known-technology container. A combination of both hard module and inflatable technology will allow for a range in construction testbed experimentation. The spatial variety offered in these geometries will provide the crew with various options for workstation configuration and personalization. It is known that an inflatable envelope can offer a large working volume; yet to be determined is the successful packing of the envelope, and equipment capable of the desired deployment—without human intervention, the robotic assembly might need a form of artificial intelligence.

A cause for concern will be the deployment of the regolith for shielding. Introducing the regolith into the interior of the mast may result in the fine

powder contaminating many of the surfaces and connections. It is known that regolith has a charge that complicates its elimination.

An additional consideration is the varied connections utilized to combine the habitat components. The connections between hard module and platform, hard module and mission control hub, those between platform and inflatable, inflatable to the mast, mast to the cupola, and mast to the regolith deployment system demand numerous forms of technology. The simplicity of the concept is diminished with the complexity of the connectors. Advances in technology may eliminate these concerns.

Lastly, with the amount of generous volume available, individual crew quarters could be available. The sharing of the crew quarters by three crewmembers reduces the amount of private space allotted and personalization possible per crewmember. As well, space dedicated to balconies may prove ineffective cost-wise.

7.5 FUTURE RESEARCH AND DESIGN DEVELOPMENT

There remain numerous issues that have not been resolved when considering the design and construction of a lunar base. Some of the issues may not have a conclusion until the actual facility is in operation, and fine tuning can occur. Some of the issues will have terrestrial analogs, and these should be studied carefully, applying appropriate parameters to the lunar concept.

Site planning and base master planning: there exist too few close up details regarding the lunar surface to select one site for construction. Further reconnaissance must be accomplished prior to choosing a final site. As well, determination must be made as to whether the site for the FLO will be the site for a permanent facility. Scientists would like to take advantage of multiple FLO sites to gather widespread data for evaluation. Does a permanent facility begin to satisfy that desire? Additionally, the aerospace and scientific communities need to develop mutual strategies for gathering the data.

Construction technology: terrestrial methods may offer suggestions on how to accomplish a portion of the necessary construction. Given the change in gravitational pull, though, equipment will either have to be adapted or completely redesigned. Construction methods to prepare the site as well as build the facility need to be evaluated.

Materials: the two concepts in this report make use of inflatable technology. Materials engineering needs to advance with further testing accomplished prior to deciding what material is appropriate for the Moon. Strict use of inflatables may not be the best strategy — a combination of inflatable and hard module design may be best. Further evaluation and testing of the two methods is warranted. There may well be a hybrid alternative yet to be designed.

Geometries: the most appropriate geometry for a vacuum environment has yet to be determined. These forms are dependent upon the material utilized. Toroids, spheres, and cylinders dominate current thought. Each has inherent challenges in outfitting the interior volume. Given the expense and weight involved in transport, these geometries will be modest. Research must continue on which geometry will offer the greatest volume, flexibility, and allow the human a productive environment.

Modular component systems: practically speaking, modular components allow for flexibility, change-out, and adaptive reuse. Questions have been raised as to whether modular systems used extensively will lead to an environment that is sterile and monotonous. A modular system can be designed to allow for not only the entire “rack” to be changed, but the smaller portions of the system can be reconfigured. Panels can be switched, reversed, removed, etc. This flexibility is an asset for the crew. Modular systems for particular geometries need further research and development.

Interior configurations: space is at a premium and designs cannot afford to waste any portion. Dependent upon the geometry, configurations need to be flexible and efficient. The lunar gravity alters human movement through space. Configurations need to address that change, and assist the crewmember in translating from place to place.

Volumetric requirements: careful study needs to be conducted addressing volumes for habitat and laboratory spaces. There exist many suggested measurements - ranges from 227 m², 349 m², 552 m², to over 1800 m². This range indicates that the optimal volume has not been discovered. Further research must be conducted to reduce this range to a more closely-related group of figures. Additionally, will the volumes change as the missions lengthen and crew sizes increase?

Life support systems: both projects did not address these systems in this report. These need to be evaluated closely with determinations made for volumetric requirements.

Connections: design concepts and evaluations need to be conducted regarding the interface between like and unlike materials.

Interior components such as bounding platforms need to be evaluated; the discussion continues as to their merit in 1/6 g — whether or not the platforms or possibly stairs are more appropriate.

An efficiency analysis must be conducted against other proposals for lunar habitats with application proceeding to cost analysis.

Laboratory analysis must be conducted and determinations made as to whether the scientific functions on the lunar surface can share equipment, lab spaces, and we must understand how these laboratories would function in the lesser gravity.

The dynamics of small group interaction should be evaluated, especially groups in isolation and confinement. These dynamics can then be related to the design process.

Noise and vibration control and abatement needs to be researched, especially when considering the use of multiple types of materials.

Lighting and energy requirements should be closely examined and a full illumination analysis should be conducted on the base concepts.

As with laboratories, the medical facility needs further investigation, not only in the design but in understanding the functioning of medical practice in lowered gravity. The extent to which medicine will be practiced needs to be delineated, from triage to recuperation.

The packaging concepts and delivery to the surface of the Moon demand closer examination. Simply creating a concept for experimentation and habitation will not evaluate the entire picture. Future launch and delivery systems must be examined in parallel when conceptualizing extraterrestrial habitats.

The list of future research topics is complex and extensive. Priorities need to be established, and the level of depth to which lunar concepts are examined will demand close interaction with the aerospace community. The UW-Milwaukee Space Architecture Design Group continues its involvement in designing concept designs and design development for various architectures for the Moon and Mars. We welcome evaluation and critique from traditional architectural professionals and members of the aerospace community.

References

- Alred, J., Bufkin, A., Kennedy, K., Petro, A., Roberts, M., Stecklein, J., & Sturm, J. (1989). *Lunar Outpost*. Washington, D.C.: NASA Advanced Programs Office.
- Capps, S. & Moore, N. (1989). Partial gravity habitat study, with applications to lunar base design. Unpublished report, Sasakawa International Center for Space Architecture, College of Architecture, University of Houston.
- Carpenter, J. (1992, June). First Lunar Outpost: Detailed Assumptions (Working Drafts). Houston: NASA Johnson Space Center, Exploration Programs Office, Mission Analysis and System Engineering.
- Carpenter, J. (1992, June). First Lunar Outpost: Requirements and Guidelines (Working Draft). Houston: NASA Johnson Space Center, Exploration Programs Office, Mission Analysis and System Engineering.
- Chow, P. Y. (1992) Construction of pressurized, self-supporting membrane structure on Moon. *Journal of Aerospace Engineering* 5(3), 274-281.
- Connell, R., Fieber, J., Paruleski, K., & Torres, H. (1990) Design of an inflatable habitat for NASA's proposed lunar base. Unpublished report. NASA/Universities Space Research Association, Summer Internship Report.
- Harris, J.R. (1991). *Airlocks: A study of previous use, technology and planet surface systems requirements*. Contract NAS 9 - 17900. Lockheed Engineering & Sciences Company, Houston, TX.
- Kaplicky, J. and Nixon, D. (1983). Future systems - the bubble. *Architecture and Urbanism* (8812). Pp.96.
- Kanas, N. (1993). In space, on your nerves - you have to get along to go along to the stars. *Ad Astra*. May/June 1993. Pp. 30-33.
- Kline, R., Mc Caffrey, R., & Stein, D. (1989). Potential designs of space stations and platforms; *Space Stations and Space Platforms — Concept, Design and Construction*. Pp. 298-302.
- Laudon, K.C., and Laudon, J.P. (1991). *Business Information Systems*. Dryden Press. Illinois. Pp. 5.
- Mero-Raumstruktur GmbH & Co. (1983). *Meroform Construction System M-12: Design, Structure and Technique*.
- Moore, G.T. & Rebholz, P.J. (1992). Aerospace architecture: A comparative analysis of five lunar habitats. Paper presented at the American Institute of Aeronautics and Astronautics 1992 Aerospace Design Conference, Irvine, CA., February, Paper AIAA 92-1096.
- National Aeronautics and Space Administration (1993). Internet: Telnet Spacelink, Marshall Space Flight Center. *Multifunction CRT display system*.
- National Aeronautics and Space Administration (1993). Internet: Telnet Spacelink, Marshall Space Flight Center. *Smoke detection and fire suppression*.
- National Aeronautics and Space Administration (1993). Internet: Telnet Spacelink, Marshall Space Flight Center. *Tank pressure control experiment/thermal phenomena*.
- National Aeronautics and Space Administration (1993). Internet: Telnet Spacelink, Marshall Space Flight Center. *Tracking and data relay satellite system*.
- National Aeronautics and Space Administration (1993). Internet: Telnet Spacelink, Marshall Space Flight Center. *Voice command system*.
- National Aeronautics and Space Administration (1987/1989). *Man-systems integration standards: NASA STD 3000, Vol 1 (Rev. A, 1989)*. Washington, D.C.: NASA.
- Nealy, J.E., Wilson, J.W., & Townsend, L.W. (1988). Solar-flare shielding with regolith at a lunar base site. NASA - Langley Research Center, Hampton, VA.
- Perkinson, D., Adams, A., et al. (1992, May). First Lunar Outpost: Lunar Habitat Documentation. Huntsville, AL: NASA Marshall Space Flight Center.

Ramsey, P.S. (1991). Lubricant and seal technologies for the next generation of lunar roving vehicles. Boeing Defense and Space Group, Huntsville, AL.

Ramsey, C.G., and Sleeper, H.R. (1989). Architectural Graphic Standards. Student Edition. New York: John Wiley & Sons.

Sanders, M.S. and McCormick, E.J. (1987). *Human Factors in Engineering and Design*. McGraw-Hill, Inc. California. Pp. 4.

Sasakawa International Center for Space Architecture (SICSA) (1989). *Astrotechtonics*. 2(2). SICSA, College of Architecture, University of Houston, Pp. 8-9.

Sherwood, B., and Toups, L. (1992). Technical issues for lunar base structures. *Journal of Aerospace Engineering* 5(2).

Shiva, S.G. (1991). *Computer Design and Architecture*. Harper Collins Publishers, Inc. New York. Pp. 351; 422-430.

Steffy, G.R. (1990). *Architectural Lighting Design*. New York: Van Nostrand Reinhold Company.

Stuster, J. (1987). Habitability during long-duration space missions: key issues associated with a mission to Mars. In C.R. Stoker (Ed.) *The Case for Mars III: Strategies for Exploration - General Interest and Overview: Proceedings of the 3rd Case for Mars Conference*. San Diego, CA: Univelt. Pp. 181-191.

Tanenbaum, A.S. (1976). *Structured Computer Organization*. Prentice Hall. New Jersey. Pp. 60-62.

Thangavelu, M. (1991) MALEO: Modular assembly in low Earth orbit — Alternate strategy for lunar base development. *Journal of Aeronautical Engineering* 4(3), 256-273.

Vanderbilt, J.D., Criswell, M.E., & Sadeh, W.Z. (1988). Structures for a lunar base. In S.W. Johnson & J.P. Wetzel (Eds.) *Engineering, Construction, and Operations in Space: Proceedings of Space 88*. New York: American Society of Civil Engineers. Pp. 352-374.

Vaniman, D., Reedy, R., Heiken, G., Olhoeft, G., & Mendell, W. (1991). The Lunar Environment. In G.H. Heiken, D.T. Vaniman and B.M. French (Eds.) Lunar Sourcebook — A User's Guide to the Moon. Cambridge: Cambridge University Press. Pp. 27-60.

Walden, B. (1989). *Special report: Regolith*. Oregon L-5 Society, Inc.