

THE ROLE OF SULFUR METABOLISM IN EFFECTIVE  
PLANT-MICROBE INTERACTIONS

By

Justin J. Speck

A Dissertation Submitted in

Partial Fulfillment of the

Requirements for the Degree of

Doctor of Philosophy

In Biological Sciences

At

The University of Wisconsin-Milwaukee

August 2015

# Abstract

## The Role of Sulfur Metabolism in Effective Plant- Microbe Interactions

By  
Justin Speck

The University of Wisconsin-Milwaukee, 2015  
Under the Supervision of Dr. Gyaneshwar Prasad

*Bradyrhizobium japonicum* USDA110 and *Sinorhizobium meliloti* RM1021 are nitrogen fixing rhizobia that fix nitrogen when in a symbiotic relationship with legumes. For effective nitrogen-fixing symbiosis to occur these rhizobia must differentiate into nitrogen-fixing bacteroids. This involves the production of high levels of sulfur rich nitrogenase as well as other sulfur containing compounds, creating a large demand for sulfur. This work examined the role of organic sulfur in the establishment of symbiosis and viability of rhizobia in plant nodules.

Disruption of the sulfonate sulfur utilization gene *ssuD* in both *Bradyrhizobium japonicum* USDA110 and *Sinorhizobium meliloti* RM1021 resulted in a strong nitrogen deficient phenotype in the host plants. This phenotype was linked to a reduced ability to invade host plants as a result of increased sensitivity to oxidative stress. Additionally, once inside the plant nodules, the *ssuD* mutants were slow to grow with no observable nitrogen fixation occurring. However, the ability of *ssuD* mutants to continue to grow at

slow rates in nodules resulted in the discovery that sulfate esters are another important sulfur source during symbiosis.

*Dickeya dadantii* 3937 is a phytopathogen, which causes disease in potato, maize, banana, and pineapple as well as ornamental house plants and a wide range of subtropical and tropical plants. *D. dadantii* has been used as a model organism for the study of secretion systems and virulence factors in phytopathogens. This work examined the regulation, induction, and role of organic and inorganic sulfur utilization genes during the infection of potato by *D. dadantii*.

The regulation of sulfur metabolism in *D. dadantii* was determined to be similar to the model organism *Escherichia coli*. However, disruption of the arylsulfatase operon slowed the spread of maceration in potato infections despite *D. dadantii* being unable to grow on arylsulfonates. Examination of the arylsulfatase operon resulted in the discovery of a phenol dependent sulfotransferase that was able to sulfonate salicylic acid and is hypothesized to play a role in subverting salicylic acid induced immunity in host plants.

# Table of Contents

<b>Title</b>	<b>Page</b>
<b>Title Page</b>	<b>i</b>
<b>Abstract</b>	<b>ii</b>
<b>Table of Contents</b>	<b>iv</b>
<b>List of Figures</b>	<b>vii</b>
<b>List of Tables</b>	<b>xiii</b>
<b>Acknowledgments</b>	<b>xiv</b>
<b>Chapter 1</b>	<b>1</b>
Plant and Microbe Interactions	1
Symbiosis	2
Biological Nitrogen Fixation	8
Virulence	11
Importance of Sulfur	14
Sulfur Regulation	21
<b>Chapter 2</b>	
<b>Determining the Role of Organic Sulfur Utilization in Rhizobia-Legume Symbiotic Nitrogen Fixation</b>	<b>23</b>
<b>Introduction</b>	<b>24</b>
<i>Bradyrhizobium japonicum</i> USDA110	25
<i>Sinorhizobium meliloti</i>	29
<b>Methods and Materials</b>	<b>34</b>
Strains, Plasmids, and Growth Conditions	34

Construction of $\Delta ssuD$ Mutant	38
Sulfur Source Utilization Experiments	38
Rhizobial Colonization of Host Plants	39
Quantitative Plating of Viable Colonized Rhizobia	39
Chlorophyll Content and Dry Weight of <i>Bradyrhizobium japonicum</i> Colonization Experiments	40
Acetylene-Ethylene Reduction Assay	41
Confocal Imaging of Host Plant Colonization	41
Histochemical Staining for Sulfatase Activity	42
$\beta$ -Galactosidase Assay	43
GFP/OD <sub>600</sub> Gene Induction Experiments	43
H <sub>2</sub> O <sub>2</sub> Growth Experiments	44
<b>Results</b>	45
<i>Bradyrhizobium japonicum</i> Utilizes both Organic and Inorganic Sulfur as a Sole Sulfur Source	45
The Gene <i>ssuD</i> is Required for Utilization of Sulfonates in <i>B. japonicum</i>	47

Soybean Inoculated with <i>B. japonicum</i> $\Delta$ <i>ssuD::kan</i> Has a Nitrogen Deficient Phenotype	48
$\Delta$ <i>ssuD::kan</i> -inoculated Plants Display Morphological Differences in Root Nodules	52
The $\Delta$ <i>ssuD::kan</i> Mutant is Defective in Root Colonization	60
Expression of <i>B. japonicum</i> Sulfatase Genes in Nodules	73
Organization and Annotation of <i>bll4740</i> Operon	75
Sulfatase Activity is Required for Effective Nitrogen-Fixing Symbiosis	77
Nodule Phenotype in $\Delta$ <i>bll4740::kan</i> Inoculated Plants	81
Sulfur Utilization in <i>Sinorhizobium meliloti</i> RM1021	85
Expression of Sulfate Binding Protein and Taurine Transport Genes in Free Living Conditions	86
Role of Sulfonate Utilization in <i>S. meliloti</i> Symbiosis	93
<b>Discussion</b>	104
<b>Chapter III</b>	
<b><i>Dickeya dadantii</i> 3937, a Soft Rot Causing Phytopathogen, utilizes a Phenol Dependent Sulfotransferase during Infection of Potato</b>	114
<b>Introduction</b>	114
<b>Methods and Materials</b>	118
Bacterial Strains and Growth Conditions	118

Construction of Promoter-GFP Reporter Fusions	121
Construction of Operon Mutants	121
Operon Expression Assays	122
Potato Infection Assay	122
Potassium 4-Nitrophenyl Sulfate (PNPS) Assay	123
<b>Results</b>	124
Sulfur Utilization in <i>Dickeya dadantii</i> 3937	124
Expression of Sulfur Genes In Response to Sulfur Conditions	126
Sulfotransferases are Required For Infection of Potato	131
<b>Discussion</b>	138
<b>References</b>	141

# List of Figures

<b>Figure</b>	<b>Description</b>	<b>Page</b>
<hr/> <b>Chapter I</b>		
1	Rhizobia Root Invasion	6
2	Stoichiometry of Biological Nitrogen Fixation	9
3	Structure of Nitrogenase	10
4	Sulfur Containing Amino Acid Production	16
5	Sulfur Acquisition and Utilization Pathways	19
6	Model of Sulfonate and Taurine Utilization	20
7	Regulation of Alternative Sulfur Utilization Genes	22
<hr/> <b>Chapter II</b>		
8	Homologies between the <i>ssuD</i> Genes of <i>B. japonicum</i> and <i>E. coli</i>	27
9	Internal Structure of Indeterminate Nodules	31
10	Fusion Reporter Strain Construction	32
11	Growth of <i>Bradyrhizobium japonicum</i> on Sole Sulfur Sources	46
12	Growth Curve of <i>B. japonicum</i> on Sulfate and HEPES as Primary Sulfur Sources.	46
13	Growth of Wild Type and the $\Delta$ <i>ssuD</i> : <i>kan</i> Mutant on Different Sulfur Source	47

<b>Figure</b>	<b>Description</b>	<b>Page</b>
14	Leaflets from Wild Type, $\Delta ssuD::kan$ , and Uninoculated Soybean	49
15	Soybean ( <i>Glycine max</i> ) Inoculated with Wild Type <i>B. japonicum</i> (Left side) and $\Delta ssuD::kan$ Mutant <i>B. japonicum</i> (right side)	49
16	Dry Weights of Wild Type and $\Delta ssuD::kan$ -inoculated Plants	51
17	The Chlorophyll Content of Soybean Leafs Assayed	51
18	Average Number of Nodules per Plant in Soybean Inoculated with Wild Type and $\Delta ssuD::kan$ Mutant	53
19	Roots from Wild Type and $\Delta ssuD::kan$ Mutant Inoculated Plants	55
20	Size Comparison of Wild Type and $\Delta ssuD::kan$ Nodules	56
21	Nodule Counts from Wild Type and $\Delta ssuD::kan$ -inoculated Plants	56
22	Images of Wild Type and $\Delta ssuD::kan$ Colonized Nodules	57
23	Acetylene-Ethylene Assay	59
24	Colony Counts per Gram of Nodule	61
25	Confocal Images of GFP Marked Wild Type <i>B. japonicum</i> (A and B) and $\Delta ssuD::kan$ <i>B. japonicum</i> (C and D)	63
26	Scanning Electron Microscopy Images of Wild Type (Left) and $\Delta ssuD::kan$ Mutant (Right) Inoculated Nodules	64
27	Competition Studies Between Wild Type and $\Delta ssuD::kan$ Mutant	66

<b>Figure</b>	<b>Description</b>	<b>Page</b>
28	Confocal Microscopy Images of $\Delta ssuD::kan$ and Wild Type <i>B. japonicum</i> Entering Through Root Hairs	68
29	Sensitivity to Oxidative Stress	70
30	Confocal Image of Wild Type (A) and $\Delta ssuD::kan$ (B) Inoculated Nodules	72
31	Wild Type <i>B. japonicum</i> Inoculated Nodules Stained with X-Sulfate	74
32	Wild Type and <i>bll4740</i> Transposon Mutant 4-16 on Minimal Media with X-sulfate	76
33	Wild Type and $\Delta 4740::kan$ Mutant on Minimal Media with X-SO <sub>4</sub>	76
34	Image of Leaves from $\Delta bll4740::kan$ Inoculated Plant and Wild type-inoculated Plant	78
35	Whole Soybean Plants Inoculated with $\Delta bll4740::kan$ and Wild Type <i>B. japonicum</i>	78
36	Dry Weights from Wild Type and $\Delta bll4740::kan$ Inoculated	79
37	Measurement of Chlorophyll Content for Wild Type and $\Delta bll4740::kan$ Mutant Inoculated Plants	80
38	Comparison of Wild Type and $\Delta bll4740::kan$ Mutant Inoculated Roots	82
39	Nodules from Wild type-inoculated (A and C) and $\Delta bll4740::kan$ Mutant Inoculated (B and D) Plants Stained with X-sulfate (A and B) and Unstained (C and D)	84
40	Growth of <i>S. meliloti</i> on Multiple Sulfur Sources	85
41	PNPG Assay of <i>sbp-gusA-rfp</i> Strain in Different Sulfur Conditions	87
42	PNPG Assay of <i>tau-gusA-rfp</i> Strain in Different Sulfur Conditions	88

<b>Figure</b>	<b>Description</b>	<b>Page</b>
43	Construction of Reporter Fusions for <i>tau</i> and <i>sbp</i> Operons	90
44	Fusion Strain Inoculated Alfalfa Stained with X-Gluc	90
45	Confocal Images of <i>tau-gusA-rfp</i> and <i>sbp-gusA-rfp</i> Reporter Fusions in Alfalfa	92
46	Construction of Reporter Fusions for <i>SM_b20569</i> and <i>ssu</i> Operons	94
47	Growth of Wild Type vs. $\Delta$ <i>ssuD::gfp-lacZ</i>	94
48	Expression of <i>ssuD</i> in Different Sulfur Conditions	96
49	Induction of <i>SM_b20568-gfp-lacZ</i> in Different Sulfur Sources	96
50	Sulfur limitation Phenotype in Sulfonate Mutant Inoculated Alfalfa	98
51	Nodules from Wild Type and $\Delta$ <i>ssuD::gfp-lacZ</i> Inoculated Alfalfa	99
52	Confocal Images of <i>SM_b20568-gfp-lacZ</i> and $\Delta$ <i>ssuD::gfp-lacZ</i> Strains with Alfalfa	101
53	Induction of <i>ssuD</i> in Response to Oxidative Stress	103
<hr/>		
<b>Chapter III</b>		
54	Plant Immune Response	116
55	Growth Curve of <i>D. dadantii</i> in Different Sulfur Sources	125
56	Sulfur Utilization Genes	125
57	Expression of the <i>sbp</i> Operon in Different Sulfur Sources	127

<b>Figure</b>	<b>Description</b>	<b>Page</b>
59	Expression of <i>cysGDNC</i> Operon in Different Sulfur Sources	129
59	Induction of <i>ssu</i> Operon in Different Sulfur Sources	129
60	Induction of <i>ats</i> Operon in Different Sulfur Sources	130
61	Growth of $\Delta$ <i>ssu::kan</i> vs. Wild Type in Different Sulfur Sources	131
62	Infection of Potato by Wild Type and Mutant Strains of <i>D. dadantii</i>	133
63	Phenol Dependent Sulfotransferase Activity in Different Concentrations of Phenol	135
64	Activity of Phenol Dependent Sulfotransferase Under Sulfur Limited Conditions	135
65	Utilization of Salicylic Acid by Phenol Dependent Sulfotransferase	137

## List of Tables

<b>Table</b>	<b>Description</b>	<b>Page</b>
1	Strains, Plasmids, and Primers Used in the <i>Bradyrhizobium japonicum</i> and <i>Sinorhizobium meliloti</i> Study	35
2	Strains, Plasmids, and Primers Used in the <i>Dickeya dadantii</i> Study	119

# Acknowledgements

I thank Dr. Gyaneshwar Prasad for giving me the opportunity to work under him on my Ph.D. and I appreciate his effort in ensuring financial support for me throughout the duration of my graduate studies. I also thank my graduate committee members Dr. Ching-Hong Yang, Dr. Chuck Wimpee, Dr. Daad Saffarini, and Dr. Sergei Kuchin for their valuable guidance in research. I would also like to thank Dr. Michael Sadowsky from University of Minnesota for the *Bradyrhizobium japonicum* USDA110 strain and pLAFR vector; Dr. Turlough M. Finan from McMaster University for the *Sinorhizobium meliloti* RM1021 fusion strains; And Dr. Ching-Hong Yang from University of Wisconsin Milwaukee for the *Dickeya dadantii* 3937 strain.

I would like to thank my wife and children for being a great support to me throughout graduate school. I would also like to thank my parents and siblings for their support. Finally, I would like to thank my lab mates Dr. Mitra, Dr. Das, and Dr. Shah for their friendship and help in and out of the lab.

# Chapter 1 Introduction

## Plant and Microbe interactions

Plant health is highly dependent on plant associated microorganisms. Mutualistic interactions can develop between plants and microbes, such as the symbiosis of rhizobia and legumes, for the acquisition of nutrients and hormonal stimulation. However, plant health can be negatively affected by antagonistic plant-microbe interactions when phytopathogens invade, causing disease (Whipps, 2001). All plants have these potentially beneficial or harmful interactions with microorganisms, and aspects of these interactions, beneficial and harmful, have garnered extensive study. Due to the potential benefits of harnessing and controlling plant microbe interactions, a strong market has developed for growth-promoting microbial inoculants and microbial biocontrol agents, for suppression of disease (Berg, 2009).

Symbiotic relationships between plants and microorganisms are required for the effective acquisition of macronutrients, such as nitrogen and phosphorus, which often limit plant growth. The most common symbiotic relationship in plants is with mycorrhizal fungi for the acquisition of phosphorus. Additionally, a smaller group of plants, mainly legumes, have evolved to have a symbiotic relationship with rhizobia for the acquisition of nitrogen. This legume-rhizobial symbiosis has been studied extensively over the past several decades in the hopes of replicating and expanding this symbiotic interaction to agriculturally important non-legumes (Anthamatten et al. 1992; Kouchi et al. 2004; Oldroyd and Downie, 2008; Putnoky et al. 1988; Ruvkun and

Ausubel, 1979; Yang et al. 1994). Genetic analysis of the symbiotic relationship between *Sinorhizobium meliloti* with alfalfa and *Bradyrhizobium japonicum* USDA 110 with soybeans has provided important details about the mechanism of rhizobial-legume interactions that lead to nitrogen fixing symbiosis.

Conversely, antagonistic plant-microbe interactions cause human suffering through food shortages and economic loss. Protection of crops from disease would significantly improve agricultural production (Baker et al. 1997). Phytopathogens utilize several different virulence factors to cause disease in host plants. Symptoms from these virulence factors include soft rots, scabs, cankers, wilts, leaf spots, specks and galls (Ellis et al. 2008). Research into these pathogens has aided in remediation of many of these bacterial caused diseases by creating genetic host resistance, chemical applications, and biological controls. Despite these steps in limiting bacterial pathogens, they continue to plague food production, thus prompting the need for continued research into preventing the spread of plant pathogens.

## Symbiosis

The acquisition of nitrogen is the key factor behind the development of symbiosis between legumes and rhizobia. Nitrogen is a macronutrient required by all organisms for growth. While nitrogen makes up 80% of the Earth's atmosphere, it is inaccessible to most organisms. Thus, nitrogen is often the limiting nutrient for growth. The productivity of agricultural crops is directly dependent on the availability of fixed nitrogen. With an ever- growing population, higher agricultural yields are required and

thus, more fixed nitrogen is required to produce these high yield crops than is naturally available in soils. There are two main ways of replenishing fixed nitrogen (ammonia): chemical nitrogen fixation and biological nitrogen fixation. Developed countries have been using chemically fixed nitrogen since the 1950s, while much of the developing world has been reliant on biological nitrogen fixation from forage legumes (Herridge et al. 2008).

The main concern from nitrogen fertilizers is the nitrogen runoff into lakes, rivers, and coastal waters. Eutrophication is the result of excess nutrients promoting the growth of large algal blooms which consume dissolved oxygen and create hypoxic conditions. These hypoxic conditions result in the death of fish and other marine life and, in some cases, create large uninhabitable zones. Seventeen thousand sq miles of the Gulf of Mexico has become uninhabitable due to hypoxic conditions resulting from nitrogen runoff (Ribaud et al. 2001). Due to these increasing environmental problems, developed countries are trying to move away from chemically-fixed nitrogen to biological nitrogen fixation.

Biological nitrogen fixation is carried out by microorganisms called diazotrophs. The most studied group of diazotrophs is the Rhizobia, which fix nitrogen when in symbiotic organs called nodules that form on the roots of legumes. Symbiosis between legumes and rhizobia is a complex, multistep process involving host specific chemical signaling. Initially, plants exude flavonoids, dicarboxylic acids, and amino acids that elicit a positive chemotactic response and the production of signaling molecules in rhizobia (Rhijn and Vanderleyden, 1995; Barbour et al. 1991). Rhizobia begin producing molecules called nodulation (Nod) factors in response to plant-exuded flavonoids and

isoflavonoids. This exchange of chemical signals (flavonoids and nod factors) results in changes to global gene expression of both rhizobia and plant (Kouchi et al. 2004; Mesa et al. 2008; Karunakaran et al. 2009; Delmotte et al 2010; Schmutz et al. 2010).

Before infection can occur, the rhizobia attracted through chemotaxis must adhere to the plant roots to form a biofilm. It is hypothesized that rhizobia are able to preferentially adhere to legumes due to the lectins on new growth tissue (Hirsch, 1999). Exopolysaccharides have also been shown to play a key role in attachment of rhizobia to plant cells. *S. meliloti* with mutations in genes important for the synthesis of the exopolysaccharides cannot fully invade the root to establish infection threads, and the nodules remain uninfected (Leigh et al. 1985; Fujishige et al. 2005).

Once the Rhizobia are attached, they must invade the host by getting past epithelial cells. This can happen in two ways, either through root hairs or through cracks in the root surface (Figure 1). In both cases, Nod factors released by the rhizobia initiate infection thread formation. Infection thread formation is aided through the expression of the plant gene *rip, I* which induces an oxidative burst. This oxidative burst aids in the degradation of cells walls for the formation of the infection thread. Additionally, it is likely that the oxidative burst plays a defensive role in limiting unwanted bacterial growth in the infection thread (Passardi et al. 2004). Once inside the infection thread, the Rhizobia begin to proliferate and spread down into the cortical cells. The Nod factor signal is transduced to reach non-adjacent root cells via calcium spiking (Ehrhardt et al. 1996)

Nod-induced signaling initiates cortical cell division to form the nodule (Yang et al. 1994). Rhizobial cells are then able to spread down the infection thread into the

cytosol of cortical cells. However, the developmental processes that occur in the cortical cells to form nodules are different from those in epithelial cells that form the infection thread. Study of nodulation-defective mutants has revealed that epidermal cell responses and cortical cell responses can be induced independently, allowing for bacterial infection to occur in the absence of nodule organogenesis (Murray et al. 2007) and, conversely, nodule organogenesis to occur in the absence of bacterial infection (Gleason et al. 2006; Tirichine et al. 2006 ). Bacteria must be able to induce a response from both epithelial and cortical cells to form and infect nodules (Oldroyd and Downie, 2008).

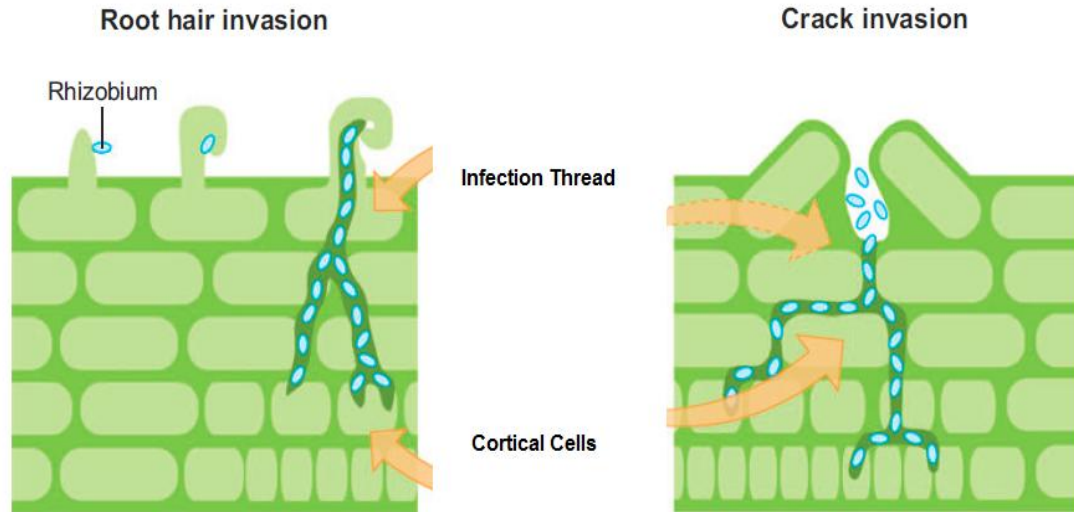

**Figure 1. Rhizobia Invasion of Legume Root**

Infection of root cells by Rhizobia can occur through root hairs or cracks in root epithelial cells. Both forms of entry require Nod factors for the formation of the infection thread and infection of cortical cells. Adapted from Oldroyd and Downie, 2008.

Rhizobia within the cytoplasm of cortical cells differentiate into nitrogen fixing bacteroids. This involves a large scale shift in rhizobia gene expression (Hoa et al. 2004). Additionally, differentiation to bacteroids in legumes involves genome amplification that is generated by endoreduplication (genome replication with no cytokinesis) cycles and correlates with enlargement of the rhizobia (Mergaert et al. 2006). The multiploid nature of the bacteroids allows for higher levels of nitrogenase gene expression. The nitrogenase enzyme becomes the most abundant protein within nodules where the fixed nitrogen is then exchanged for photosynthates and a favorable microaerobic environment for nitrogen fixation to occur.

Nodules, from legumes, are divided into two broad classifications, determinate nodules and indeterminate nodules. Formation of determinate nodules occurs by cellular division in the outer cortex, halting shortly after nodule formation. Increases in nodule size after the initial growth are due to changes in cell volume and not cell number. Subsequently, these nodules take on a spherical shape (Hirsch, 1992). Conversely, cellular division occurring in indeterminate nodules starts at the inner cortex and develops to the apical meristem and does not stop. Growth in indeterminate nodules is due to both increases in cell volume and number, giving rise to elongated nodules (Denison, 2000).

## Biological Nitrogen Fixation

Nitrogenase, an oxygen sensitive enzyme, is produced by rhizobia to fix nitrogen into ammonia. Biological nitrogen fixation by symbiotic rhizobia allows for the supply of nitrogen directly to plants in exchange for carbon and other nutrients. This is a preferable method of supplying nitrogen to crops because there is limited nitrogen pollution, and it sequesters carbon, as opposed to releasing it during chemical nitrogen fixation. Unfortunately, many agriculturally important crops are cereals which do not form a symbiotic relationship with rhizobia. Thus, biological nitrogen fixation is unable to provide enough nitrogen to meet the needs of high yield agricultural lands.

Nitrogen fixing bacteria reduce nitrogen from one nitrogen molecule to two ammonia molecules in an energy intensive enzymatic process involving nitrogenase (Figure 2). Ammonia is used by microbes and plants as a source of nitrogen. Nitrogen fixation was first studied in *Klebsiella pneumomae*, where it was shown that the nitrogenase enzyme was composed of three main structural components encoded by *nifH*, *nifD*, and *nifK* (Adams et al. 1984). Component I of the nitrogenase complex is composed of two subunits,  $\alpha$  and  $\beta$ , encoded by *nifD* and *nifK*. Component II is a dimeric reductase encoded by *nifH* (Quinto et al. 1984; MacNeil et al. 1978; Dixon et al. 1980).

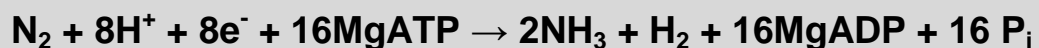

### Figure 2. Stoichiometry of Biological Nitrogen Fixation

Biological nitrogen fixation reaction for the reduction of  $N_2$  to two molecules of  $NH_3$  at a cost of 16 ATP molecules. For every molecule of nitrogen fixed, a molecule of hydrogen is fixed, greatly reducing the reaction efficiency.

Inefficiencies in the nitrogen fixation reaction can occur unless it proceeds under controlled conditions. Up to 40 molecules of ATP may be used to reduce one molecule of  $N_2$  under *in vivo* conditions. Contributing to this increased energy use is the production of a molecule of  $H_2$  for every reduced molecule of  $N_2$ . This hydrogen production has a major effect on the efficiency of symbiotic nitrogen fixation (Baginsky et al. 2002).

The two component proteins of the nitrogenase complex are designated as the Fe-protein and the MoFe-protein. The Fe-protein exists as a homodimer held together by 4 Fe atoms and organized into a 4Fe-4S cluster that passes electrons to the MoFe-protein (Peters et al. 1997). The MoFe-protein is an  $\alpha_2\beta_2$  heterotetramer (NifD NifK) that contains two unique metal clusters called the P-cluster and M-cluster. The P cluster is composed of  $Fe_8S_7$  that transfers electrons from the Fe-protein to the FeMo-cofactor. The FeMo-cofactor, M-cluster, composed of  $Fe_7MoS_9N$ , reduces nitrogen to ammonia (Palermo et al. 1984) (Figure 6).

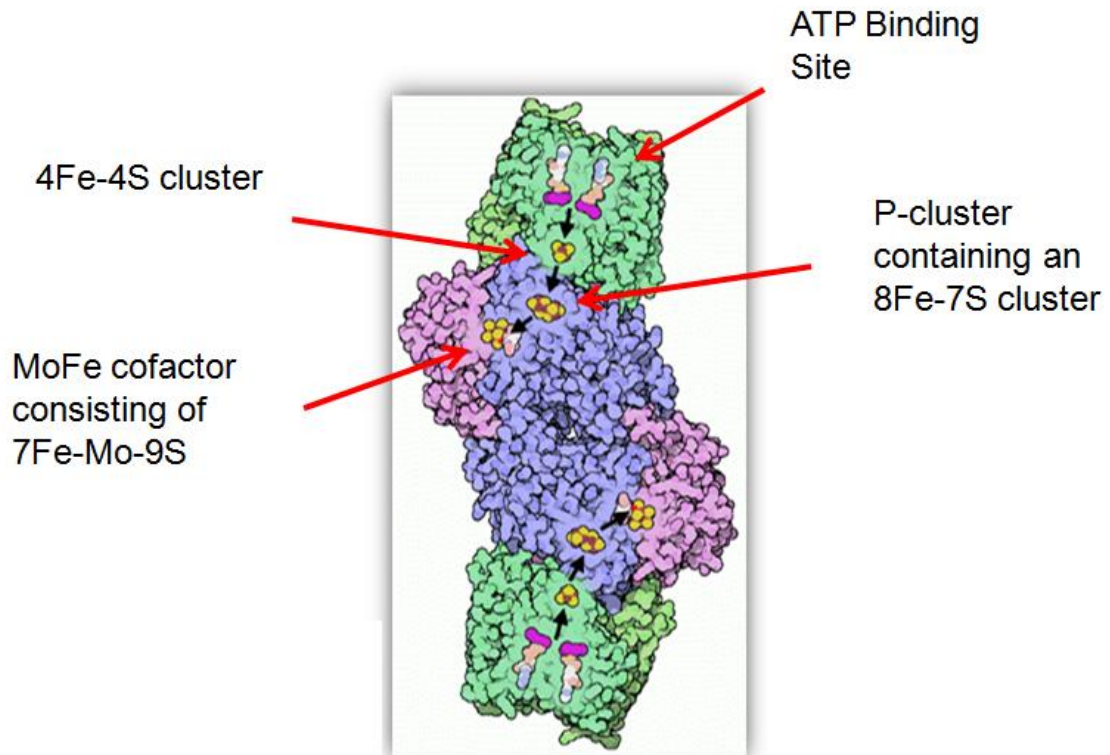

**Figure 3. Structure of Nitrogenase**

The

oxygen sensitive heteromeric nitrogenase enzyme responsible for the reduction of nitrogen. Electrons are passed from the ATP binding site through the 4Fe-4S cluster to the P-cluster and finally to the MoFe cofactor where nitrogen is reduced to ammonia (modified from Goodsell, 2002).

## Virulence

Infection of plant cells by phytopathogens is similar to plant colonization by symbiotes in that it is a multi-step process involving cross signaling. This process involves the identification of a host, induction of genes involved in infection, movement to the host, attachment, and penetration into host tissue while avoiding the host defenses. Although symbiosis and pathogenesis have very different outcomes for the plants they colonize/infect, they share the same initial goal of invading the host plant.

The invasion process is initiated by the secretion of compounds by plants that are sensed by chemoreceptors, located on the bacterial membrane (Barbour et al. 1991). The sensed signal is transduced into the bacteria where it activates the flagella for chemotaxis. This enables bacterial cells to move towards the stimuli and thus the plant (Lux & Shi, 2004). There are two different types of motility found in flagellated bacteria. Swimming motility takes place in liquid media, and swarming motility takes place on solid surfaces or in media of high viscosity (Harshey, 2003). Counter-clockwise rotation for the flagella propels the bacteria forward while clockwise rotation causes the cell to randomly tumble (Eisenbach, 1996). Runs are more frequent if the bacterium approaches a chemoattractant, and tumbles are more frequent if the bacterium is moving away from the chemoattractant (Antunez-Lamas et al. 2009).

Once the host plant has been found, the bacteria must attach to the surface of the plant. Pili or fimbriae are structures found on the surfaces of many gram-negative bacteria that mediate attachment between bacteria themselves as well as between bacteria

and host plant tissues (Vesper and Bauer, 1986). After attachment, the process of infection for symbiotes and pathogens diverges.

The infection of plant tissue occurs in cracks or abrasions in the plant epithelial tissue. For effective infection, pathogens require the coordinated production and secretion of various virulence factors (Peng et al. 2006). These factors include extracellular enzymes such as cellulase, pectate lyase, and protease (Hugouvieux-Cotte-Pattat et al. 1996; Matsumoto et al. 2003). During infection, these enzymes are secreted through a type II secretion system (T2SS) into the intercellular spaces of plant tissue, leading to the disintegration of the plant cell wall, tissue maceration, and release of nutrients. T2SS mutations can result in total loss of virulence (Beaulieu et al. 1993).

In addition to the T2SS, many Gram negative plant pathogenic bacteria have a type III secretion system (T3SS). The T3SS plays a vital role in the early stages of bacterial virulence (Keen, 1990; Lopez-Solanilla et al. 2001; Vashchenko and Hvozdiak, 2007). It has been demonstrated that T3SS mutants have greatly reduced virulence. The T3SS is a protein secretion system that allows bacteria to transfer effector molecules directly into host cells. It is composed of two major components, the cylindrical base and an extracellular filamentous appendage pilus. The cylindrical base spans the entire cell envelope and functions as a pathway for the translocation of virulence proteins across the cell membrane. The extracellular filamentous pilus functions as a syringe to direct virulence proteins directly into the host cell cytosol (Stebbins and Galan, 2003; Zeng, 2011).

Effector molecules translocated into plant tissues by the T3SS belong to two major families. The first is the Ayr proteins, believed to disrupt the host immune system

to increase pathogenicity against susceptible hosts. The Ayr proteins alter host-signaling pathways and disrupt transcription by mimicking eukaryotic enzymes (Bauer et al. 1994; Tsiamis et al. 2000; Alfano and Collmer, 2004). The second family of effector proteins is the harpin proteins. Harpin proteins are believed to be involved in modification of the plant cell wall or in the release of nutrients from plant cells (Bocsanczy et al. 2008; Collmer et al. 2002).

Alternatively, when plant pathogens invade non-host plants, they are unable to suppress the immune system. The non-host plant will have resistance genes that match the virulence genes encoding Ayr in a gene-for-gene interaction (Flor, 1971). The ability of the non-host to recognize effector molecules allows for the development of a hypersensitive response (HR), which eliminates the invading bacteria by programmed cell death and local necrosis to prevent systemic spread of the pathogen (Van der Ackercken and Bonas, 1997; Cook, 1998).

## Importance of Sulfur

Sulfur is a macronutrient required for the growth of all organisms. Sulfur is in constant oxidative flux as it cycles through the environment. Thus, it is not commonly found as a structural component of biomolecules, but rather involved in the catalytic and electrochemical functions of molecules (Leustek et al. 2000). Inorganic sulfur (sulfate) is the most commonly utilized form of sulfur. However, sulfate esters and sulfonates make up the majority of sulfur found in most soils at  $\approx 95\%$ . Therefore, only 5% of the sulfur found in soil is in the most commonly used form, sulfate (Kertesz, 1999).

The major use of sulfur is in the production of the amino acids cysteine and methionine. Cysteine is important for protein folding and structure with its ability to form disulfide bridges when oxidized. Additionally, the oxidation state of cysteine is a way to regulate enzyme function through the formation of disulfide bridges (Åslund and Beckwith, 1999). Biosynthesis of cysteine occurs after the import of sulfate into the cell. The cysteine biosynthetic pathway produces cysteine from sulfate, which is unique to plants and bacteria. Methionine is synthesized by most plants and bacteria de novo after cysteine or homocysteine synthesis. The importance of methionine is due to its use as a universal N terminal amino acid in proteins as well as its derivative S-adenosylmethionine being used in a variety of methyltransferase reactions (Rodionov et al. 2004).

The cysteine biosynthetic pathway has been well characterized in model organisms (*Escherichia coli* and *Pseudomonas aeruginosa*). The pathway begins with sulfate being imported through an ABC transporter (*cysP*, *cysT*, *cysW*, *cysA*, *sbp*) after which it is converted from  $\text{SO}_4^{2-}$  to adenosine 5'-phosphosulfate (APS) via an ATP sulfurylase (*cysD*, *cysN*) (Sekowska et al. 2000). APS kinase (encoded by *cysC*) phosphorylates APS, using a phosphate from ATP, and converting APS to 3'-phosphoadenosine 5'-phosphosulfate (PAPS). PAPS is converted to  $\text{SO}_3^{2-}$  by PAPS reductase (*cysH*). Sulfite reductase (*cysI*, *cysJ*, *cysG*) then converts  $\text{SO}_3^{2-}$  to  $\text{S}^{2-}$  by reducing sulfate with six electrons (Zeghouf et al. 2000). The final step in this pathway differs between *E.coli* and *P.aeruginosa*. In *E.coli*, sulfide and O-acetyl-L-serine are converted to L-cysteine by O-acetylserine (thiol)-lyase (*cysK*, *cysM*) and then some cysteine will be converted to methionine (Zeghouf et al. 2000). In *P.aeruginosa*, sulfide

and O-succinyl-L-homoserine are converted to L-homocysteine which can then be converted to either methionine or cysteine (Figure 4) (van der Ploeg et al. 2001). The *P.aeruginosa* model is able to produce methionine directly from sulfate allowing for more metabolic flexible than the *E.coli* pathway, which has to produce methionine from L-cysteine.

Sulfur is also a major component in a variety of enzymes and cofactors, in addition to its importance as a component of amino acids. Coenzyme A is a sulfur-containing cofactor that plays a key role in the first step of the Krebs cycle. Sulfur containing coenzyme M is involved in methane production in bacteria. Thiamine is a sulfur containing compounds whose derivatives are involved in an array of reactions, including catabolism of sugars and amino acids. The final cofactor is lipoic acid, which is a cofactor in several reactions including two of the steps in the Krebs cycle (Sekowska et al. 2000).

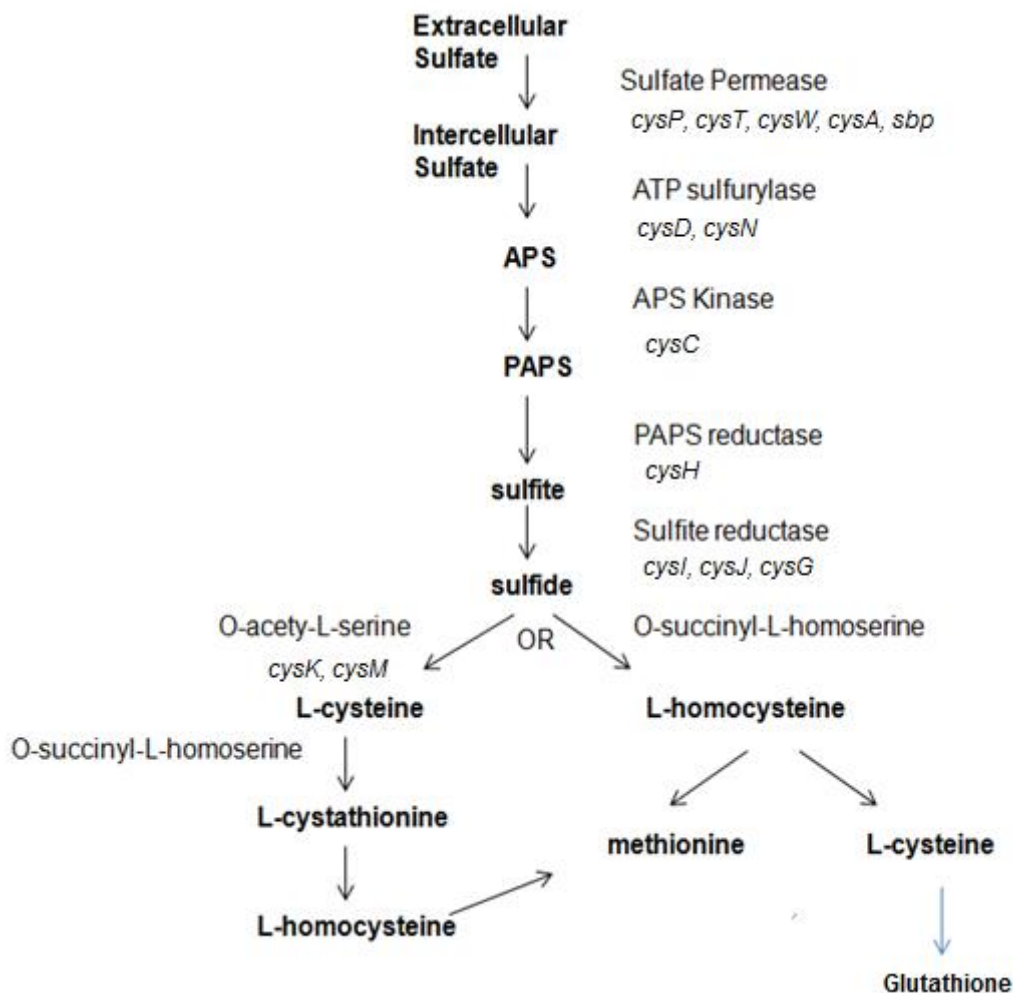

**Figure 4. Sulfur Containing Amino Acid Production**

The production of amino acids cysteine and methionine are accomplished through the cysteine biosynthetic pathway. This pathway converts sulfate to sulfite to sulfide, and finally, cysteine. Some organisms can produce methionine directly while in others methionine is a derivative of cysteine. Once cysteine is produced, it can be utilized to make many important sulfur compounds such as glutathione.

Sulfur is also an important component of signaling molecules, such as nod factors P and Q. The sulfur containing side chains in these nod factors are important for host specificity between legumes and rhizobia. Finally, sulfur is an important component in the catalytic regions of nitrogenases found in nitrogen fixing bacteria (Dean et al. 1993).

Sulfur has also been found to play a critical role in plant defense systems. Plants produce sulfur-containing defense compounds (SDC) under biotic and abiotic stress. These SDCs include elemental sulfur, H<sub>2</sub>S, glutathione, phytochelatins, various secondary metabolites, and sulfur-rich proteins (Rausch and Wachter, 2005).

In the modern age sulfur had been abundant in our atmosphere and soil due to the burning of fossil fuels. However, the increased use of low sulfur fuels and reduction in emissions has led to a reduction in the amount of atmospheric sulfur and mineralized sulfur in soils (Irwin et al. 2002). Now over 95% of sulfur found in soils is organic, with 60% of it being in the form of sulfate esters, and plants do not produce the sulfatases necessary to utilize these sulfate esters.

Most soil microbes are able to utilize alternative sulfur sources, such as sulfonates and sulfate esters, in addition to sulfate. Plants appear to be dependent on microorganisms to mobilize organic sulfur, similar to their dependence on mycorrhizal for mobilization of phosphorus (Kertesz et al. 2007). For example, the soil microbe *Pseudomonas putida* has been shown to have growth promoting effects on a wide variety of plants, which is dependent on sulfonate utilization genes (Kertesz and Mirleau, 2004).

While it has been shown that organic sulfur plays a significant role in plant growth promotion by microbes, very little is understood about the role of organic sulfur during plant-microbe symbiosis. Sulfonate utilization and sulfate ester utilization are

vital for the viability of microbes in soil, but it is unknown as to what role these sulfur sources play in the viability of rhizobia during symbiosis.

Sulfonate sulfur utilization has been studied extensively in *E. coli*, where sulfonate sulfur is utilized through the function of sulfonate sulfur utilization genes (*ssu*). This sulfur pathway has an ABC transporter (*ssuABC*), flavin-dependent monooxygenases (*ssuD*), and a flavin reductase (*ssuE*). Sulfonates are transported into the cell and reduced to sulfite by the flavin-dependent monooxygenases (Van der Ploeg et al. 1996)(Figures 5 and 6). Additionally, the sulfonate, taurine has a separate utilization pathway in some microorganisms. The taurine utilization pathway is encoded by the *tau* genes. The pathway contains an ABC transporter and monooxygenases to convert taurine to sulfite(van der Ploeg and Eichhorn, 2001) (Figures 5 and 6).

Sulfate esters are utilized by alkylsulfatases and encoded by the *ats* genes, as studied in *Pseudomonas putida* S-313 (Kahnert and Kertesz, 2000). The Sulfate ester utilization pathway contains an ABC transporter (*atsABC*), and an alkylsulfatase encoded by *atsK*, *atsA*, or *sdsA*. Sulfate esters are transported through the membrane via the ABC transporter and converted to sulfite by an alkylsulfatase (Figure 5).

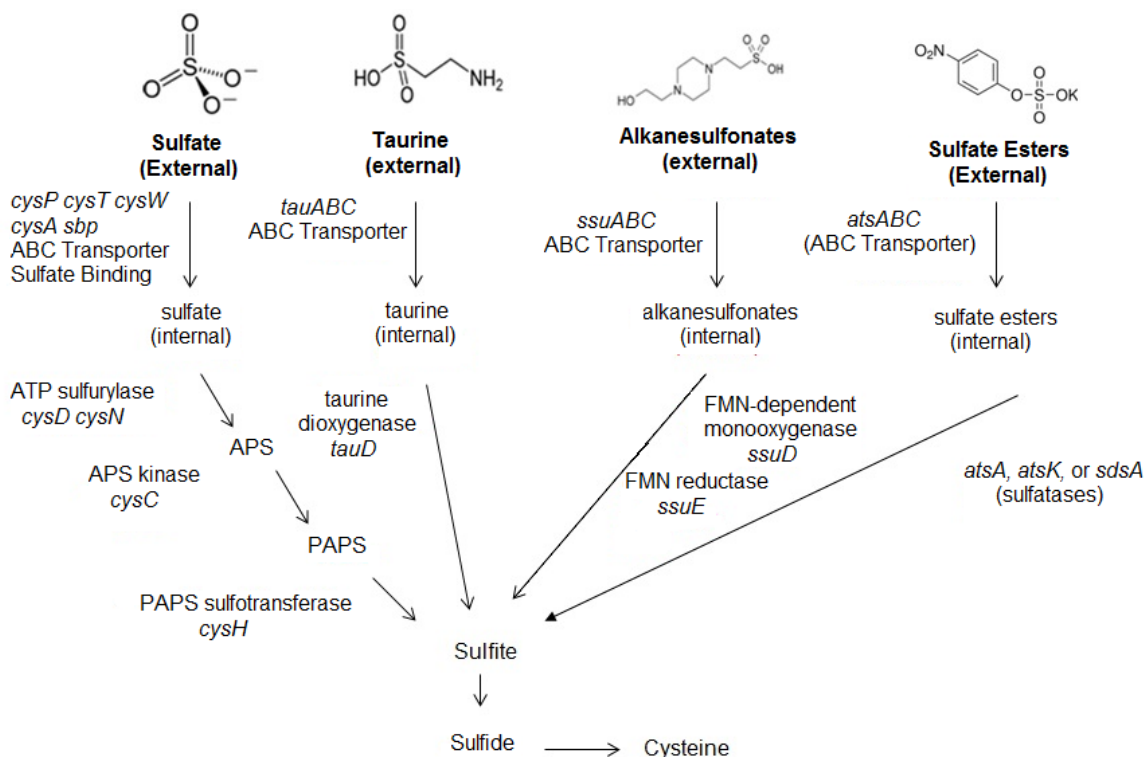

**Figure 5. Sulfur Acquisition and Utilization Pathways**

Sulfur can be utilized in an organic or inorganic form through the pathways shown above. Sulfate is utilized through the cysteine biosynthetic pathway encoded by the *cys* genes. Alkanesulfonates are utilized through the sulfonate utilization pathway that is encoded by the *ssu* genes. Taurine is a specialized alkanesulfonate because it can be utilized as a sulfur or nitrogen source; it has a separate acquisition and utilization pathway in some organisms. Taurine is utilized by the taurine utilization pathway encoded by *tau* genes. Finally sulfate esters are converted into sulfite by sulfatases encoded by the *ats* genes.

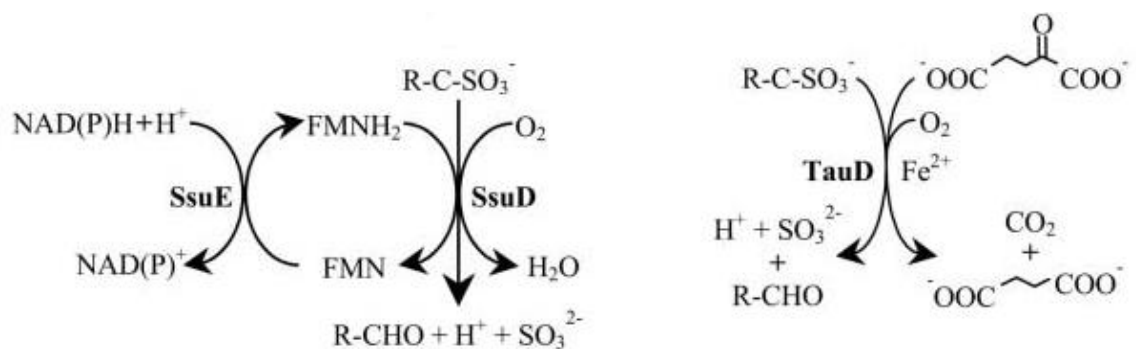

**Figure 6. Model of Sulfonate and Taurine Utilization**

The proteins encoded by *ssuD* and *tauD* function as monooxygenases for the breakdown of sulfonates. In addition to the monooxygenases, both the sulfonate and taurine utilization pathways have ABC transporters (van der Ploeg and Eichhorn, 2001).

## Sulfur Regulation

It has been demonstrated in *E. coli* that sulfur utilization genes is regulated by internal sulfur levels as measured by cysteine. Thus, cysteine production plays a key role in regulating sulfur utilization genes (van der Ploeg et al. 2001). Expression of the sulfate reduction pathway (cysteine biosynthetic pathway) is positively regulated by the protein CysB, and requires a coinducer *N*-acetylserine. *N*-acetylserine levels are controlled by internal levels of cysteine. When cysteine levels are low, high levels of *N*-acetylserine are produced and *cys* genes are induced. In addition to cysteine indirectly controlling the expression of *cys* genes, it also inhibits the production of Cbl which is a global regulator for alternative sulfur utilization (Figure 7). Sulfate has also been observed to play a role in inhibiting the expression of alternative sulfur utilization genes. Through analysis of different *cys* mutants it was determined that an intermediate in the sulfate reduction pathway is responsible for the inhibition of alternative sulfur source genes when cells are grown in the presence of sulfate (van der Ploeg et al. 2001).

.

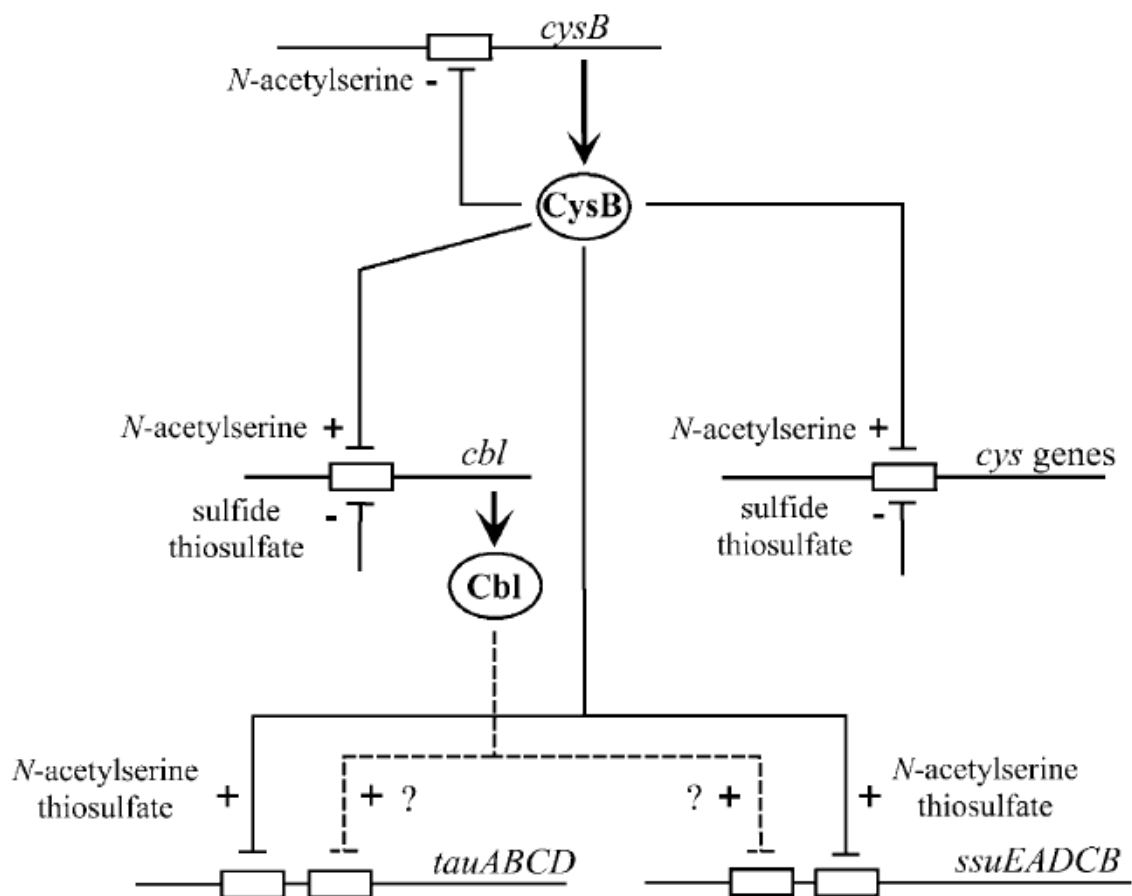

**Figure 7. Regulation of Alternative Sulfur Utilization Genes**

*N*-acetylserine, a precursor of cysteine, builds up when no sulfide is available for synthesis of cysteine. This compound acts to up-regulate alternate sulfur utilization genes such as the *tau* and *ssu* genes, and up-regulates global regulators *cbl* and *cysB* that also aid the regulation of alternative sulfur source utilization.

## Chapter II

### Determining the Role of Organic Sulfur Utilization in Rhizobia-Legume Symbiotic Nitrogen Fixation

#### Introduction

Rhizobia and legumes have evolved a symbiotic relationship for the effective acquisition of nitrogen, which is a major growth limiting factor in plants. Forage-legume nodulating rhizobia are amongst the most utilized root nodulating rhizobia in the agricultural world. An excess of 400 million hectares of agricultural land are dependent on nitrogen, derived from forage legumes such as clover (*trifolium* spp.), alfalfa (*Medicago*), and barrel medic (*M. truncatula*) (Herridge et al. 2008). A majority of these forage-legume dependent agricultural lands are in under-developed countries lacking the infrastructure for nitrogen fertilizer production. In addition to nitrogen derived from forage legumes, there are many agriculturally important legumes that contribute to nitrogen inputs such as soybean (*Glycine max*), common bean (*Phaseolus vulgaris*), and pea (*Pisum sativum*).

Symbiosis between rhizobia and legumes has been studied extensively over the past several decades as a possible source of sustainable nitrogen. Transcriptomic analysis of the symbiotic relationship between rhizobia and legumes has provided important details about the host-microbe interaction. Nodule formation, on legumes, has been shown to involve global changes in gene expression in both the plant and rhizobia (Kouchi et al.

2004; Mesa et al. 2008; Karunakaran et al. 2009; Delmotte et al. 2010; Schmutz et al. 2010). This process involves: growth in the rhizosphere, recognition and infection of roots, bacterial growth inside infection threads, and release of bacteria into symbiosomes in the cytoplasm of host cells. Once inside cortical plant cells, rhizobia differentiates into nitrogen-fixing bacteroids (Verma, 1992; Spaink, 2000; Broughon et al. 2000; Long, 2001).

Differentiating into nitrogen-fixing bacteroids involves the production of high levels of nitrogenase, which requires large amounts of sulfur to produce. There are 75 sulfur-containing amino acids in the nitrogenase complex. The two main components of nitrogenase, Fe protein and MoFe protein, are rich in sulfur. The Fe protein contains a 4Fe-4S cluster and is ligated in place by four cysteine residues. The MoFe protein contains two sulfur-rich metalloclusters, the 8Fe-7S containing P-cluster and the MoFe cofactor (7Fe-Mo-9S-homocitrate-X) (Seefeldt et al. 2009). Inside nitrogen-fixing nodules, nitrogenases are one of the most abundant proteins, and thus, put a high demand on sulfur acquisition for efficient nitrogen fixation (Figure 3).

In addition to the sulfur required for nitrogenase production, rhizobia also have a need for glutathione (a tripeptide containing cysteine) for protection from reactive oxygen species produced by the plant defense system during infection and nodulation. The impaired nitrogen fixation seen in *Sinorhizobium meliloti* glutathione mutants inoculated with *Medicago sativa* demonstrates the importance of glutathione in effective nitrogen-fixing symbiosis (Harrison et al. 2005).

In this study of organic sulfur utilization in rhizobia-legume symbiotic nitrogen fixation, two model organisms were used: *Bradyrhizobium japonicum* USDA110 and

*Sinorhizobium meliloti* RM1021. These organisms were chosen for several reasons. The first reason is the extensive amount of research that has been done on their ability to form effective nitrogen fixing symbiosis with legumes (Gyaneshwar *et al.* 2011; Jones *et al.* 2007). Additionally, both organisms have sequenced genomes. And finally, they were selected due to differences in the types of nodules they form with their host legumes. As stated earlier, there are two types of symbiotic nodules: determinate and indeterminate. *B. japonicum* colonizes determinate nodules while *S. meliloti* colonizes indeterminate nodules (Hirsch, 1992; Denison, 2000).

### *Bradyrhizobium japonicum* USDA110

*Bradyrhizobium japonicum* USDA110, a diazotroph, forms a symbiotic relationship with *Glycine max* (soybean). *Bradyrhizobium japonicum* was recently renamed to *B. diazoefficiens* USDA110. However, for this thesis, it will be referred to as *B. japonicum*. *B. japonicum* belongs to a group of plant-nodulating alphaproteobacteria called rhizobia (Graham, 2008; Gyaneshwar *et al.* 2011). *B. japonicum* induces and colonizes determinate nodules on soybean. Invaded plant cells begin dividing until the nodule is fully formed, after which cellular division is arrested. Increases in size after nodule formation are due to the enlargement of bacterial cells during differentiation into bacteroids, and increases in plant cellular volume (Hirsch, 1992).

While much is understood about how *B. japonicum* colonizes soybean and fixes nitrogen, very little is known about the role of sulfur during symbiosis. Upwards of 95% of the sulfur found in soil is in the form of sulfonates or sulfate esters. Thus, it is not surprising that *B. japonicum* has evolved the ability to utilize and grow on sulfonates and

sulfate esters as a sole sulfur sources (Sugawara et al. 2010). Likewise, *E. coli* can utilize sulfonates under sulfate limiting conditions by expressing a set of genes called sulfur starvation-induced genes (Kertesz, 1999). These genes allow for the utilization of alternate sulfur sources. In *E. coli*, sulfonate sulfur is utilized by two sets of genes, the sulfonate-sulfur utilization genes (*ssu*) and the taurine utilization (*tau*) genes (Kertesz, 1999). The *ssu* genes produce an ABC transporter (*ssuABC*), a NAD(P)H dependent FMN reductase (*ssuE*), and a FMNH<sub>2</sub>-dependent monooxygenases (*ssuD*) for breakdown of sulfonates to a sulfite and an aldehyde (Figure 8) (Kertesz, 1999). During a transcriptomic analysis, *B. japonicum* grown on alternate sulfur sources had increases in the expression of genes homologues to the *ssu* genes found in *E.coli* (Sugawara et al. 2010).

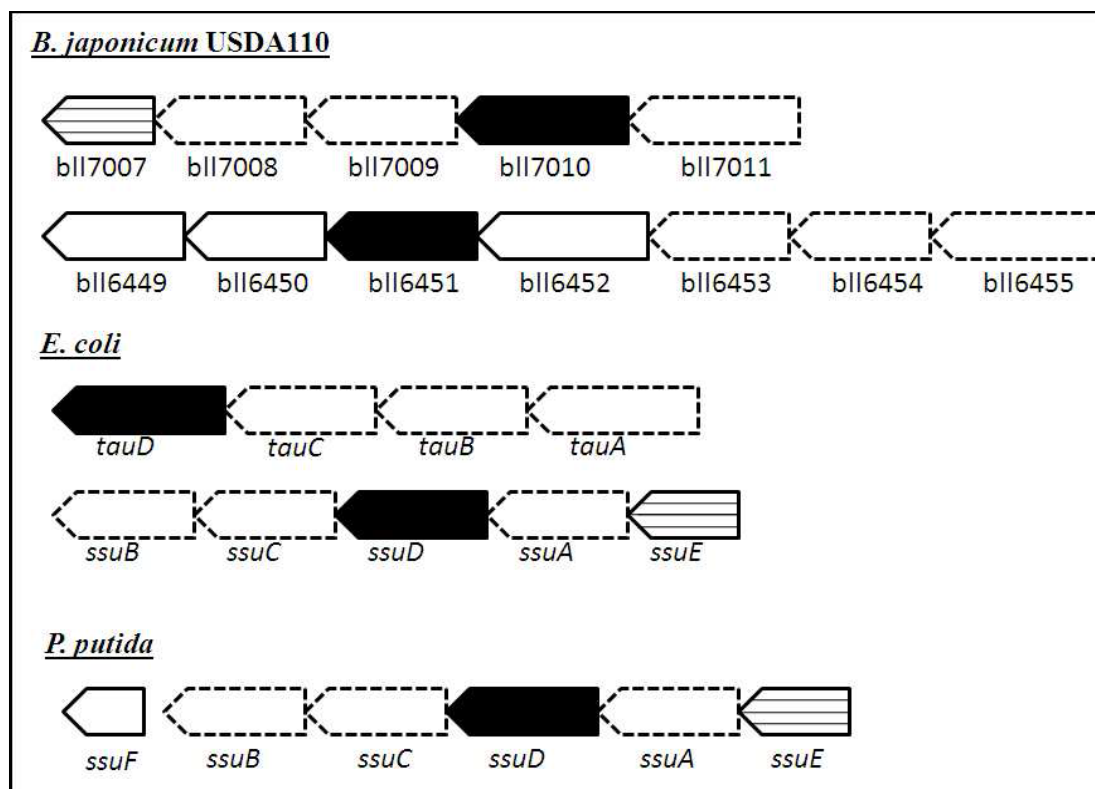

**Figure 8. Homologies between the *ssuD* Genes of *B. japonicum* and *E. coli***

Genes homologous to sulfonate utilization genes from *E. coli* that were identified in *B. japonicum* USDA110 (Sugawara et al. 2010).

Previous studies have shown a significant change in the expression of sulfur acquisition genes between free living and symbiotic conditions through transcriptomic analysis. More specifically, genes encoding sulfonate monooxygenases and sulfatases showed higher expression in symbiotic *B. japonicum* (Pessi et al. 2007; Mesa et al. 2008; Delmonte et al. 2010; Yan et al. 2013). Due to the large sulfur demand of *B. japonicum* during differentiation in nodules, low availability of sulfate, and increases in the expression of sulfonate and sulfatase genes, it was hypothesized that organic sulfur utilization would be vital for effective symbiosis and nitrogen fixation.

## *Sinorhizobium meliloti* RM1021

The legume nodulating rhizobia, *Sinorhizobium meliloti* RM1021 fixes nitrogen when in a symbiotic relationship with alfalfa (*Medicago*), fenugreek (*Trigonella*), sweetclover (*Melilotus*), and other legumes. The establishment of symbiosis involves a complex exchange of signals between the host plant and rhizobia. Successful exchange of signals, such as flavonoids and Nod factors, results in the formation of symbiotic nitrogen-fixing nodules, where rhizobia provide fixed nitrogen to the plant in exchange for plant synthates. To form this symbiotic relationship, the plant and rhizobia go through extensive physiological alterations involving global changes to gene expression (Fisher and Long, 1992).

This study used the *S. meliloti*-alfalfa (*Medicago sativa*) model system. Symbiosis between *S. meliloti* and alfalfa results in the formation of indeterminate nodules. The continual growth of the nodule meristem leads to elongated nodules. Indeterminate nodules can be divided into four distinct zones, as shown in Figure 9. The apical meristem (Zone I) consists of actively dividing plant cells that give the nodule its elongated look. The continual division of plant cells in this zone necessitates continual infection of new cells by the rhizobia. Infection of these newly formed cells occurs below Zone I in what is termed the infection zone (Zone II). In the infection zone rhizobia are continually infecting the newly formed cells and entering symbiosomes. The zone between the infection zone (Zone II) and the nitrogen-fixation zone (Zone III) is termed the interzone, where plants begin filling colonized cells with leghemoglobin, while the rhizobia elongate and differentiate into bacteroids for nitrogen fixation.

In the nitrogen-fixation zone (Zone III) a large portion of plant cells are filled with differentiated bacteroids actively fixing nitrogen (Figure 9) (Van de Velde et al. 2006). Below the nitrogen fixation zone is the senescent zone (Zone IV), where nitrogen fixation ceases and plant cells, bacteroids, and leghemoglobin are degraded. Degradation of the leghemoglobin results in the green color seen in this zone (Figure 9) (Van de Velde et al. 2006).

In the indeterminate nodule system rhizobia terminally differentiate into bacteroids. This dynamic system necessitates a pool of rhizobia ready to infect newly formed cells, as terminally differentiated bacteroids are eventually degraded in the senescent zone. This degradation of rhizobia stands in stark contrast to determinate nodules, where bacteroids are able to de-differentiate upon release from the nodules (Mergaert et al. 2006)

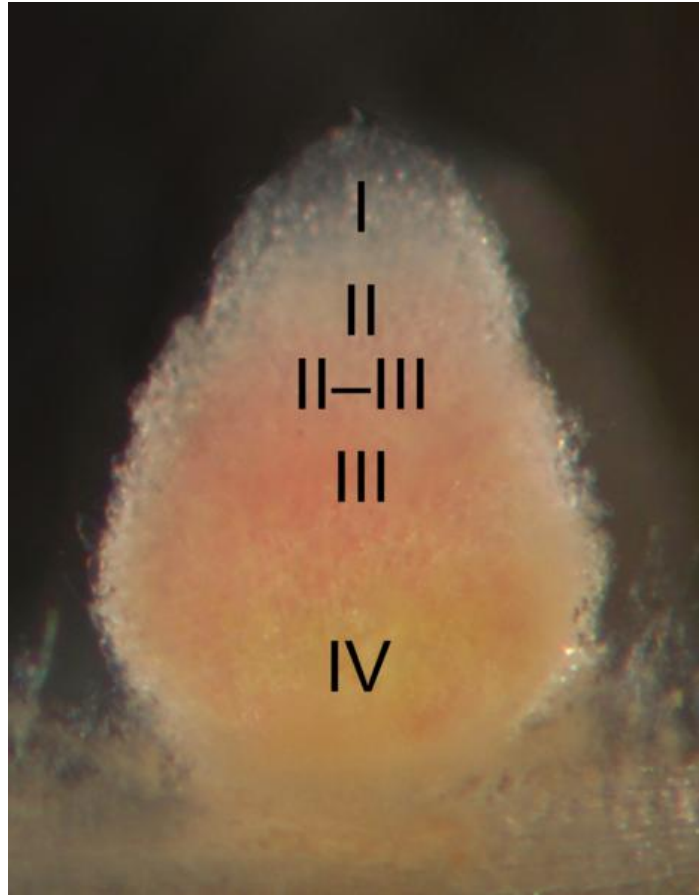

**Figure 9. Internal Structure of Indeterminate Nodules**

Indeterminate nodules have an apical meristem (I), an infection zone (II), an invasion zone (IIA), a pre-fixing zone (IIB), an intermediate zone (II–III), a nitrogen fixation zone (III), which consists of efficient nitrogen fixation (IIIA) and inefficient nitrogen fixation (IIIB) zones, and a senescent zone (IV).

Since the sequencing of *S. meliloti*, significant work has been done to determine the functional role and expression of a multitude of gene for which there was no functional information. To this end, a transcription fusion reporter was constructed to measure gene expression (Cowie et al. 2006). This reporter was used with the randomly digested genome to create a wide array of gene fusions (Figure 10). This gene fusion library provided an opportunity to examine the expression of sulfur utilization genes, for which nothing was known in *S. meliloti*.

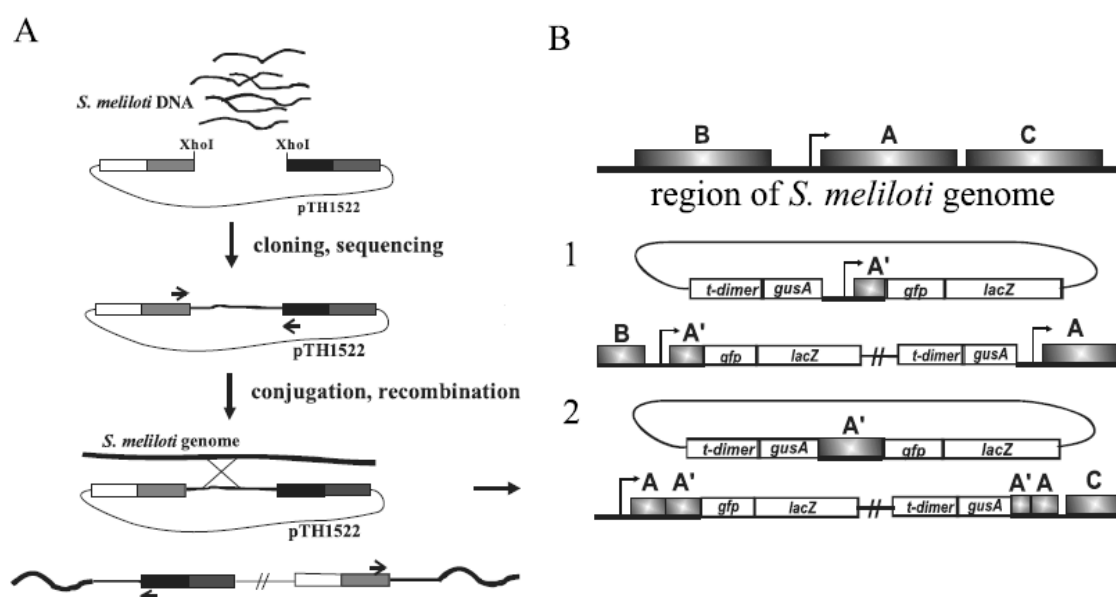

**Figure 10. Fusion Reporter Strain Construction**

The fusion strains were constructed using randomly digested genomic DNA and performing a single crossover into the genome. Expression of *gfp/lacZ* or *rfp/gusA* was observed based on the direction of the gene and orientation of the insertion (Cowie et al. 2006).

Traditionally, sulfate is used as a sulfur source in lab conditions, but sulfur available in agricultural settings is predominantly in the form of organic sulfonates and sulfate esters. This area of study has been widely ignored due to the readily available supply of inorganic sulfur left in soils from the coal burning during the industrial revolution. However, sulfur from air pollution is dwindling, leading to sulfur limitations in soil. Thus, it is important to understand what types of sulfur are important for both agriculturally important crops and the microbes that associate with them. Due to a majority of sulfur being in an organic form, it is hypothesized that the main source of sulfur during symbiosis is organic. In addition to understanding the role of sulfur for microbes in free-living conditions, a better understanding of sulfur requirements during symbiosis is needed. A better understanding of sulfur utilization for effective symbiosis and nitrogen fixation will aid in increasing the amount of biological nitrogen fixation and decrease our reliance on nitrogen fertilizers.

## Methods and Materials

### *Strains, Plasmids Primers, and Growth Conditions*

The strains, plasmids and DNA primers used in this study are listed in Table 1.

*B. japonicum* was grown at 30°C and 200 rpm in yeast manitol (YM) or modified L-arabnose-gluconate (AG) medium. YM medium contains the following (per liter): 10g manitol, 0.5g K<sub>2</sub>HPO<sub>4</sub>, 0.2 MgSO<sub>4</sub>, 0.1g NaCl, and 0.5g yeast extract. The modified AG medium had L-arabinose replaced with mannitol and FeCl<sub>3</sub> replaced with ferric citrate (Sadowsky et al. 1987). *B. japonicum* was maintained on YM agar. For inoculation studies, *B. japonicum* was grown in YM medium and washed with N<sup>-</sup>S<sup>-</sup>C<sup>-</sup> two times before plant inoculations. N<sup>-</sup>S<sup>-</sup>C<sup>-</sup> contains the following (per liter): 17.7g K<sub>2</sub>HPO<sub>4</sub>, 4.7g KH<sub>2</sub>PO<sub>4</sub>, 2.5g NaCl, and 0.1g MgCl<sub>2</sub>. Antibiotics used with *B. japonicum* were in the following concentrations: kanamycin 100µg/ml, tetracycline 70µg/ml, gentamicin 60µg/ml, and streptomycin 100µg/ml.

*E. coli* strains were grown at 37°C and maintained on LB agar. *E. coli* strains were washed with saline two to three times before mixing with rhizobia for conjugations. Antibiotics used with *E. coli* were in the following concentrations: kanamycin 50µg/ml, tetracycline 10µg/ml, gentamicin 20µg/ml, and ampicillin 100µg/ml.

*S. meliloti* was grown between 28°C and 30°C at 200 rpm in LBMC (Luria-Bertani broth containing 2.5mM MgCl<sub>2</sub> and 2.5mM CaCl<sub>2</sub>). For testing growth on different sulfur sources, N<sup>-</sup>S<sup>-</sup>C<sup>-</sup> was used as the sulfur free base medium. N<sup>-</sup>S<sup>-</sup>C<sup>-</sup> contains the following (per liter): 17.7g K<sub>2</sub>HPO<sub>4</sub>, 4.7g KH<sub>2</sub>PO<sub>4</sub>, 2.5g NaCl, and 0.1g MgCl<sub>2</sub>.

When inoculating strains for growth on sulfur sources, 10mM glucose, 5mM succinate, 10mM NH<sub>4</sub>Cl, 1mM MgCl, 5ng/mL biotin, 5ng/mL CoCl<sub>2</sub>, and 1mM of sulfur sources to be tested were added. Antibiotic concentrations used were as follows: 100μM streptomycin, 50μM kanamycin, 10μM tetracycline, and 100μM ampicillin.

*Table 1: Strains, Plasmids, and Primers Used in this Study*

<b>Strains</b>	<b>Description</b>	<b>Reference</b>
<i>Bradyrhizobium japonicum</i> USDA 110	Wild Type strain of <i>Bradyrhizobium diazoefficiens</i> Isolated from <i>Glycine hispida</i>	Lab Stock
<i>B. japonicum</i> <i>AssuD::kan</i>	<i>Bradyrhizobium sp. japonicum ssuD</i> disruption mutant, Kan <sup>r</sup>	This Study
<i>B. japonicum</i> <i>Δ4740::kan</i>	<i>Bradyrhizobium sp. japonicum bll4740</i> disruption mutant, Kan <sup>r</sup>	This Study
<i>B. japonicum-ΔAssuD-GFP</i>	<i>Bradyrhizobium sp. japonicum ssuD</i> deletion mutant Kan <sup>r</sup> containing pHC60, Tet <sup>r</sup>	This Study
<i>B. japonicum-GFP</i>	Wild type <i>B. japonicum</i> containing pHC60, Tet <sup>r</sup>	This Study
<i>B. japonicum-Δblr7010::Himar</i>	<i>Bradyrhizobium sp. japonicum Δblr7010::Himar</i> mutant, Kan <sup>r</sup>	Sugawara et al. (2011)
<i>B. japonicum-Δbll4740::Himar</i>	<i>Bradyrhizobium sp. japonicum Δbll4740::Himar</i> mutant, Kan <sup>r</sup>	This Study
<i>E. coli</i> β2155	DAP dependent host strain for interspecies conjugation	Lab Stock
<i>E. coli</i> S17.1	Host strain for interspecies conjugation	Lab Stock

<b>Strains</b>	<b>Description</b>	<b>Reference</b>
<i>E. coli</i> DH5 $\alpha$	General cloning host	Lab Stock
<i>sbp-gusA-rfp</i>	<i>Sinorhizobium sp. meliloti gusA/rfp</i> reporter fusion with <i>sbp</i> , Gent <sup>r</sup>	Cowie et al. 2006
<i>tau-gusA-rfp</i>	<i>Sinorhizobium sp. meliloti gusA/rfp</i> reporter fusion with <i>tau</i> , Gent <sup>r</sup>	Cowie et al. 2006
$\Delta$ <i>ssuD::gfp-lacZ</i>	<i>Sinorhizobium sp. meliloti lacZ/gfp</i> reporter fusion with <i>ssuD</i> , Gent <sup>r</sup>	Cowie et al. 2006
<i>SM_b20568-gfp-lacZ</i>	<i>Sinorhizobium sp. meliloti lacZ/gfp</i> reporter fusion with <i>SM_b20568</i> , Gent <sup>r</sup>	Cowie et al. 2006
<i>Sinorhizobium meliloti RM1021</i>	Wild type strain of <i>Sinorhizobium meliloti</i>	Lab Stock
<b>Plasmids</b>	<b>Description</b>	<b>Reference</b>
pHC60	IncP Tetr, <i>gfp</i> under the control of a constitutive <i>lac</i> promoter	Cheng and Walker (1998)
pMiniHiMar	<i>mini-HimarRB1</i> transposon, R6K <i>ori</i>	Bouhenni <i>et al.</i> (2005)
pUC18	Amp <sup>r</sup> General cloning vector	Lab Stock
pGEM-T Easy	Amp <sup>r</sup> General cloning vector	Promaga
pSUP202 pol4	Tet <sup>r</sup> mob vector	Fischer et al. (1993)
pLAFR	Tet <sup>r</sup> Broad host range cosmid	Vanbleu et al. (2004)

<b>Primers</b>	<b>Sequence</b>	<b>Reference</b>
<i>7011 F</i>	AGCGTCGGGACTTTCTGAGACTTT	This Study
<i>7011 R</i>	TCAGAGCGCTTTTGAAGCTAATTCGGAT	This Study
Himar 1	CATTTAATACTAGCGACGCCATCT	This study
Himar 615	TCGGGTATCGCTCTTGAAGGG	This study
<i>Kan F</i>	CGACGGCCAGTGAATTGTAATACG	This study
<i>Kan R</i>	GCTATGACCATGATTACGCCAAGC	This study
<i>ssuD F</i>	CCTGATCCCCAAGCCGATCGTGA	This study
<i>ssuD R</i>	AGGGTCGCTAGTCGTTGCCGA	This study
<i>4741 F</i>	ATTCTTCTGGCGGACGCTTGTTAC	This study
<i>4740 R</i>	TTAACCTCAAGCGCGATCCATTCG	This study
$K_1$	CAGTCATAGCCGAATAGCCT	Datsenko and Wanner, 2000
$K_2$	CGGTGCCCTGAATGAACTGC	Datsenko and Wanner, 2000
$K_t$	CGGCCACAGTCGATGAATCC	Datsenko and Wanner, 2000

## *Construction of $\Delta ssuD$ Mutant*

To construct the *ssuD* mutant, *bll7010* was amplified using Phusion, blunt cloned into the *Sma*I site of pUC18, and transformed into DH5 $\alpha$ . Transformants were selected on LB containing 100 $\mu$ g/ml ampicillin and 50 $\mu$ g/ml X-gal for blue white screening. The gene *ssuD* was digested with *Eco*RV, and a kanamycin cassette, amplified with Phusion, was ligated into the *Eco*RV site. The vector was transformed into DH5 $\alpha$  and selected on 50 $\mu$ g/ml kanamycin. The disrupted *ssuD* gene was amplified with Phusion, cloned into the *Sma*I site of suicide vector pSUP202, transformed into DH5 $\alpha$ , and selected on 10 $\mu$ g/ml tetracycline; 50 $\mu$ g/ml kanamycin.  $\Delta ssuD::kan$  pSUP202 pol4 was transferred into the DAP dependent  $\beta$ 2155 *E.coli* strain.  $\Delta ssuD::kan$  pSUP202 pol4 was conjugated into *B. japonicum* and selected on 100 $\mu$ g/ml kanamycin. Double crossover was confirmed by PCR amplification.

## *Sulfur Source Utilization Experiments*

Bradyrhizobium strains were grown in AG medium at 30°C to stationary phase. Cells were collected by centrifugation at 10,000  $\times$  g for 15 min, washed twice in sulfur-free N<sup>+</sup>S<sup>-</sup>C<sup>-</sup>, resuspended in 100 ml of the same medium supplemented with 10mM glucose, 10mM NH<sub>4</sub>Cl and 1mM MgCl. Cells were then incubated at 30°C for four days to induce sulfur starvation. Cell suspensions were streaked onto N<sup>+</sup>S<sup>-</sup>C<sup>-</sup> plates supplemented with 10mM glucose, 10mM ammonium chloride, 1mM MgCl<sub>4</sub> and 2mM of appropriate sulfur sources (including sulfate, sulfonate HEPES, taurine, and di-

benzothiophene) for testing the growth of *B. japonicum*. Plates were incubated at 30°C for seven days.

### *Rhizobial Colonization of Host Plants*

Seeds were germinated as follows. Seeds were sterilized with ethanol for five minutes, washed with sterile deionized water five to six times. Rhizobial cultures were grown in YM or LBMC to an OD<sub>600</sub> of 0.6. Cells were harvested by spinning at 10,000 rpm for 15 minutes and washed twice with saline. Cultures were then inoculated onto germinated seedlings for five minutes before planting in vermiculite. Plants were grown in vermiculite with nitrogen free plant growth medium and watered with nitrogen free medium as needed (Jensen et al. 1985).

### *Quantitative Plating of Viable Colonized Rhizobia*

Nodules were taken three to five weeks after inoculation with appropriate strain of *B. japonicum*. Nodules were picked off plant roots and weighed. Approximately 0.1 grams of nodule were used. Nodules were washed with 95% ethanol for five minutes before rinsing thoroughly with sterile deionized water. Nodules were then suspended in 500 µL of N<sup>-</sup>S<sup>-</sup>C<sup>-</sup> medium and crushed, using a wood applicator stick in a 1.5 mL Eppendorf tube. Tubes were then spun at 5000 rpm in a desktop centrifuge for five minutes to remove cell debris. Dilutions were then made by diluting 10 µL of supernatant into 990 µL of sterile N<sup>-</sup>S<sup>-</sup>C<sup>-</sup> to make a 10<sup>-2</sup> solution. The same dilution was carried out again, but using 10 µL of the 10<sup>-2</sup> dilution instead of the original supernatant

to make a  $10^{-4}$  dilution. From that point on, dilutions of ten to one were made to create dilutions  $10^{-5}$ ,  $10^{-6}$ ,  $10^{-7}$ , and  $10^{-8}$ . Plates with and without the appropriate antibiotics were divided, and 10  $\mu$ L of the appropriate dilution was plated into each section. Plates were incubated at 30<sup>0</sup>C for two to three days before counting colonies under a dissecting microscope.

### *Chlorophyll Content and Dry Weight of Bradyrhizobium japonicum colonization Experiments*

Chlorophyll assays were performed on plants four to five weeks after inoculation. Tests were conducted on the newest fully formed leaves. leaf material (0.05g) was cut into small pieces and incubated with 1mL of 80% acetone in a 2 ml test tube until leaves were blanched 12-24hr (Huang et al. 2004). Samples were then analyzed using a spectrophotometer at wave lengths 663nm and 645nm in a 96 well plate. Calculations for determination of chlorophyll a and b content were as follows:  $C_{a+b}$  (mg/g) =  $(8.02 * \text{Absorbance at 663nm} + 20.20 * \text{Absorbance at 645nm}) * \text{Volume (mL)} / 1000 * \text{weight(g)}$ .

Dry weights were taken four to five weeks after inoculation. Plants were harvested, and the roots were removed. The stem and leaves were wrapped in aluminum foil and dried in a dryer at 80<sup>0</sup>C until dry. After samples were completely dry, samples were then weighed for comparison.

### *Acetylene Reduction Assay (ARA)*

Acetylene reduction, a proxy for nitrogenase activity, was assayed on plants four to five weeks post inoculation. Roots were excised and placed in sterile-capped 30ml glass test tube. 10ml of air was replaced with acetylene. Reduction was allowed to occur overnight 16 to 18 hrs before samples were tested. The conversion of acetylene to ethylene was measured by gas chromatography, using an Agilent 6850 gas chromatograph. The percentage of ethylene to acetylene was quantified and compared across samples to determine fixation ability. Appropriate controls were made to check for spontaneous ethylene production (Penmetsa et al. 2003).

### *Confocal Imaging of Host Plant Colonization*

Plant colonization was observed through confocal microscopy by making the wild type *B. japonicum* and *AssuD::kan* mutant with GFP. *B. japonicum* strains were conjugated with *B2155 E. coli*, carrying the GFP plasmid pHC60, and selected on YM plates with 70 $\mu$ g/ml tetracycline (Cheng and Walker 1998). pHC60 is a broad host range plasmid with constitutive GFP expression under the control of a constitutive *lac* promoter (Cheng and Walker 1998).

Plants were germinated and inoculated with GFP marked strains as described earlier. The host plants were examined at one week intervals after inoculation under a confocal microscope. Roots were stained with 100 ng/mL propidium iodide for approximately 5 min before observing. Free-hand sectioning was done on stained roots, and three-dimensional (3D) laser scanning confocal microscopy was performed with a

TCS SP2 (Leica Microsystems, Bannockburn, IL), using a wavelength of 488 nm for excitation of both GFP and propidium iodide. The fluorescence of GFP and propidium iodide were observed in two specific emission windows of 500-550 nm (GFP) and 640-700 nm (propidium iodide) (Marcel *et al.* 2010).

### *Histochemical Staining for Sulfatase Activity*

To observe sulfatase activity in *B. japonicum*, minimal media plates containing 2mM 5-bromo-4-chloro-3-indolyl sulfate potassium salt (x-sulfate) (from biosynth) as a sulfur source and sulfatase activity indicator were used (Kahnert *et al.* 2002).

*B. japonicum* was streaked onto plates and incubated for three to four days under microaerobic conditions.

Staining of nodules was done in one of two ways as follows: Nodules were sectioned using a sterile razor blade and incubated in 0.1 M phosphate buffer, pH 7.0, containing X-sulfate at 50µg/mL (Sugawara *et al.* 2011). For the second method, nodules were left intact, incubated in Z buffer with 50µg/mL in a vacuum for five minutes to drive the X-sulfate into nodules. When nodules were removed from vacuum, they were incubated for additional 3-4 hours before rinsing, sectioning with sterile razor, and examining.

### *$\beta$ -Galactosidase Assay*

Cells were grown to an  $OD_{600}$  of  $\approx 0.6$  and resuspended in Z buffer to an  $OD_{600}$  of 0.3-0.4. A volume of 800 $\mu$ L of the  $OD_{600}$  0.3-0.4 cells were used. 50 $\mu$ L of 0.1% SDS and 100 $\mu$ L of chloroform were added to lyse the cells. Lysed cells were equilibrated to 30°C in a water bath for 15 min. 160 $\mu$ L of 4mg/mL ONPG was added, and samples were incubated at 30°C until yellow color was observed. The reaction was quenched by adding 400 $\mu$ L of 1N sodium carbonate. Samples were centrifuged to remove cell debris, and measurements were taken of the supernatant in 96 well plates at 420 nm and 550 nm. Activity was calculated as Miller units (Miller, 1972).

### *Gene Induction Experiments*

Cultures were grown in LBMC to mid log phase before inoculating into N<sup>-</sup>S<sup>-</sup>C<sup>-</sup>, with nitrogen, carbon, and 1mM of the sulfur source being tested. Cultures were induced on the sulfur source overnight.  $OD_{600}$  readings of the cultures were taken before spinning down and resuspending in fresh N<sup>-</sup>S<sup>-</sup>C<sup>-</sup> to an  $OD_{600}$  of 0.3. 200 $\mu$ L of each sample was read in a 96 well, clear bottom, black plate with an excitation of 395nm and emission reading at 509nm. Induction was expressed as GFP signal per absorbance at  $OD_{600}$ .

## *H<sub>2</sub>O<sub>2</sub> Growth Experiments*

Rhizobial cultures were grown to mid log phase in AG (*B. japonicum*) or LBMC (*S. meliloti*). 10µL of mid log phase cultures were then inoculated into fresh media containing different concentrations of hydrogen peroxide (0µm, 5µm, 10µm, and 50µm). OD<sub>600</sub> readings were then taken to observe growth, and samples were taken for GFP/OD readings in a 96 well plate.

## Results

### *Bradyrhizobium japonicum Utilizes both Organic and Inorganic Sulfur as a Sole Sulfur Source.*

To determine the range of sulfur source utilization of *B. japonicum*, cultures of *B. japonicum* were tested for the ability to grow on different sulfur sources. Cultures were sulfur-starved before inoculating into minimal media with single sulfur sources, and end point OD<sub>600</sub> was taken to determine growth. *B. japonicum* was able to utilize a wide variety of sulfur sources, including: sulfate, a variety of sulfonates, sulfate esters, cysteine, methionine, and glutathione. The results demonstrate that *B. japonicum* was able to grow to higher densities on organic sulfur sources, such as sulfonates, than on inorganic sulfur (Figure 11).

To test the growth of *B. japonicum* on sulfonates further, growth curve analysis of *B. japonicum* on YM with sulfate as the primary sulfur source and AG, with HEPES (a sulfonate) as the major sulfur source, was performed. The growth curves demonstrated that *B. japonicum* grows faster and to a higher OD<sub>600</sub> on sulfonates than sulfate (Figure 12). The ability to utilize organic sulfur is advantageous to *B. japonicum* in soil environments as well as in symbiosis where inorganic sulfur is likely to be limited.

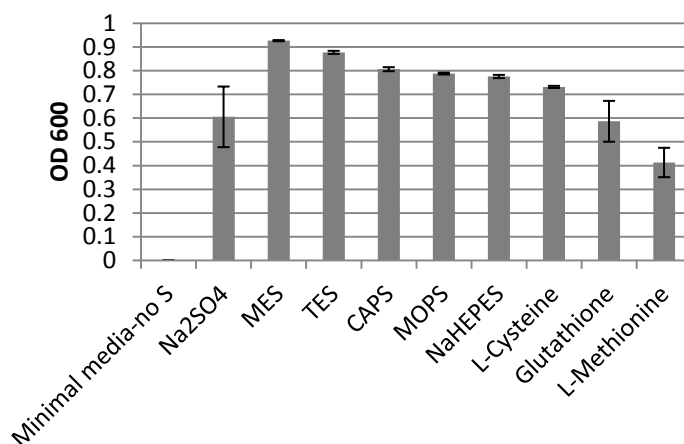

**Figure 11. Growth of *Bradyrhizobium japonicum* on Different Sulfur Sources**

*B. japonicum* was sulfur starved and then grown in N<sup>-</sup>S<sup>-</sup>C<sup>-</sup> supplemented with NH<sub>4</sub>Cl, glucose, and different sulfur sources (1mM). Higher OD<sub>600</sub> was reached on sulfonates than on sulfate. *B. japonicum* was also able to grow well on sulfur containing amino acids and glutathione as sole sulfur sources.

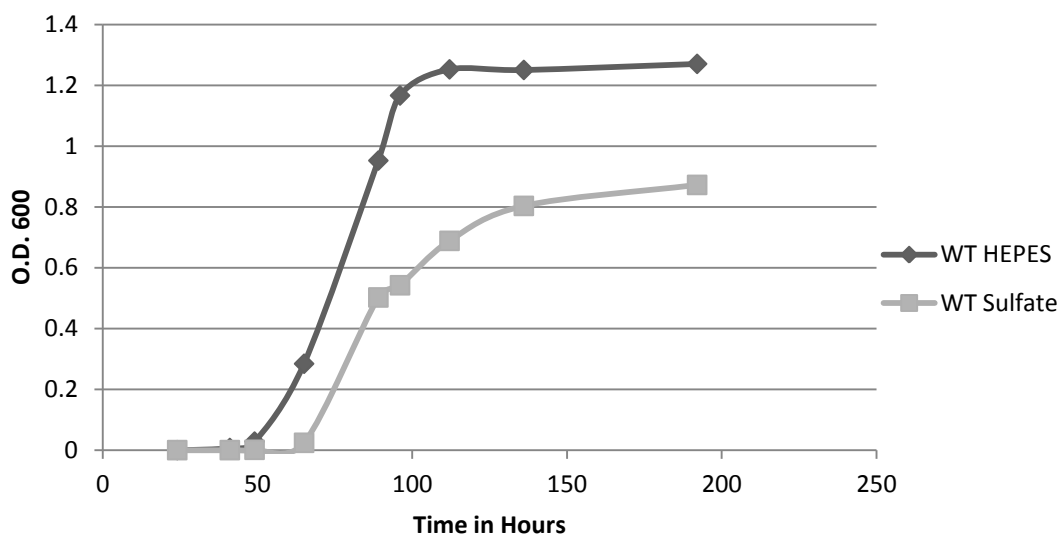

**Figure 12. Growth Curve of *B. japonicum* on Sulfate and HEPES as Sole Sulfur Sources**

Cells OD<sub>600</sub> readings were taken twice a day. Cultures were able to grow better when sulfonates were present to be utilized.

## *The Gene ssuD is required for Utilization of Sulfonates in*

### *B. japonicum*

Through the comparative analysis of *E.coli* sulfonate genes with *B. japonicum*, *bll7010* was identified as a putative sulfonate sulfur utilization gene (*ssu*). Additionally, qRT-PCR of *bll7010* (*ssuD*) in *B. japonicum* showed an increase in the expression of this putative sulfonate gene on sulfonates and in bacteroids. In order to explore the hypothesis that sulfonate utilization is important for effective symbiosis in *B. japonicum*, an *ssuD* insertional mutant was constructed and confirmed using PCR. As seen below in figure 13, wild type *B. japonicum* was able to grow on the sulfonate HEPES, whereas the sulfonate mutant ( $\Delta ssuD::kan$ ) was defective in growing on HEPES minimal media. This confirmed the role of *ssuD* in the utilization of sulfonate sulfur (Figure 13).

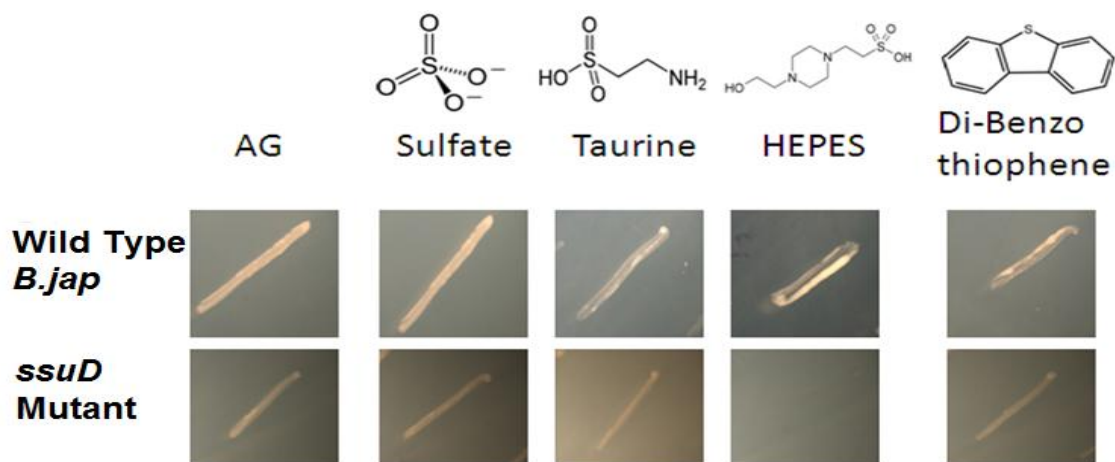

**Figure 13. Growth of Wild Type and the  $\Delta ssuD::kan$  Mutant on Different Sulfur Source**

Wild type and  $\Delta ssuD::kan$  mutant cultures were patched onto minimal media plates containing 1 mM concentrations of appropriate sulfur source. Cultures were also plated on AG, a rich medium, as a control.

## *Soybean Inoculated with *B. japonicum* $\Delta$ ssuD::*kan* has a Nitrogen Deficient Phenotype*

Inoculating *B. japonicum* on germinated soybean (*Glycine max* L.) induces the formation of symbiotic nodules, as described previously. The nodules harbor differentiated *B. japonicum* that fix nitrogen for the plant in exchange for photosynthates and other nutrients (Udvardi and Poole, 2013). When nitrogen fixation does not occur, plants show the symptoms of nitrogen deficiency. These symptoms can be observed as chlorosis (yellowing) of leaves, as nitrogen limitation results in reduced chlorophyll content and stunted growth. A strong correlation between available nitrogen and chlorophyll content has been established, allowing for the diagnosis of nitrogen deficiency through both a visual assessment of leaves and chlorophyll assays (Bojović et.al, 2009). Additionally, due to the stunted growth of nitrogen deficient plants, dry weights may be used to assess nitrogen limitation.

Plants inoculated with the  $\Delta$ ssuD::*kan* strain of *B. japonicum* displayed signs of nitrogen limitation when grown in nitrogen free media. This nitrogen limitation was observed through both stunted growth and chlorosis of leaves when compared with the wild type plants (Figures 14 and 15). A nitrogen limitation suggests that sulfonate sulfur utilization is required for nitrogen-fixing symbiosis.

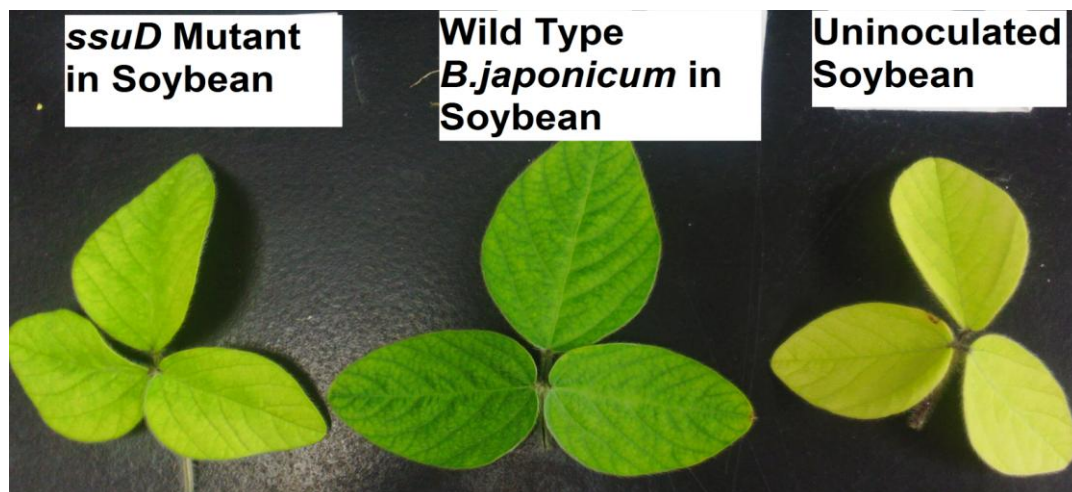

**Figure 14. Leaflets from Wild Type,  $\Delta ssuD::kan$ , and Uninoculated Soybean**

Plants were grown on nitrogen free media and harvested four to five weeks after inoculation. A nitrogen deficiency was observed in the uninoculated plant leaflet, as well as in the  $\Delta ssuD::kan$ -inoculated plant leaflet.

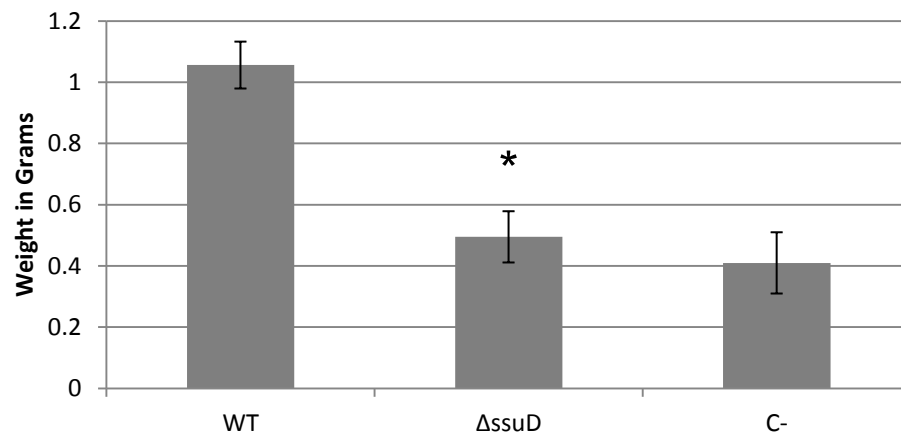

**Figure 15. Soybean (*Glycine max*) Inoculated with Wild Type *B. japonicum* (Left side) and  $\Delta ssuD::kan$  Mutant *B. japonicum* (right side)**

Plants were grown on nitrogen free media and harvested four to five weeks after inoculation. Wild type plants were healthy, growing large and having dark green leaves. The  $\Delta ssuD::kan$ -inoculated plants were smaller, and the leaves were yellowing, indicating reduced chlorophyll and thus, suggesting a nitrogen deficiency.

Further confirmation of nitrogen deficiency was done by assessing the dry weights. Once again, plants were grown in nitrogen free media and inoculated with different strains of *B. japonicum*. Nitrogen was the growth limiting factor, and any defect in nitrogen fixation would be observed in the stunted growth of plants. The results (Figure 16) show that the *AssuD::kan*-inoculated plants had half the dry mass of the wild type-inoculated plants, which is consistent with a lack of nitrogen in the *AssuD::kan*-inoculated plants. These results suggest that nitrogen fixation is not occurring in the *AssuD::kan*-inoculated plants.

In addition to dry weights, the nitrogen levels were indirectly measured by the amount of chlorophyll present in the plant leaves. The chlorophyll content was measured in milligrams of chlorophyll A and B per gram of leave tissue. As seen in Figure 17, the chlorophyll content of the *AssuD::kan*-inoculated plants was approximately half the chlorophyll content of the wild type-inoculated plants. This result was consistent with the difference seen in the dry weight of the *AssuD::kan*-inoculated plants compared to the wild type. Once again, these results were consistent with the idea that the *AssuD::kan* mutant is not fixing nitrogen with its host plant, soybean.



**Figure 16. Dry Weights of Wild Type and  $\Delta ssuD::kan$ -inoculated Plants**

Dry weights of the stem and leaves were taken four to five weeks after inoculation. Plants were grown in nitrogen free medium. The  $\Delta ssuD::kan$  mutant was similar in weight to the uninoculated control plant and half of the wild type-inoculated plant.

\*Significance of  $\Delta ssuD::kan$  compared with wild type (P-value =0.011).

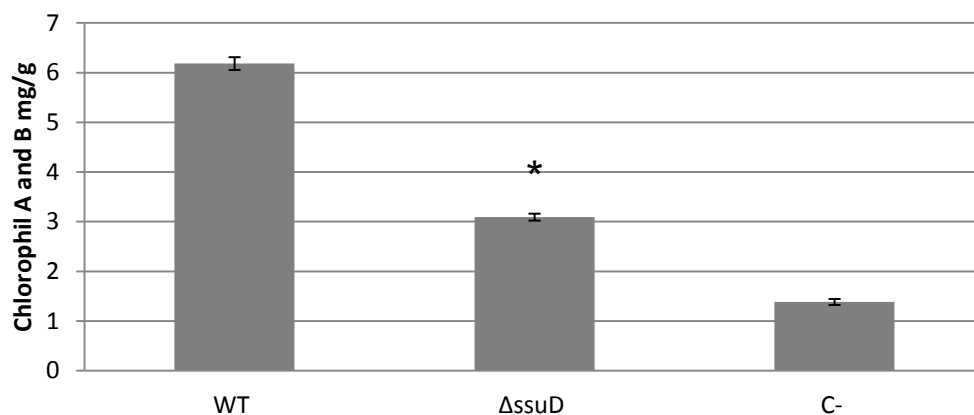

**Figure 17. The Chlorophyll Content of Soybean Leaves**

50mg-100mg of leaf, taken four to five weeks after inoculation, was snap frozen and crushed with dry ice. Chlorophyll was extracted with acetone. The  $\Delta ssuD::kan$  mutant showed reduced chlorophyll content compared to the wild type plant.

\*Significance of  $\Delta ssuD::kan$  comparison with wild type (P-value <0.001).

## *ΔssuD::kan*-inoculated Plants Display Morphological Differences in Root Nodules

Nitrogen fixation occurs in symbiotic organs called nodules. Any disruption in the formation of these nodules will interfere with nitrogen fixation. Thus, plant roots were examined for defects in nodule development as a possible cause for the nitrogen deficient phenotype seen in *ΔssuD::kan*-inoculated plants. Three criteria were used to evaluate the nodules: number of nodules formed, size and color of nodules, and production of leghemoglobin within nodules.

*ΔssuD::kan*-inoculated plants showed a slight decrease in the number of nodules present, as seen in Figure 18. Despite being statistically significant, the difference was relatively small. This suggests that the rhizobia are still able to detect flavonoids released by the plant and respond with Nod factors to induce nodule formation. It is likely that the defect is not due to plant-rhizobia signaling but during invasion, growth inside of the nodules, or construction of sulfur rich nitrogenases.

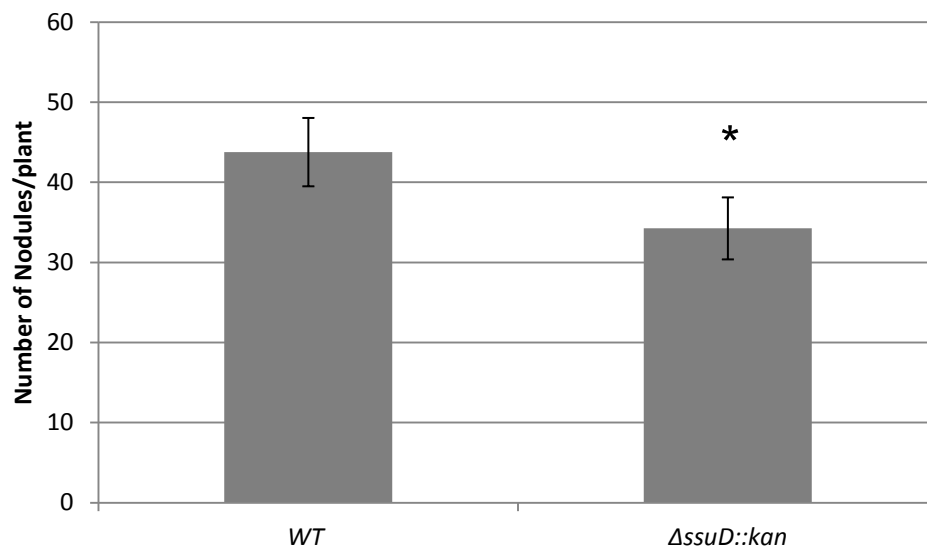

**Figure 18. Average Number of Nodules per Plant in Soybean Inoculated with Wild Type and  $\Delta ssuD::kan$  Mutant**

The nodule count was done on plants four to five weeks after inoculation. Only a small difference was seen between the numbers of nodule on the wild type versus mutant inoculated plant.

\*Significance of  $\Delta ssuD::kan$  comparison with wild type (P-value =0.007).

While examination of the soybean roots from wild type-inoculated plants and *AssuD::kan*-inoculated plants showed very little difference in the number of nodules present (Figures 18 and 19), there were pronounced morphological differences between the nodules. The morphological differences were seen in the dramatic size difference and color of nodules from *AssuD::kan*-inoculated plants when compared with nodules from wild type-inoculated plants. The *AssuD::kan*-inoculated plants displayed nodules that were small and white in color. Conversely, the wild type-inoculated plants had large nodules that were pink (Figures 19 and 20). To quantify the difference in nodule mass, weights were taken and the wild type-inoculated plants had nodules that had four times greater mass than the mutant inoculated plant nodules (Figure 21). This defect in the maturation of plant nodules, in *AssuD::kan*-inoculated plants, suggests that the rhizobia are either unable to infect the roots or unable to grow once inside cortical-nodule cells.

Plant nodules were examined further by sectioning nodules to examine the internal development. The sectioned nodules displayed a difference in the internal color of the nodules. The wild type-inoculated plants had nodules that were pink to red in color, indicating proper development of leghemoglobin, whereas the *AssuD::kan*-inoculated plants had nodules were white to slightly pink, indicating a problem in nodule development (Figure 22). Once again, the defect could be due to viability inside of nodules or an inability to invade root cells.



**Figure 19. Roots from Plants Inoculated with Wild Type and  $\Delta ssuD::kan$  Mutant *B. japonicum***

Plants were inoculated with either wild type *B. japonicum* or  $\Delta ssuD::kan$  *B. japonicum*. Plants were grown in nitrogen-free medium for three weeks. The  $\Delta ssuD::kan$ -inoculated plant (left) has nodules which look underdeveloped, as they appear to be small and white in color. The wild type-inoculated plant (right) has mature nodules that are large and pink in color, indicating the development of leghemoglobin.

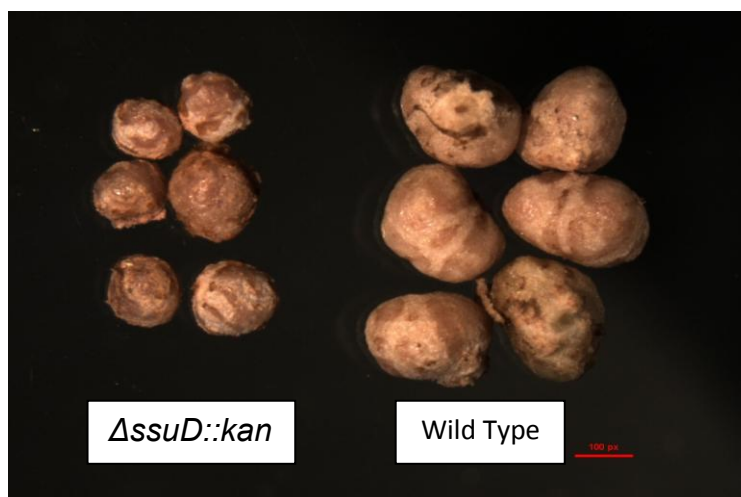

**Figure 20. Size Comparison of Wild Type and  $\Delta ssuD::kan$  Nodules**

The 20 largest nodules were picked off of the plant roots four to five weeks after inoculation, six of which are pictured here. Nodules from  $\Delta ssuD::kan$ -inoculated plants (left side) appear significantly smaller than the nodules of wild type-inoculated plants (right side).

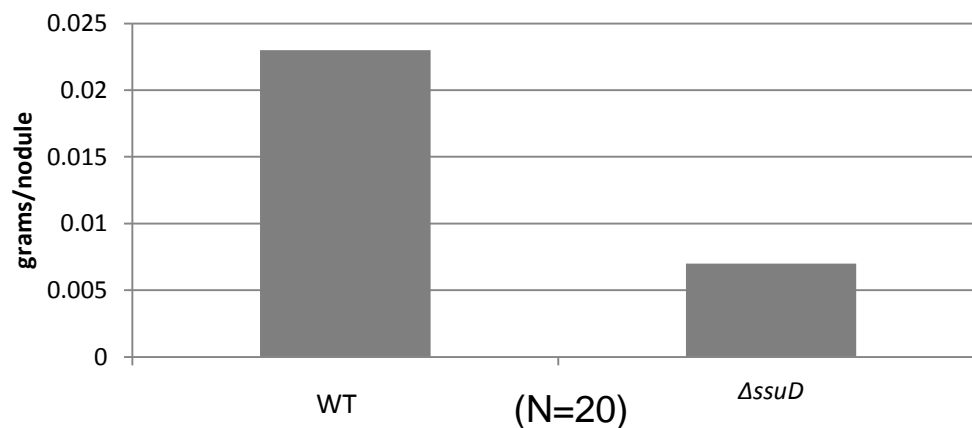

**Figure 21. Nodule Counts from Wild Type and  $\Delta ssuD::kan$ -inoculated Plants**

Twenty of the largest nodules were taken from each plant four to five weeks after inoculation. The nodules were then weighed together, and the average weight per nodule was determined by dividing the total weight by the total number of nodules (thus, there are no error bars). The wild type-inoculated plants were found to have nodules that weighted four times more than the  $\Delta ssuD::kan$ -inoculated plants.

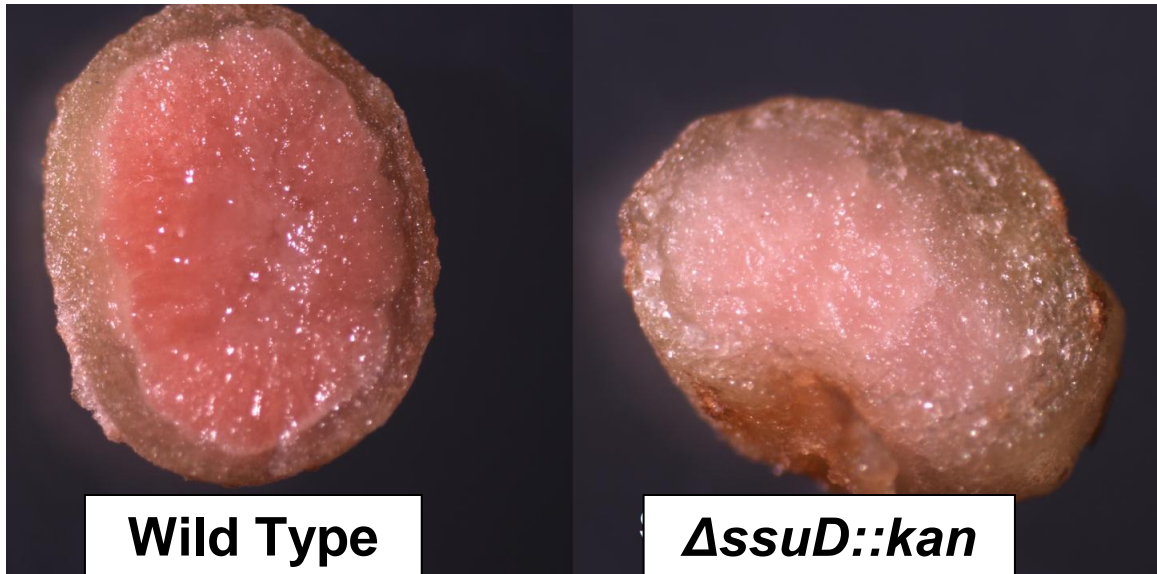

**Figure 22. Images of Wild Type and  $\Delta ssu D::kan$  Colonized Nodules**

Nodules were harvested four to five weeks after inoculation. After harvesting, nodules were sectioned for photographing. The wild type-inoculated plants have nodules that are pink to red inside, indicating the development of leghemoglobin (left). The  $\Delta ssu D::kan$ -inoculated plants have nodules that are white inside, indicating a defect in leghemoglobin production (right).

Acetylene-ethylene assays were done on the wild type and the  $\Delta ssuD::kan$  strain of *B. japonicum* to measure any nitrogen fixation occurring inside the nodules. This was done to test for the possibility of *B. japonicum*  $\Delta ssuD::kan$  fixing nitrogen but not passing it to the plant. The acetylene-ethylene assay results suggested a complete lack of fixation in the  $\Delta ssuD::kan$ -inoculated plants (Figure 23). Alternatively, the wild type-inoculated nodules showed about ten percent of the acetylene being converted to ethylene. This defect in  $\Delta ssuD::kan$ -inoculated plants could be due to an absence of rhizobia in nodules or a defect in the ability to differentiate into bacteroids and produce and protect nitrogenases. However, based on previous results, it is likely that the rhizobia are absent from the nodules due to the underdevelopment seen.

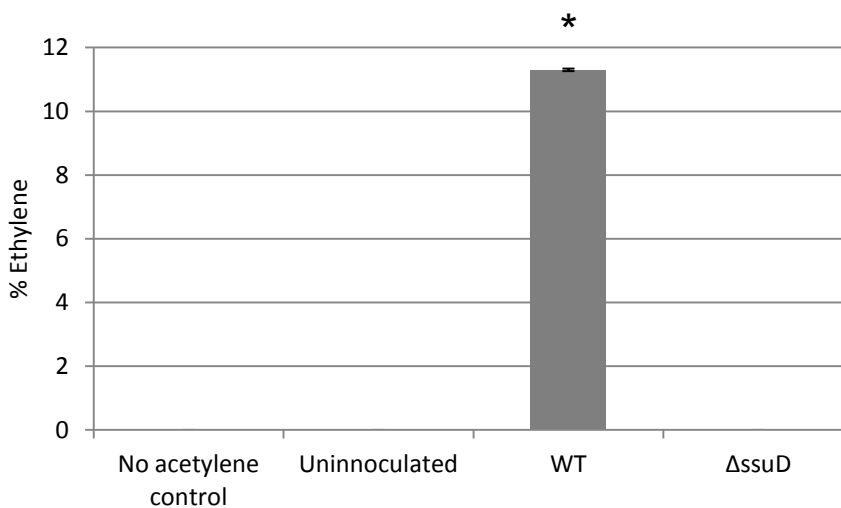

### Figure 23. Acetylene Reduction Assay

Acetylene-ethylene assay done on whole roots from wild type-inoculated soybean and *ΔssuD::kan*-inoculated soybean. The roots were removed and placed in a rubber stoppered tube. Each tube had 10mL of air replaced with acetylene. The roots were incubated overnight with the acetylene. 1mL of gas was removed from each tube and analyzed using gas chromatograph. Conversion of acetylene to ethylene was only found in the wild type-inoculated roots.

\*Significance of wild type comparison with *ΔssuD::kan* (P-value =0.001).

### *The $\Delta ssuD::kan$ Mutant is Defective in Root Colonization*

To determine if the phenotypes observed were due to  $\Delta ssuD::kan$  being absent from the plant nodules, quantitative plating was used. This method allowed for the determination of the number of rhizobia present per gram of nodule. Nodules from wild type-inoculated plants and  $\Delta ssuD::kan$ -inoculated plants were removed, surface sterilized, and crushed. A dilution scheme was plated out to get a countable number of colonies. The colony counts showed a drastic reduction in the amount of rhizobia present in the  $\Delta ssuD::kan$ -inoculated plant nodules (Figure 24). This confirmed the hypothesis that rhizobia were not present in the nodules of  $\Delta ssuD::kan$ -inoculated plants. It would appear that sulfonate utilization is required for either the invasion of or growth within plant nodules.

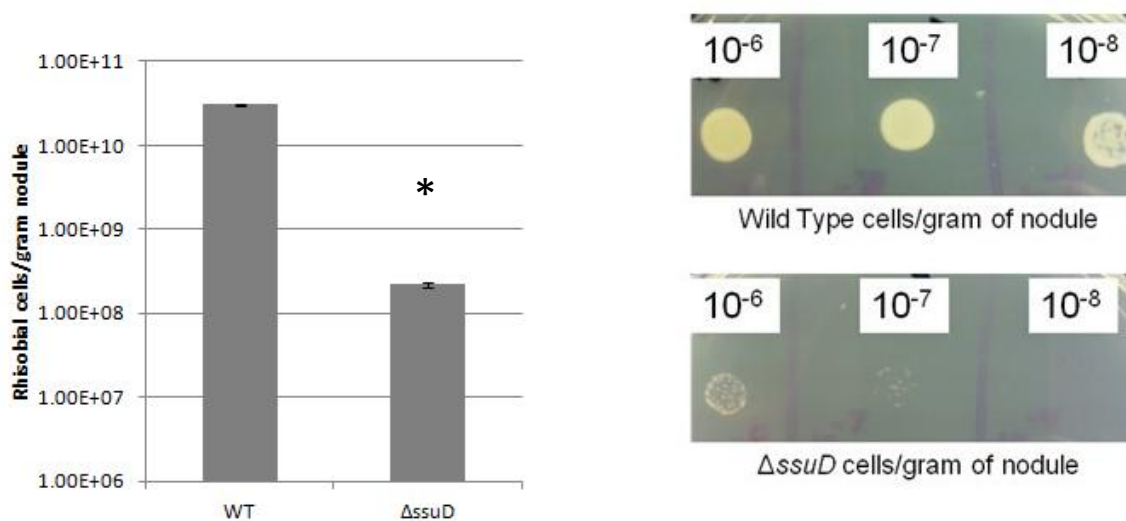

**Figure 24. Colony Counts per Gram of Nodule**

Nodules were harvested from wild type and *AssuD* inoculated plants. The nodules were weighed and then surface sterilized with ethanol for five minutes. Nodules were crushed in saline and plated onto AG growth medium. Colony counts showed 100x fewer *AssuD::kan* mutant cells per gram of nodule as compared to the wild type (left). On the right side are the different dilutions of wild type and *AssuD::kan* cells spotted on AG medium.

\*Significance of *AssuD::kan* comparison with wild type (P-value =0.004).

Due to rhizobia differentiating into bacteroids, vegetative cells that may not revert, it was necessary to confirm the quantitative plating results by visualizing the rhizobia inside the nodules. To examine plant nodules for the presence of rhizobia, GFP marked strains of wild type and  $\Delta ssuD::kan$  were made. Nodules inoculated with the GFP marked strains were harvested approximately three weeks after inoculation, once the nodules fully formed. Nodules were sectioned and viewed using confocal microscopy.

As seen in Figure 25, there was a substantial difference in the number of rhizobia present in the nodule of GFP marked wild type and GFP marked  $\Delta ssuD::kan$ . The reduced number of  $\Delta ssuD::kan$  cells inside the nodule is consistent with the quantitative plating results (Figure 24). Another difference observed was in the location of the cells, in the nodules. The wild type strain was concentrated in the leghemoglobin portion of the nodule where nitrogen fixation should occur, whereas the  $\Delta ssuD::kan$  cells were found in the outer parts of the nodules (Figure 25).

The lack of rhizobia in the central cortical cells is likely responsible for the reduced leghemoglobin seen in nodules of the  $\Delta ssuD::kan$ -inoculated plants. The low concentration of rhizobia in the nodules would also contribute to the smaller size of nodules (Figures 20-22). Additionally, the location and concentration of the  $\Delta ssuD::kan$  cells would lead to the lack of nitrogen fixation seen in  $\Delta ssuD::kan$ -inoculated plants (Figures 23-25).

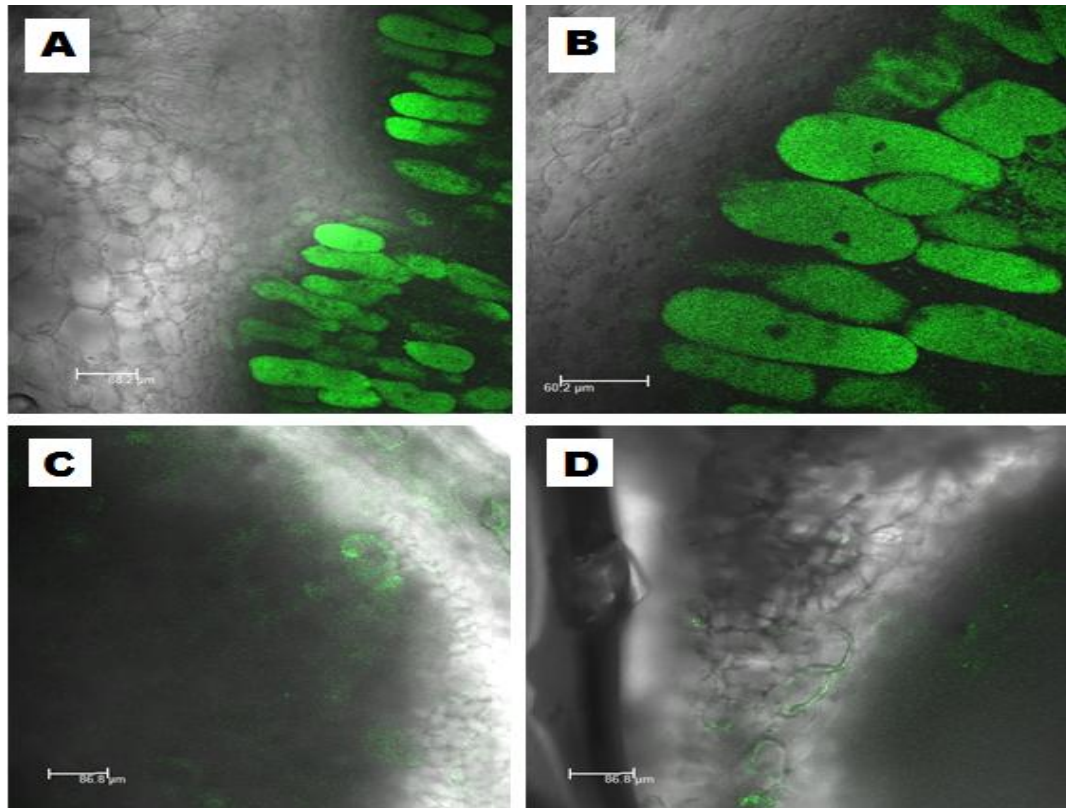

**Figure 25. Confocal Images of GFP Marked Wild Type *B. japonicum* (A and B) and  $\Delta ssuD::kan$  *B. japonicum* (C and D)**

Images were taken three weeks after inoculation. Image A shows a concentration of wild type *B. japonicum* in the cortical cells where the leghemoglobin is present, and not in the exterior nodule cells. Image B shows wild type *B. japonicum* in cortical cells at a higher magnification. Image C shows  $\Delta ssuD::kan$  *B. japonicum* mutant dispersed throughout the nodule and not concentrated in the cortical cells like the wild type. Image D is magnified, showing  $\Delta ssuD::kan$  dispersed throughout the nodule and in low concentrations.

Scanning electron microscopy (SEM) was used in addition to the confocal microscopy on the *B. japonicum* inoculated nodules (Figure 26). Similar results were seen between the confocal imaging (Figure 23) and the SEM images (Figure 26). Once again, the cortical cells were filled with wild type *B. japonicum*, whereas the  $\Delta ssuD::kan$  cells were far more disorganized and not concentrated in the cells. This result confirms that the lack of GFP seen in the  $\Delta ssuD::kan$  mutant nodules was due to the rhizobia not being organized in the nodules.

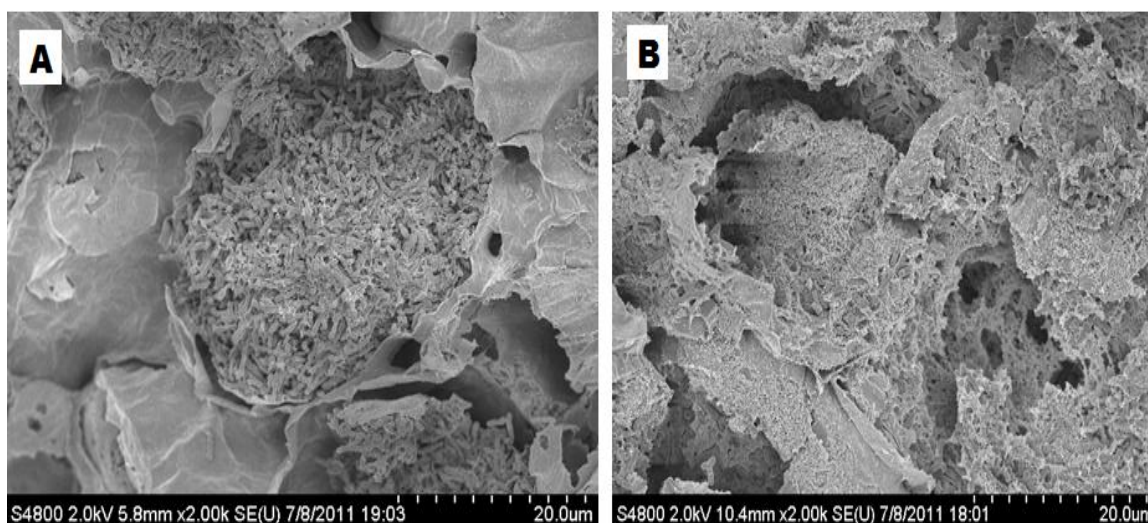
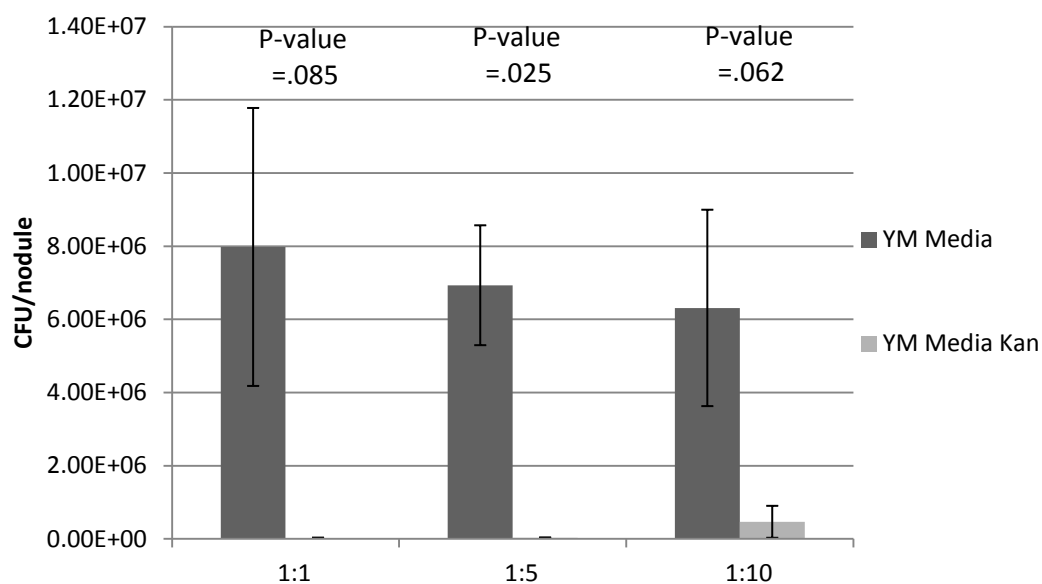

**Figure 26. Scanning Electron Microscopy Images of Wild Type (Left) and  $\Delta ssuD::kan$  Mutant (Right) Inoculated Nodules**

Nodules were harvested three weeks after inoculation once nodules had formed. Image A shows a large number of wild type *B. japonicum* within the cortical cell. Image B shows a decreased number of *B. japonicum* in cortical cells when lacking sulfonate sulfur utilization.

To determine whether the defect in the  $\Delta ssuD::kan$  colonization of nodules was due to defects in invasion or viability, inside plant nodules, competition studies between the wild type and the  $\Delta ssuD::kan$  strain were conducted. Plants were inoculated in three different ratios of wild type to  $\Delta ssuD::kan$ : a 1:1 wild type to  $\Delta ssuD::kan$ , a 1:5 wild type to  $\Delta ssuD::kan$ , and a 1:10 wild type to  $\Delta ssuD::kan$ . Once nodules matured ( $\approx 3$  weeks), they were harvested, crushed, and plated out on YM media and YM media with the antibiotic kanamycin. Both wild type and the  $\Delta ssuD::kan$  mutant were expected to grow on YM, but only the  $\Delta ssuD::kan$  mutant would grow on the YM plates with kanamycin due to the kanamycin resistance cassette.

The plants inoculated with a 1:1 ratio of wild type to  $\Delta ssuD::kan$  had little to no growth of the mutant strain. This suggested that the  $\Delta ssuD::kan$  strain was outcompeted for entry into the nodules by the wild type. In the 1:5 ratio, once again the  $\Delta ssuD::kan$  was outcompeted by the wild type cells. Only in the 1:10 ratio was there any significant amount of  $\Delta ssuD::kan$  seen from the nodules (Figure 27). This experiment demonstrated that the  $\Delta ssuD::kan$  mutant has reduced ability to invade the host plant cells. This competition study shows a significant reduction in the ability of the  $\Delta ssuD::kan$  strain to colonize nodules.



**Figure 27. Competition Studies Between Wild Type and  $\Delta ssuD::kan$  Mutant**

Different ratios of wild type and  $\Delta ssuD::kan$  mutant were inoculated on plants; then nodules were harvested and plated out on YM and YM kanamycin to evaluate ability of the mutant to infect. Even when inoculated with a 1:10 ratio of wild type to  $\Delta ssuD::kan$ , the mutant was completely outcompeted, demonstrating a reliance on sulfonate sulfur sources during infection of the host plant.

Further exploration of  $\Delta ssuD::kan$  the colonization phenotype was done using confocal microscopy (Figure 28). The GFP marked wild type and  $\Delta ssuD::kan$  strain of *B. japonicum* were inoculated onto freshly germinated soybean. One week after inoculation, the roots were examined for signs of invasion such as attaching to the roots and root hair entry.

The confocal images showed no difference in the amount of rhizobia present on the roots, suggesting that there is no problem in communication between the *B. japonicum* strains and host plant (Figure 28A and 28B). There was, however, a difference in the amount of rhizobia invading through the root hairs. Rhizobia entering an infection thread begin dividing and spread down the infection thread. This was seen clearly in the wild type as a solid line of GFP signal throughout the root hair (Figure 28D). However, the  $\Delta ssuD::kan$  mutant has only spotty GFP signal in the root hairs, suggesting a defect in invasion of the root hairs that prevents the  $\Delta ssuD::kan$  strain from growing well in the root hair (Figure 28C).

Another interesting observation was that the  $\Delta ssuD::kan$  cells did induce root hair curling. This result helps confirm the hypothesis that signaling is unaffected by the sulfonate utilization mutation. It was consistent with the mutant inoculated plants being able to form nodules in similar numbers to the wild type-inoculated plants. (Figure 18). Together, these results confirm that plant-microbe signaling is functioning properly.

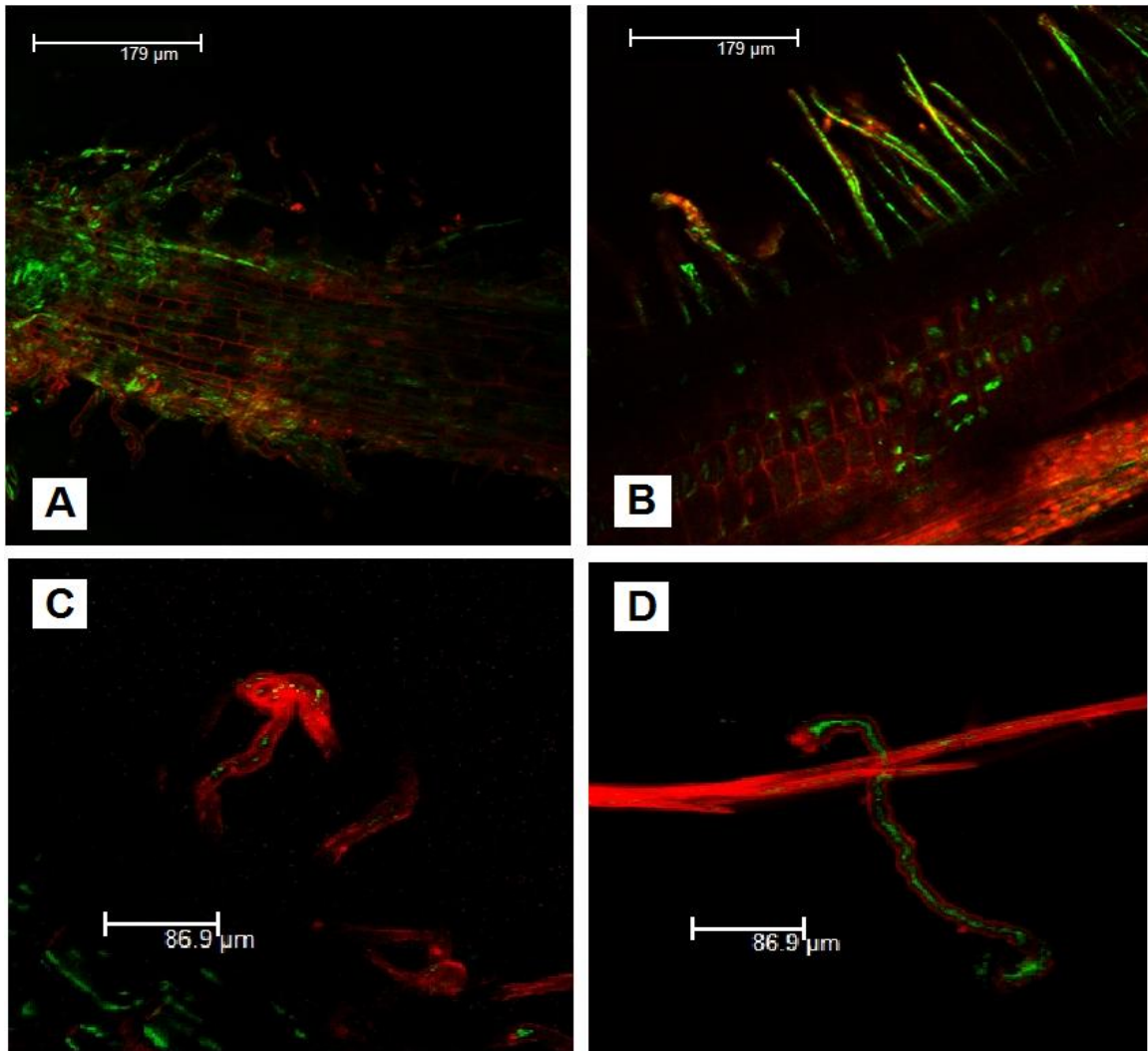

**Figure 28. Confocal Microscopy Images of  $\Delta$ AssuD::kan and Wild Type**

***B. japonicum* Entering Through Root Hairs**

Images of wild type (B and D) and  $\Delta$ AssuD::kan (A and C) plant colonization were taken one week after inoculation. There was no difference in the amount of bacteria present on the exterior of the roots (A and B). There was, however, a significant difference in the amount of bacteria present in root hairs (C and D).

\*Scales for A and B are 179 μm, and scales for C and D are 86.9 μm

The colonization defect seen in  $\Delta ssuD::kan$  is likely caused by slowed growth due to an inability to acquire enough sulfur, or an increased sensitivity to oxidative stress due to low glutathione levels. To test for oxidative sensitivity, cells were grown in AG media, containing both organic and inorganic sulfur sources, with different concentrations of  $H_2O_2$ . Starting at  $5\mu M$  concentration of  $H_2O_2$ , the  $\Delta ssuD::kan$  strain began to show sensitivity to oxidative stress (Figure 29).

As discussed in Chapter One, during infection thread formation, there is an oxidative burst to help form the thread and limit invasion by unwanted bacteria (Passardi et al. 2004). This oxidative burst could explain why the  $\Delta ssuD::kan$  strain was outcompeted by the wild type during colonization of nodules (Figure 27). The oxidative burst would also be a good explanation for why the  $\Delta ssuD::kan$  mutant had spotty growth in the infection thread (Figure 28C). It is clear that a mutation in *ssuD* causes increased sensitivity to oxidative stress and a reduced ability to colonize soybean. It is highly likely that these two observations are linked, and that the increased oxidative sensitivity is preventing effective invasion of plant cells.

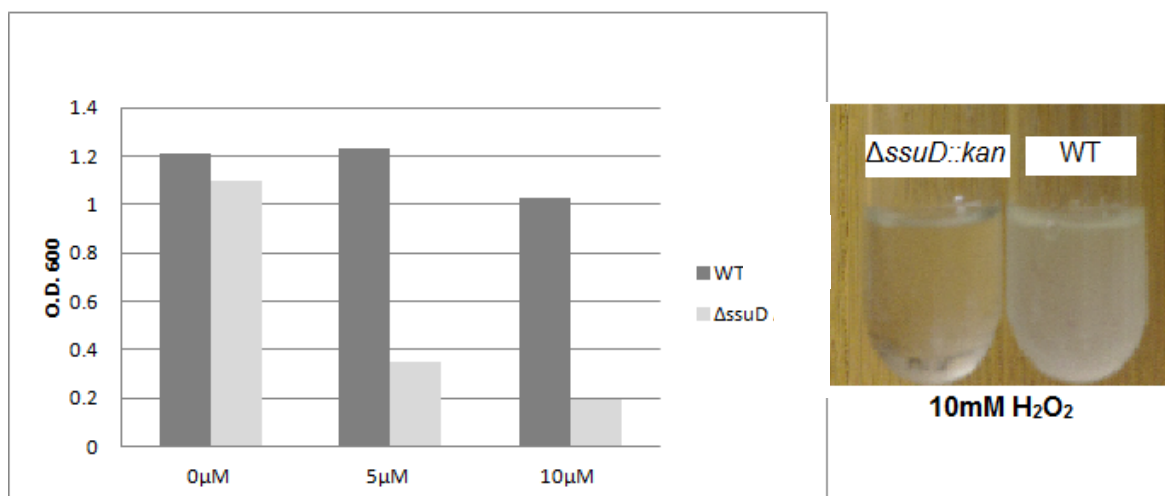

**Figure 29. Sensitivity to Oxidative Stress**

Log phase cells were inoculated into AG growth media with different concentrations of  $H_2O_2$ . The  $\Delta ssuD::kan$  mutant was found to be more sensitive to oxidative stress than the wild type *B. japonicum*. Only one set of readings was taken for each sample.

Growth of the  $\Delta ssuD::kan$  strain showed a significant defect in early colonization of soybean (Figure 28) and a greatly reduced presence within newly formed nodules (Figure 25). This led to a nitrogen limited phenotype in the host legume, as there was no nitrogen fixation occurring. However, confocal images of late stage soybean nodules (six weeks after inoculation) showed signs of  $\Delta ssuD::kan$  recovering and growing inside the nodules (Figure 30). This suggests that sulfonates are not the only sulfur source available to the rhizobia in the nodules. It also suggests that sulfonate defective *B. japonicum* is slowed in colonization of nodules, not completely defective in colonization. However, it is clear that sulfonates are an important sulfur source for the proper colonization and development of nodules. It would appear that there are other sulfur sources available on which to grow. It should be noted that, while there is an increase in the presence of the mutant strain in the nodules, the nodules themselves always remain smaller than the wild type nodules.

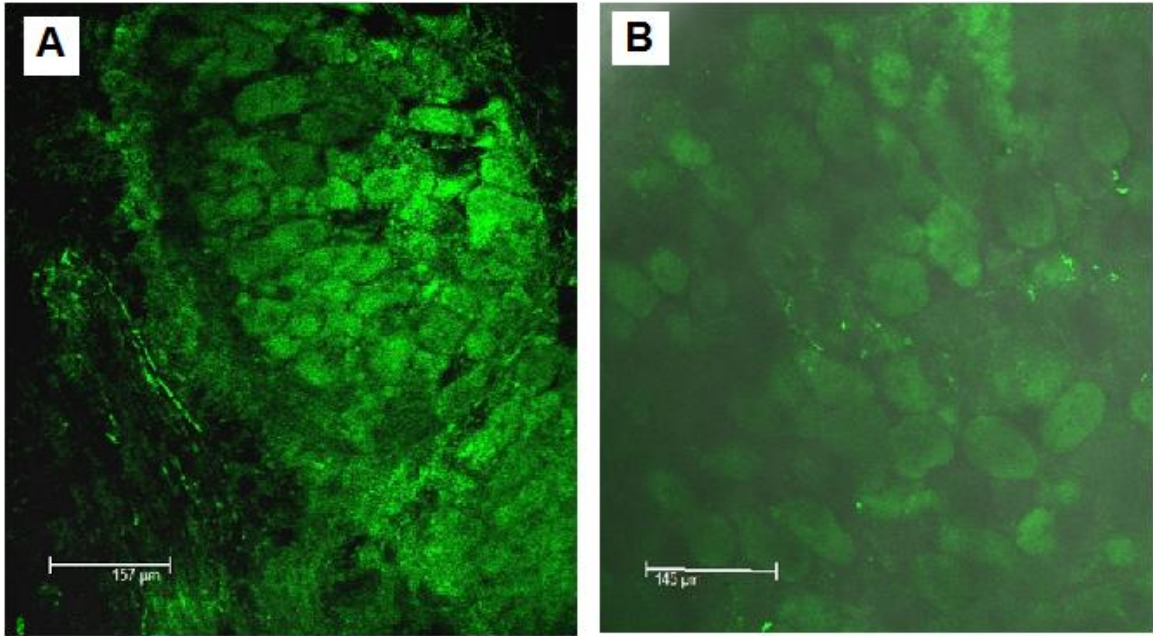
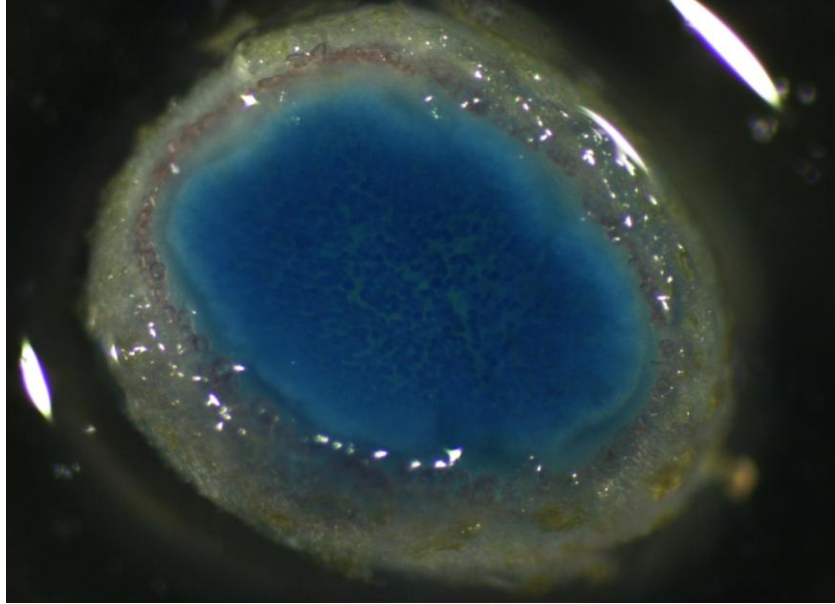

**Figure 30. Confocal Image of Wild Type (A) and  $\Delta ssuD::kan$  (B) Inoculated Nodules**

Images taken five weeks after inoculation show that the  $\Delta ssuD::kan$  mutant numbers begin to recover. It appears that the growth of  $\Delta ssuD::kan$  is not completely arrested, but just significantly slowed due to not being able to utilize sulfonates. The scales for A and B are 157  $\mu\text{m}$  and 145  $\mu\text{m}$  respectively.

*Expression of B. japonicum Sulfatase Genes in Nodules* As stated previously, a majority of sulfur found in soils is organic sulfur in the form of sulfonates and sulfate esters. Sulfonates have been demonstrated to be an important sulfur source for *B. japonicum* when colonizing soybean. However, as has just been shown, sulfonate sulfur does not appear to be the sole source of sulfur available in nodules. This was demonstrated in the ability of  $\Delta ssuD::kan$  strain to slowly recover and grow in nodules.

To test for the possible utilization of sulfate esters in nodules, histochemical staining was done using 5-bromo-4-chloro-3-indolyl sulfate potassium salt (x-sulfate). This substrate turns blue when cleaved by sulfatases. Plants have not been shown to exhibit sulfatase activity. Therefore, any sulfatase activity can be assumed to come from the rhizobia. When nodules were stained, a strong blue color was observed indicating the presence of sulfatase activity in the nodules (Figure 31). It was also noted that the sulfatase activity was concentrated in the leghemoglobin region of the nodule where a majority of the rhizobia reside.



**Figure 31. Wild Type *B. japonicum* Inoculated Nodules Stained with X-Sulfate**

Soybean nodules were sectioned and stained with X-sulfate to detect sulfatase activity.

The soybean nodule stained a dark blue color, indicating the presence of sulfatase activity. Sulfatase activity was strongest in the leghemoglobin region of the nodule where a majority of the rhizobia have been shown to be present.

## *Organization and Annotation of bll4740 Operon*

To examine the role of sulfatases in symbiosis, a transposon mutant library of *B. japonicum* was screened for sulfatase deficient mutants. Transposon mutant 4-16 was found to have reduced sulfatase activity (Figure 32). Sequencing of the disruption revealed an insertion in *bll4740*. To further evaluate the reduced sulfatase phenotype, an insertional mutation was made in *bll4740*.

The insertional mutation of *bll4740* was used to confirm the role of *bll4740* in sulfatase activity. When the  $\Delta bll4740::kan$  strain was plated on minimal media with X-sulfate, greatly reduced sulfatase activity was seen compared to the wild type strain (Figure 33). When plating the rhizobia on the X-sulfate plates, it was interesting to note that the sulfatase activity was much stronger under microaerobic conditions, which simulates the low oxygen environment inside of nodules. This would seem to suggest that sulfatases may be important in the microaerobic environment of plant nodules. Based on the induction of sulfatases under microaerobic conditions and the ability of sulfonate mutants to slowly recover in nodules, it was hypothesized that sulfonate esters are another important sulfur source during symbiosis.

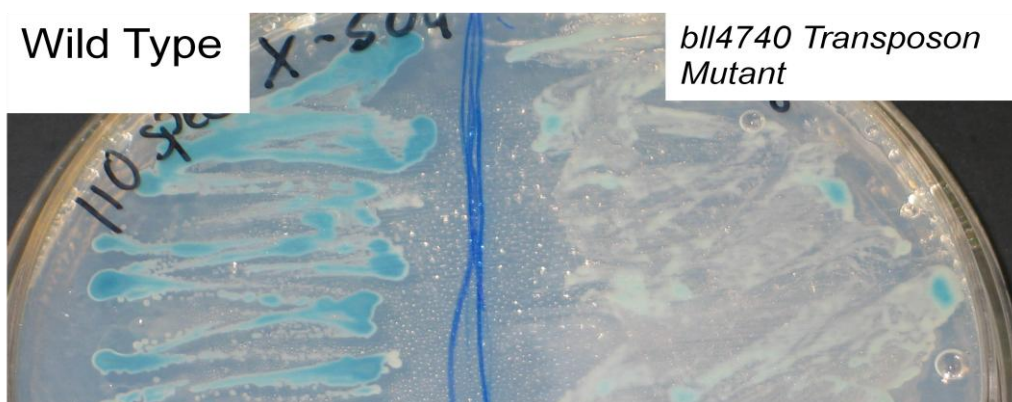

**Figure 32. Wild Type and *bll4740* Transposon Mutant 4-16 on Minimal Media with X-sulfate**

Transposon insertion in *bll4740* was streaked on minimal media plates spread with X-sulfate. The transposon mutant displayed reduced sulfatase activity. This was seen in the strong blue color of the wild type strain (left) indicating sulfatase activity, as opposed to the transposon mutant (right).

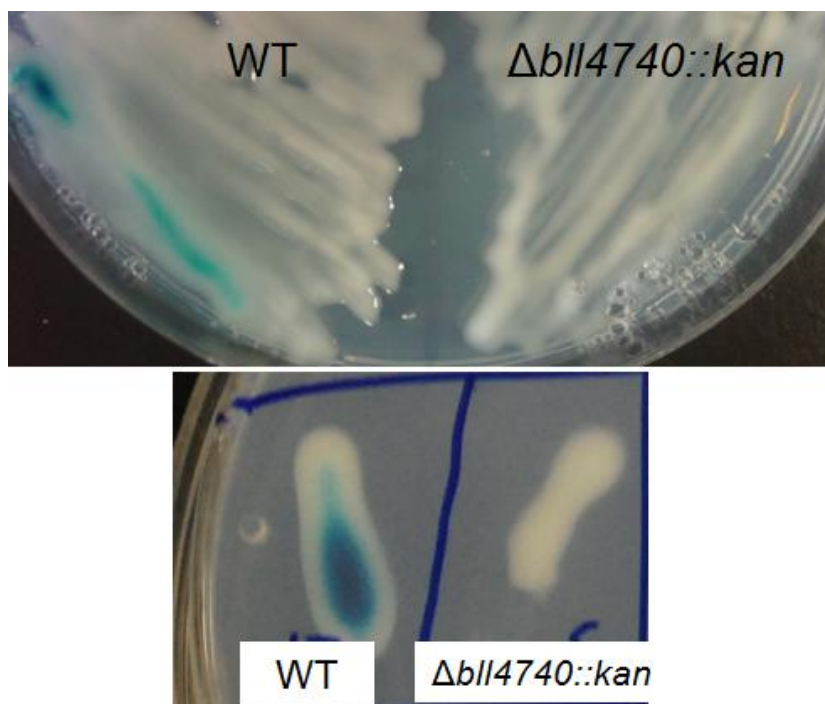

**Figure 33. Wild Type and  $\Delta bll4740::kan$  Mutant on Minimal Media with X-SO<sub>4</sub>**

The  $\Delta bll4740::kan$  mutant and wild type strain were spread on minimal media plates with X-sulfate. The mutant showed little to no sulfatase activity compared to the wild type.

## *Sulfatase Activity is Required for Effective Nitrogen-Fixing*

### *Symbiosis*

To test for the significance of sulfate ester utilization during symbiosis, soybean was inoculated with the *Abll4740::kan* strain of *B. japonicum*. The sulfatase mutant-inoculated plants displayed an acute nitrogen deficiency when compared to the wild type. The leaves had visible signs of chlorosis, and the plants as a whole had stunted growth (Figures 34 and 35).

To corroborate the visual signs of nitrogen deficiency seen in the plants, dry weights were taken and chlorophyll assays were done. Dry weights were taken of the stem and leaves. The *Abll4740::kan*-inoculated plants were found to weigh three times less than the wild type-inoculated plants (Figure 36). This was a similar result to what was seen in the *AssuD::kan*-inoculated plants.

In addition to taking dry weights, chlorophyll assays were done to quantify the nitrogen deficiency. As discussed earlier, there is a direct correlation between chlorophyll content and available nitrogen. The leaves from the *Abll4740::kan*-inoculated plants were found to have less than half the chlorophyll content of the wild type-inoculated plants, further supporting a deficiency in nitrogen (Figure 37). These results strongly suggest an inability of the *Abll4740::kan* strain to form an effective nitrogen-fixing symbiosis with soybean. This could be due to an inability to invade or grow once inside of the plant nodules.

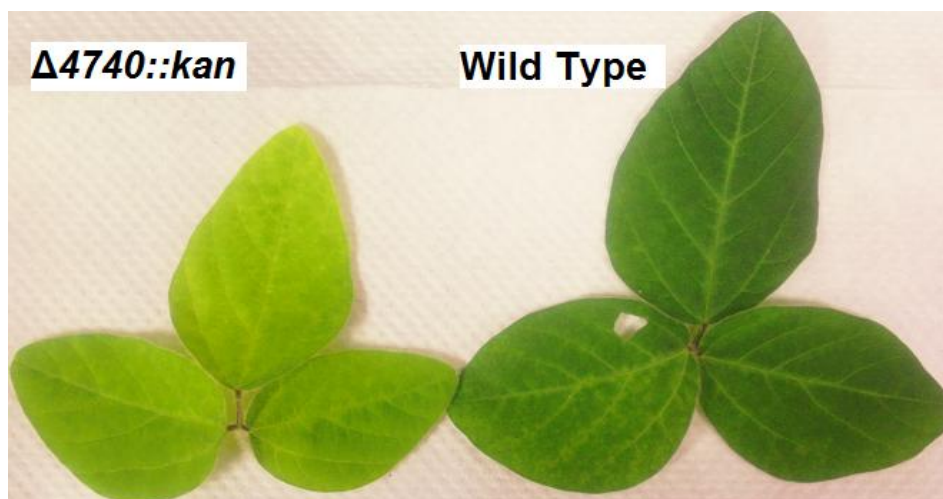

**Figure 34. Image of Leaves from  $\Delta bll4740::kan$  Inoculated Plant and Wild type-inoculated Plant**

Leaves were taken four to five weeks after inoculation. Leaves from the  $\Delta bll4740::kan$ -inoculated plant (left) show signs of chlorosis when compared to the wild type (right), consistent with a nitrogen deficiency



**Figure 35. Whole Soybean Plants Inoculated with  $\Delta bll4740::kan$  and Wild Type *B. japonicum***

Plants were harvested four to five weeks after inoculation. The  $\Delta bll4740::kan$ -inoculated plants had significantly less growth than the wild type-inoculated plants. The stunted growth seen in the  $\Delta bll4740::kan$ -inoculated plants suggests a nitrogen deficiency.

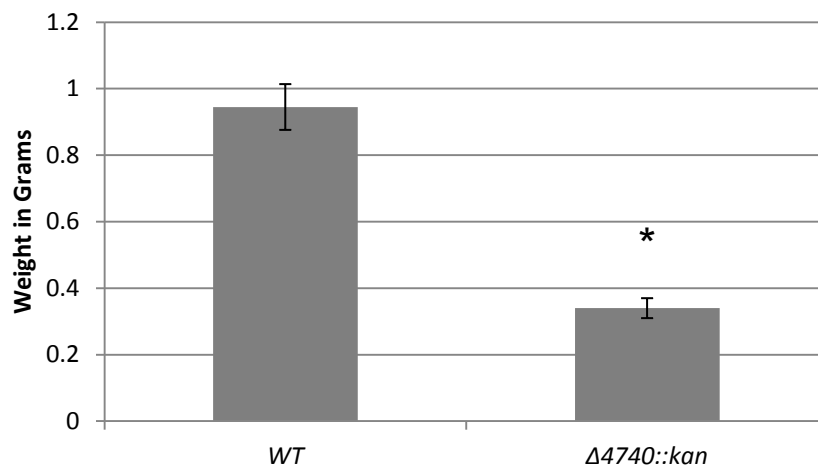

**Figure 36. Dry Weights from Wild Type and  $\Delta bll4740::kan$  Inoculated Plants**

Dry weights of leaves and stem were taken four to five weeks after inoculation. A significant phenotype was displayed by the  $\Delta bll4740::kan$  inoculated plants. The average dry weight was a third of the wild type-inoculated plants.

\*Significance of  $\Delta bll4740::kan$  compared with wild type (P-value =0.01).

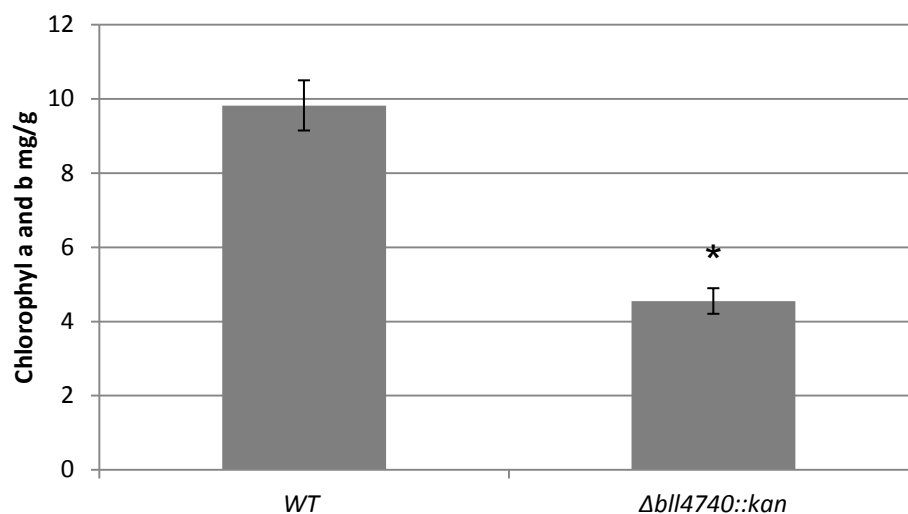

**Figure 37. Measurement of Chlorophyll Content for Wild Type and  $\Delta bll4740::kan$  Mutant Inoculated Plants**

Plants were harvested four to five weeks after inoculation. 50mg-100mg of leaf material was used for acetone extraction of chlorophyll. The  $\Delta bll4740::kan$ -inoculated soybean plants were found to have significantly less chlorophyll content per gram of leaf material than the wild type-inoculated plants.

\*Significance of  $\Delta bll4740::kan$  compared with wild type (P-value <0.001).

### *Nodule Phenotype in $\Delta bll4740::kan$ Inoculated Plants*

Due to the nitrogen limited phenotype in  $\Delta bll4740::kan$  inoculated plants, it was hypothesized that, similar to the sulfonate mutant,  $\Delta bll4740::kan$  was deficient in colonizing the plant roots. To begin answering this question, nodules were examined for problems in development. When the  $\Delta bll4740::kan$  inoculated plant roots were compared to the wild type-inoculated plants, a difference in nodule size was observed (Figure 38). Early stages of the nodule development showed a significant difference in the color and size of the nodules. The wild type nodules were large and pink in color, whereas the  $\Delta bll4740::kan$  nodules were small and white, lacking in leghemoglobin.

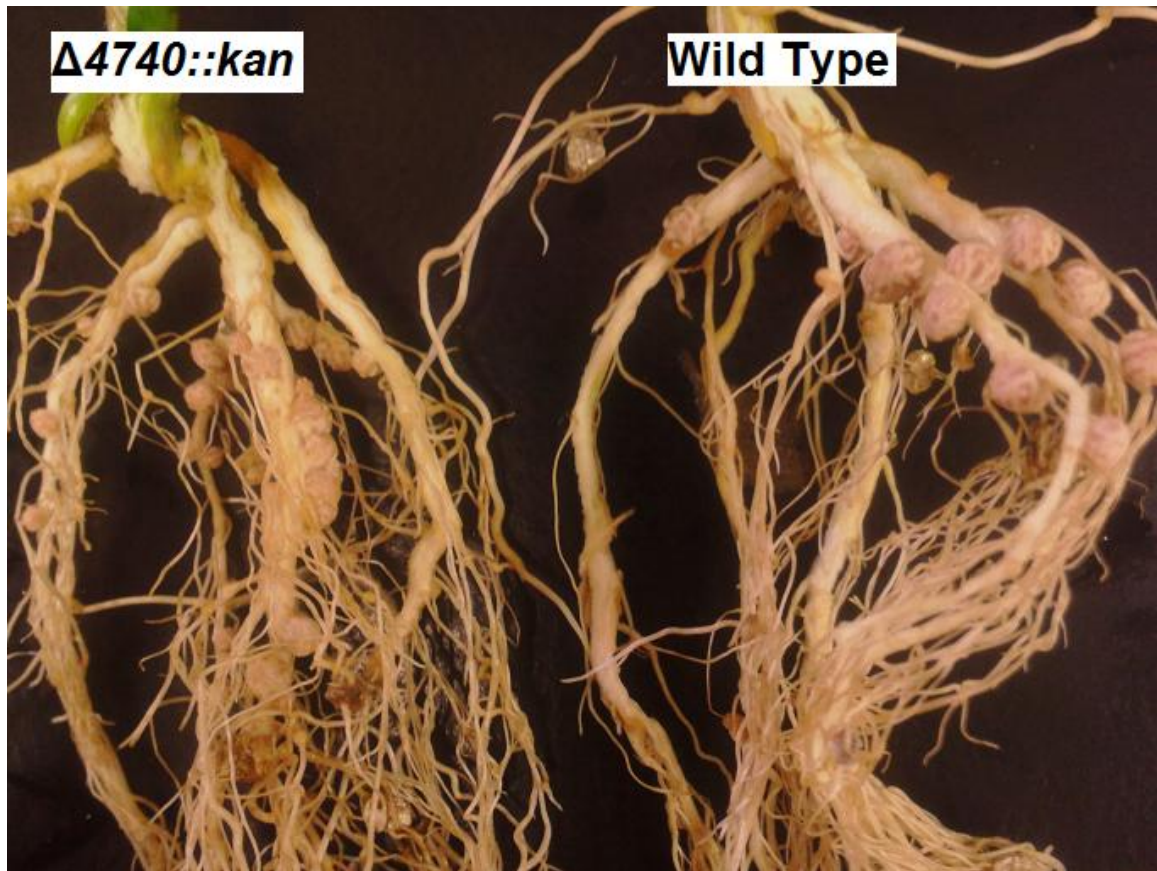

**Figure 38. Comparison of Wild Type and  $\Delta bll4740::kan$  Mutant Inoculated Roots**  
Roots were examined four to five weeks after inoculation. The wild type nodules (right) were larger and tended to be a darker pink color. The  $\Delta bll4740::kan$  mutant nodules (left) showed stunted growth and began to show pink color two weeks later than the wild type.

Further analysis of the nodules was done by staining nodules for sulfatase activity, using X-sulfate; and the nodules were examined for leghemoglobin by sectioning (Figure 39). The *Abll4740::kan*-inoculated nodules stained with X-sulfate right after nodule development (two weeks after inoculation) showed no sulfatase activity (Figure 39B). By contrast the wild type-inoculated nodules did show sulfatase activity (Figure 39A). It should be noted that late stage nodules (six weeks and on) inoculated with *Abll4740::kan* will show some sulfatase activity (Figures 39E and 39F). This makes it likely that the complete lack of sulfatase seen in the early stage nodules is due to greatly reduced numbers of the *Abll4740::kan* strain in the nodules.

Also important to note was the development of leghemoglobin. Healthy nodules appear pink to red in color due to significant amounts of leghemoglobin within the cortical cells. When examining the *Abll4740::kan*-inoculated nodules at three weeks, very little leghemoglobin was observed. In contrast, the wild type nodules were almost red in color due to the high amounts of leghemoglobin present (Figures 39C and 39D). It should be noted that allowing the plants to go to maturity did allow for the recovery of leghemoglobin within the nodules, but the nodules never recovered in size. These results suggest that the disruption of sulfatase genes either affects invasion of the plant by the rhizobia or it affects rhizobial growth once inside the nodules. Ultimately, reduced ability to utilize sulfonate esters causes upsized nodules and a lack of nitrogen fixation due to reduced viability of the *Abll4740::kan* strain in the plant system.

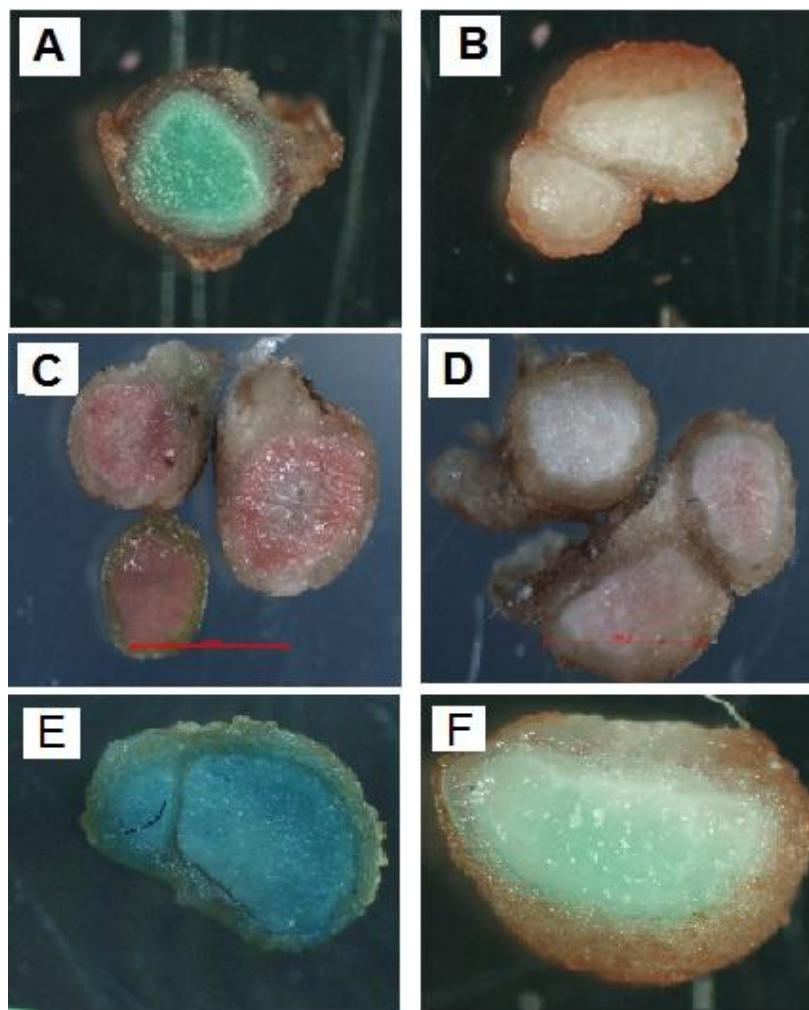
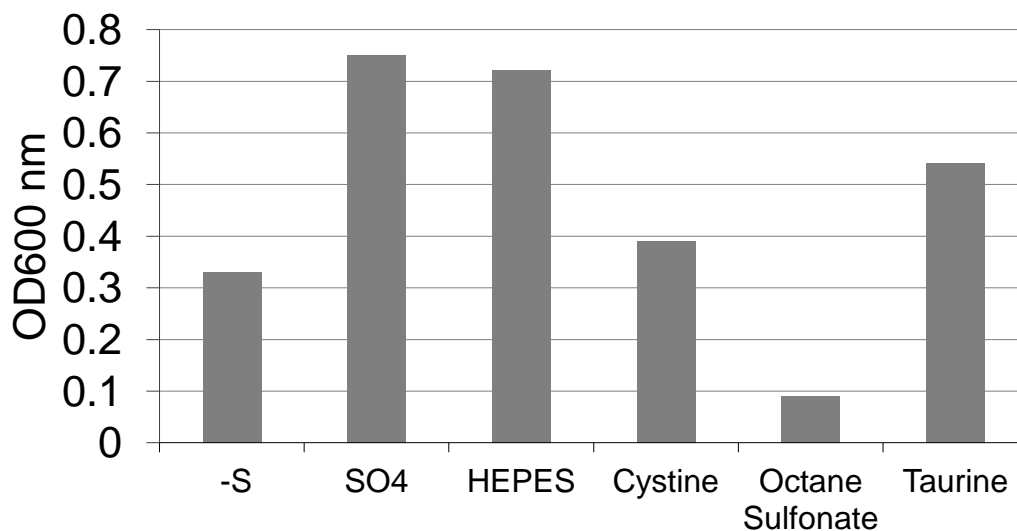

**Figure 39. Nodules from Wild type-inoculated (A, C, and D) and  $\Delta bll4740::kan$ -Inoculated (B, D and F) Plants Stained with X-sulfate (A, B, E, and F), and Unstained (C and D).**

Nodules (A-D) were harvested shortly after formation at three weeks after inoculation. Recently formed  $\Delta bll4740::kan$  mutant nodules lack sulfatase activity (B). In addition to the  $\Delta bll4740::kan$  nodules having no sulfatase activity, little to no leghemoglobin was seen (D). Wild type showed sulfatase activity at this early stage as well as a substantial amount of leghemoglobin (A and C). Plants harvested after plants reached maturity (six weeks) had nodules stained with X-sulfate to detect sulfatase activity. The wild type-inoculated plant nodules had significant sulfatase activity while the  $\Delta bll4740::kan$ -inoculated plant nodules only showed slight expression (E and F).

## *Sulfur Utilization in Sinorhizobium meliloti* RM1021

The ability of *Sinorhizobium meliloti* RM1021 to utilize various sulfur sources was examined by growth in minimal media with different sulfur sources. Sulfur-starved cells were inoculated into minimal media with a single sulfur source, and end point OD<sub>600</sub> was taken to determine growth. *S. meliloti* was able to utilize a wide variety of sulfur sources including: sulfate, sulfonates, sulfate esters, and cysteine. *S. meliloti* was able to utilize sulfonates almost as well as sulfate. However, little to no growth was seen on the long chain sulfur source octane sulfonate (Figure 40).



**Figure 40. Growth of *S. meliloti* on Multiple Sulfur Sources**

Cultures were sulfur starved before inoculating into minimal media containing 10mM carbon source, 10mM nitrogen source, cobalt chloride, biotin, and 1mM sulfur source. OD<sub>600</sub> readings were used to determine the growth of wild type *S. meliloti*. *S. meliloti* was able to grow on sulfate and the sulfonate HEPES equally well. No significant growth was observed with octane sulfonate.

## *Expression of Sulfate Binding Protein and Taurine Transport Genes in Free Living Conditions*

To better understand sulfur utilization in *S. meliloti*, reporter fusion strains were acquired, from Dr. Finan at McMaster University, and used to determine the regulation of *sbp*, *tau*, and *ssu* sulfur utilization genes. Taurine and sulfate were the first two sulfur sources examined. Reporter fusion strains containing *tdimer2*, a red fluorescence protein (RFP), and *gusA* fused to the *tauABC* operon and *sbp* operon, were used. These strains were grown on different sulfur sources and expression was examined using a p-nitrophenyl  $\beta$ -D-glucuronide (PNPG) assay.

The sulfate binding protein (*sbp*) gene expression was similar to the expression pattern seen in *E. coli*. In *E. coli*, when sulfate is scarce, *sbp* is expressed at higher levels to aid in sulfur scavenging. This was also seen in the *sbp-gusA-rfp* strain of *S. meliloti* when grown with no sulfur source (Figure 41). Additionally, elevated levels of expression were seen when cells were grown on alternative sulfur sources, such as HEPES and taurine, as they create sulfur limiting conditions. This result was also consistent with what is seen in the model organism *E. coli*. Reduced expression was seen when cells were grown on excess sulfate or cystine. This indicates that the *sbp* operon is ultimately regulated by the internal sulfur pools, likely sensed through cysteine levels, as is the case in *E. coli*.

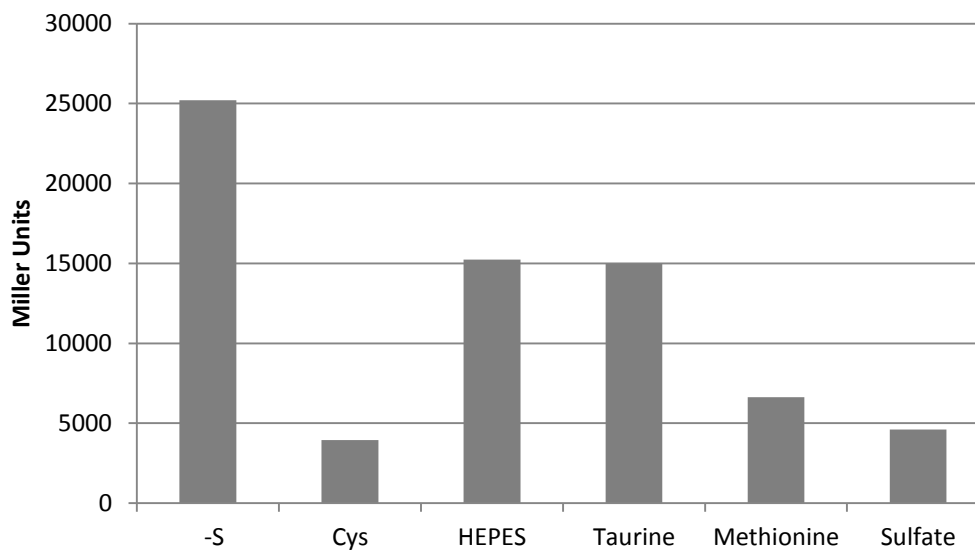

**Figure 41. PNPG Assay of *sbp-gusA-rfp* Strain in Different Sulfur Conditions**

Cultures were grown to mid log phase in LBMC before washing and inoculating into minimal media for induction experiments. Gus activity of *sbp* was measured by PNPS hydrolysis. Induction of *sbp* was observed under sulfur limiting conditions and on sulfonate sulfur sources, compared to growth on cystine or sulfate.

Examination of the taurine (*tau*) reporter fusion on different sulfur sources revealed significantly lower levels of expression on all sulfur sources when compared with *sbp*. Only trace amounts of expression were seen on most sulfur sources. Induction was only seen when the cells were grown on taurine. This suggests that taurine is the inducer for this operon (Figure 42). In addition to using taurine as a sulfur source, *S. meliloti* was able to utilize it as a nitrogen source making it unique among sulfur sources tested in this study. This dual use for taurine may explain why the induction of the *tau* operon was not affected by the internal sulfur pool, but rather by the presence of the substrate taurine.

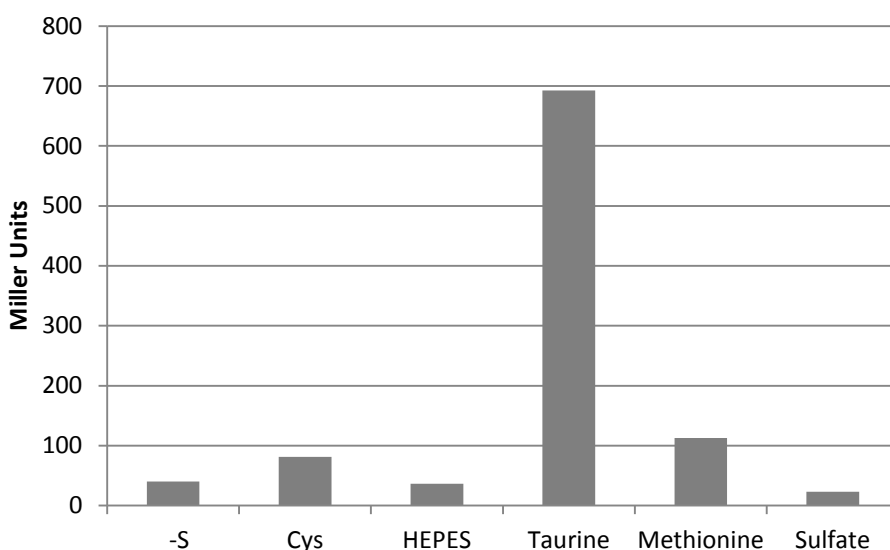

**Figure 42. Expression of *tauABC-gusA-rfp* strain in Different Sulfur Conditions**

Cultures were grown to mid log phase in LBMC before washing and inoculating into minimal media for induction experiments. The *tauABC-gusA-rfp* fusion strain was inoculated into minimal media containing single sulfur sources. Gus activity was measured by PNPS hydrolysis. The *tau* operon was found to be induced only in the presence of its substrate taurine.

Once the expression pattern of the *tau* operon and *sbp* operon were understood, both fusion strains were inoculated onto alfalfa (*Medicago sativa*) to determine expression during colonization and nitrogen-fixing symbiosis. Alfalfa was inoculated with the strains, *tauABC-gusA-rfp* and *sbp-gusA-rfp*, (Figure 43) and expression of these genes was examined at weekly intervals. The alfalfa roots were checked for signs of *tauABC* expression or *sbp* expression by staining with 5-bromo-4-chloro-3-indolyl glucuronide (X-Gluc), or by examining the roots under the confocal microscope for RFP signal.

*S. meliloti* expressed *sbp* at all stages of nodulation. However, it was noted that the expression of *sbp* inside of nodules was focused in zone I and zone II of the nodule, where active infection of newly formed cells occurs. Once the rhizobia entered cortical cells and differentiated, expression of *sbp* was no longer observed, suggesting that the rhizobia are moving from sulfur limited conditions to sulfur excess conditions (Figure 44).

In contrast to what was seen in the *sbp* fusion strain, the *tauABC-gusA-rfp* reporter fusion showed strong expression during the first two weeks after inoculation and reduced expression as the nodules matured (Figure 44). This high expression early on in nodule development led to the hypotheses that taurine utilization is important for infection and establishment of nitrogen fixing symbiosis. However, when plant experiments were done with  $\Delta tau$  mutants, no phenotype was observed, which seems to contradict the expression seen. This lack of phenotype could be due to redundancy for taurine utilization provided by the sulfonate sulfur utilization genes (*ssu* operon).

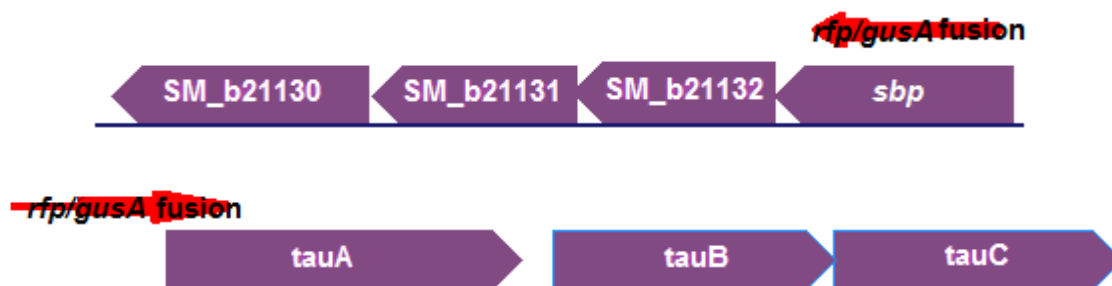

**Figure 43. Construction of Reporter Fusions for *tau* and *sbp* operons**

Both constructs did not appear to disrupt function and are clearly under the control of the operon promoter (modified from Cowie, 2006).

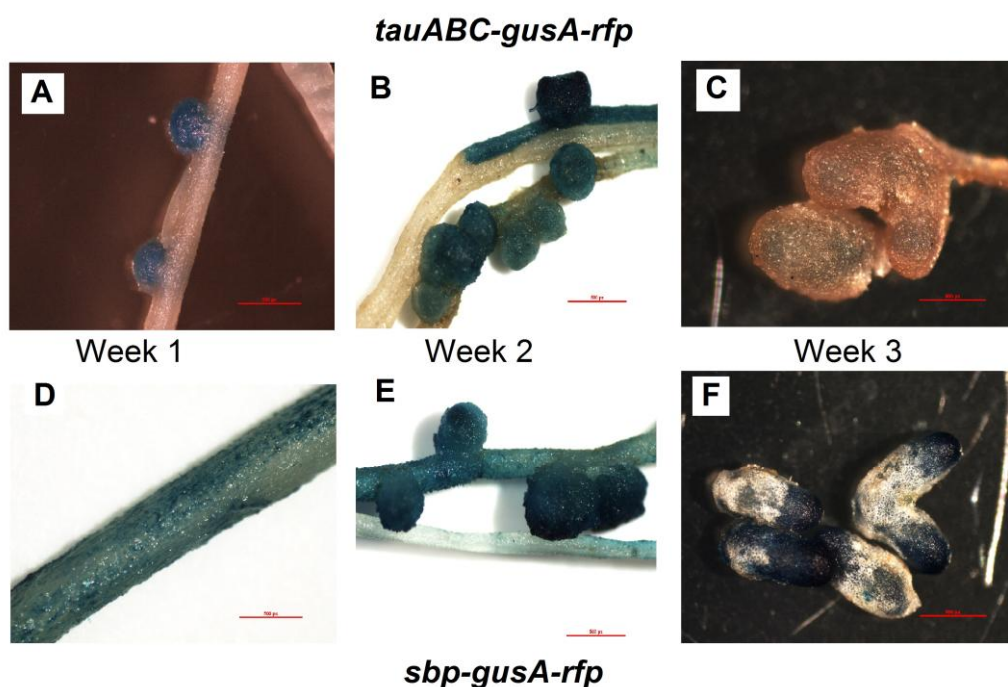
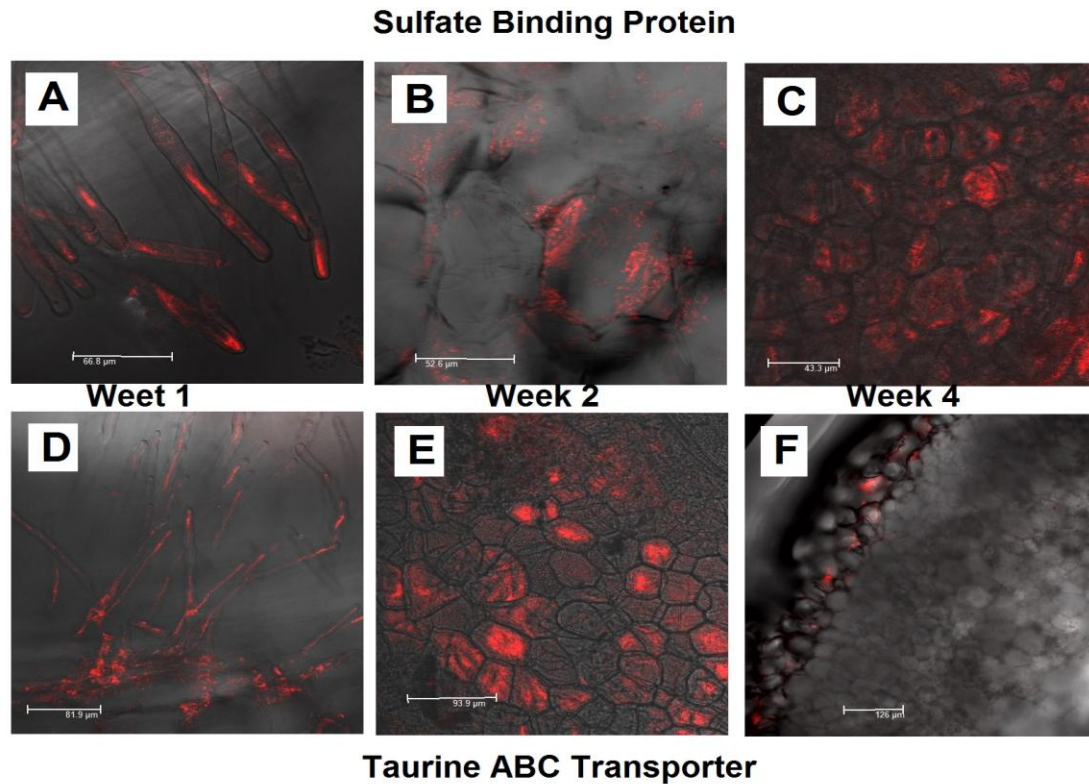

**Figure 44. Fusion Strain-Inoculated Alfalfa Stained with X-Gluc**

A,B and C show *tauABC-gusA-rfp* inoculated alfalfa stained with X-gluc at weekly intervals. D, E, and F show *sbp-gusA-rfp* inoculated alfalfa stained with X-gluc at weekly intervals.

Expression of *sbp* and the *tauABC* operon were also observed using confocal microscopy. Roots were taken at weekly intervals and examined for expression during invasion and establishment a nitrogen-fixing symbiosis. The expression pattern seen for *sbp* was similar to what was observed in the X-gluc staining. Expression was seen during invasion, nodule formation, and in mature nodules (Figure 45). Unfortunately, the confocal images were concentrated in regions of expression, and the magnification was too high to see the localization of the *sbp* expression seen in the X-gluc staining.

Expression of the *tau* operon viewed with the confocal microscope confirmed the expression seen with X-gluc staining. There was significant expression in root hairs during invasion and in the developing nodules (Figure 45). However, expression attenuated once the nodules reached maturity. This, once again, suggested that taurine was highly utilized during the establishment of symbiosis. However, the work with *tau* mutants showed no phenotypes. This makes it likely that there are either multiple types of sulfur available in addition to taurine, or that taurine can be utilized through the *ssu* operon.



**Figure 45. Confocal Images of *tauABC-gusA-rfp* and *sbp-gusA-rfp* Reporter Fusions in Alfalfa**

Confocal images were taken at weekly intervals after inoculation of alfalfa. A,B and C show *sbp-gusA-rfp* inoculated alfalfa at weekly intervals. D, E, and F show *tauABC-gusA-rfp* inoculated alfalfa at weekly intervals. Scales for the pictures are as follows: A) 66.8  $\mu\text{m}$ , B) 52.6  $\mu\text{m}$ , C)43.3  $\mu\text{m}$ , D)81.9  $\mu\text{m}$ , E) 93.9  $\mu\text{m}$ , F) 126  $\mu\text{m}$ .

## *Role of Sulfonate Utilization in S. meliloti Symbiosis*

To examine the expression of sulfonate utilization genes in *S. meliloti* two reporter fusion strains were used, SM\_b21691::*gfp-lacZ* and SM\_b20568::*gfp-lacZ*. Surprisingly, SM\_b21691 had not been annotated as a sulfonate gene. However, SM\_b21691 was surrounded by alkane transporter genes and an NADH-dependent FMN reductase. Additionally, SM\_b21691 was annotated as a monooxygenase, making it likely that it was a sulfonate monooxygenase similar to *ssuD*, which it will be called for the remainder of this paper (Figure 46).

The SM\_b20568::*gfp-lacZ* reporter fusion was believed to be under the control of the alkane sulfonate ABC transporter genes preceding it but, SM\_b20568 is annotated as an amino acid ABC transporter substrate binding protein. The exact location of the fusion was not known; however, this strain was used in hopes of observing the sulfonate gene expression patterns (Figure 46).

According to the gene map for the *ssuD* (SM\_b21691), the reporter gene fusion created an insertional mutation. Thus, the strain should have a growth phenotype when grown on sulfonates. To test this, the strain was grown on the sulfonate HEPES, and the *ssuD* insertional mutant did have reduced growth on sulfonates when compared with the wild type, confirming at least a partial defect in sulfonate utilization (Figure 47).



**Figure 46. Reporter Fusions for *SM\_b20569* and *SM\_b21691 (ssuD)* Operon**

The fusion insertion for *SM\_b20568* appeared to be just upstream of *SM\_b20569* and not disrupting gene function. The fusion insertion for *SM\_b21691 (ssuD)* is within the gene, resulting in disruption of the *ssuD* gene (modified from Cowie, 2006).

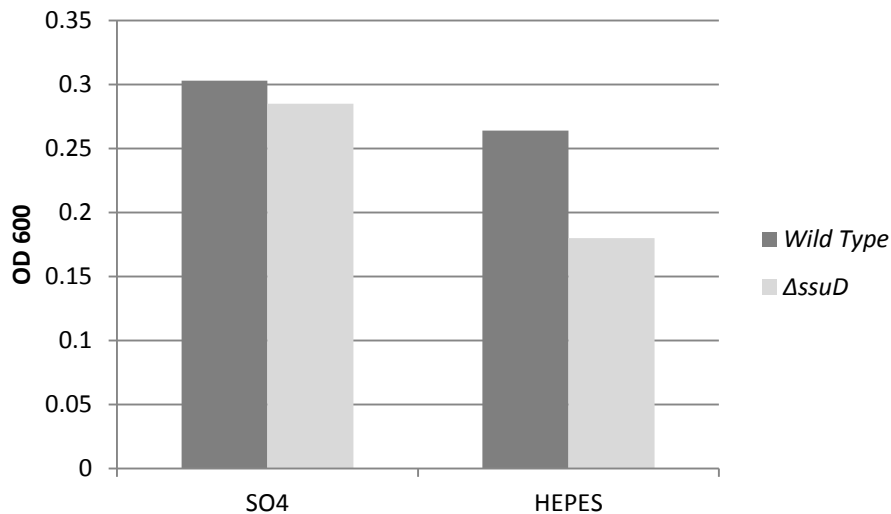
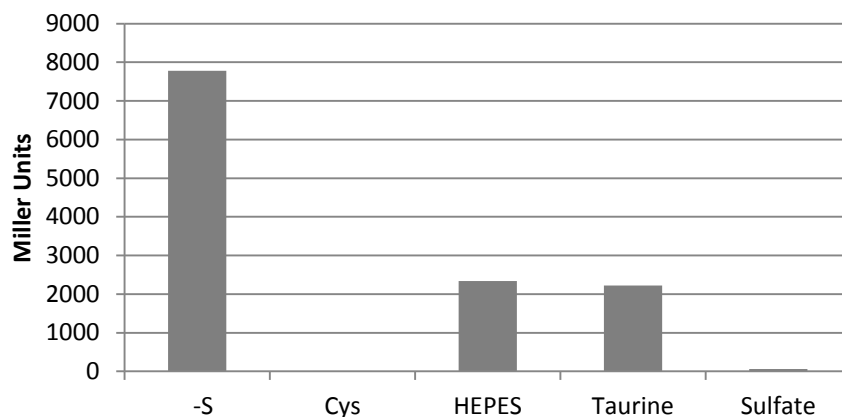

**Figure 47. Growth of Wild Type vs.  $\Delta ssuD::gfp-lacZ$**

Cultures were sulfur starved on minimal media before inoculating into fresh minimal media with 1mM of appropriate sulfur source. The *ssuD* fusion strain was believed to be an insertional mutant for sulfonate monooxygenases. The results demonstrate that sulfonate utilization was effected and growth was reduced in comparison with the wild type strain.

Expression of *ssuD* was examined in the  $\Delta ssuD::gfp-lacZ$  strain under several sulfur conditions, to determine under what conditions it is induced. Similar to the model system, *E. coli*, expression of the sulfonate sulfur utilization genes appeared to be tied to internal sulfur levels, as opposed to the presence of the sulfonate substrate. This was seen in the  $\beta$ -galactosidase assay when sulfur limited conditions produced the highest levels of expression as compared to sulfur excess conditions that showed very little expression of the *ssu* genes (Figure 48).

Expression of *SM\_b20568-gfp-lacZ* in the fusion strain was greatly reduced compared to the  $\Delta ssuD::gfp-lacZ$  strain (Figure 49B). The  $\beta$ -galactosidase assay of *SM\_b20568* expression revealed very low expression (Figure 49A). This makes it likely that *SM\_b20568* is not under the control of the sulfonate ABC transport genes, as the highest expression should have been under sulfur-limiting conditions. Due to the expression seen in this experiment, it is likely that the insertion was much closer to *SM\_b20568* and under a separate promoter from the sulfonate ABC transporter genes. Additionally, *SM\_b20568* was annotated to be apart of amino acid transport, which should not be induced by different sulfur conditions. However, slight induction was seen under sulfur limiting conditions and after growth on alkane sulfonates, so the upstream sulfonate genes may have some influence on the expression of *SM\_b20568* but that expression was far less than what was seen in the  $\Delta ssuD::gfp-lacZ$  strain (Figure 49B).



**Figure 48. Expression of *AssuD::gfp-lacZ* in Different Sulfur Conditions**

Cultures were grown mid log phase in LBMC before washing and inoculating into minimal media for induction experiments. Expression of the  $\Delta$ *AssuD::lacZ-gfp* fusion was measured using a  $\beta$ -galactosidase assay after induction in different sulfur conditions. Highest expression was seen when no sulfur was added, and moderate expression was seen after growth on HEPES or taurine.

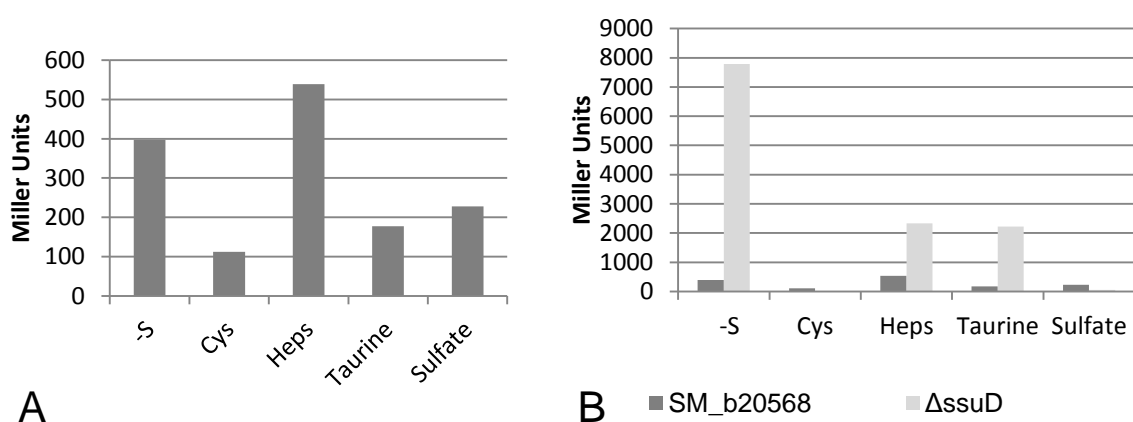

**Figure 49. Induction of *SM\_b20568-gfp-lacZ* in Different Sulfur Sources**

Cultures of *SM\_b20568-gfp-lacZ* were grown on LBMC to mid log phase washed and inoculated into several different sulfur sources for overnight. The *SM\_b20568-gfp-lacZ* fusion showed very little induction compared with the  $\Delta$ *AssuD::gfp-lacZ* strain as seen in graph B. There were some differences, suggesting that *SM\_b20568* may be slightly influenced by the upstream sulfatase genes.

Having an insertional mutation of the *ssuD* gene in the  $\Delta ssuD::gfp-lacZ$  *S. meliloti* strain allowed for the examination of the role of sulfonates in the *S. meliloti*-alfalfa model system. It has already been demonstrated that *S. meliloti* is able to utilize sulfonates almost as well as sulfate for growth. It was also demonstrated earlier in this study that sulfonate utilization is vital for effective nitrogen-fixing symbiosis between *Bradyrhizobium japonicum* and soybean. Thus, it was hypothesized, that the need for sulfonate utilization during colonization and symbiosis seen in *B. japonicum* would be conserved in *S. meliloti*. To test this hypothesis, alfalfa seeds were surface sterilized and germinated. Once germinated, the seedlings were inoculated with the appropriate strains of *S. meliloti* and allowed to grow for four weeks. After this period of time, the  $\Delta ssuD::gfp-lacZ$  reporter strain showed a nitrogen deficient phenotype similar to what was seen in *B. japonicum* (Figure 50). This nitrogen deficiency was seen in the stunted growth of the alfalfa plants and yellowing of the leaves. The *SM\_b20568-gfp-lacZ* fusion strain acted as control, as no nitrogen deficiency was observed in this strain.

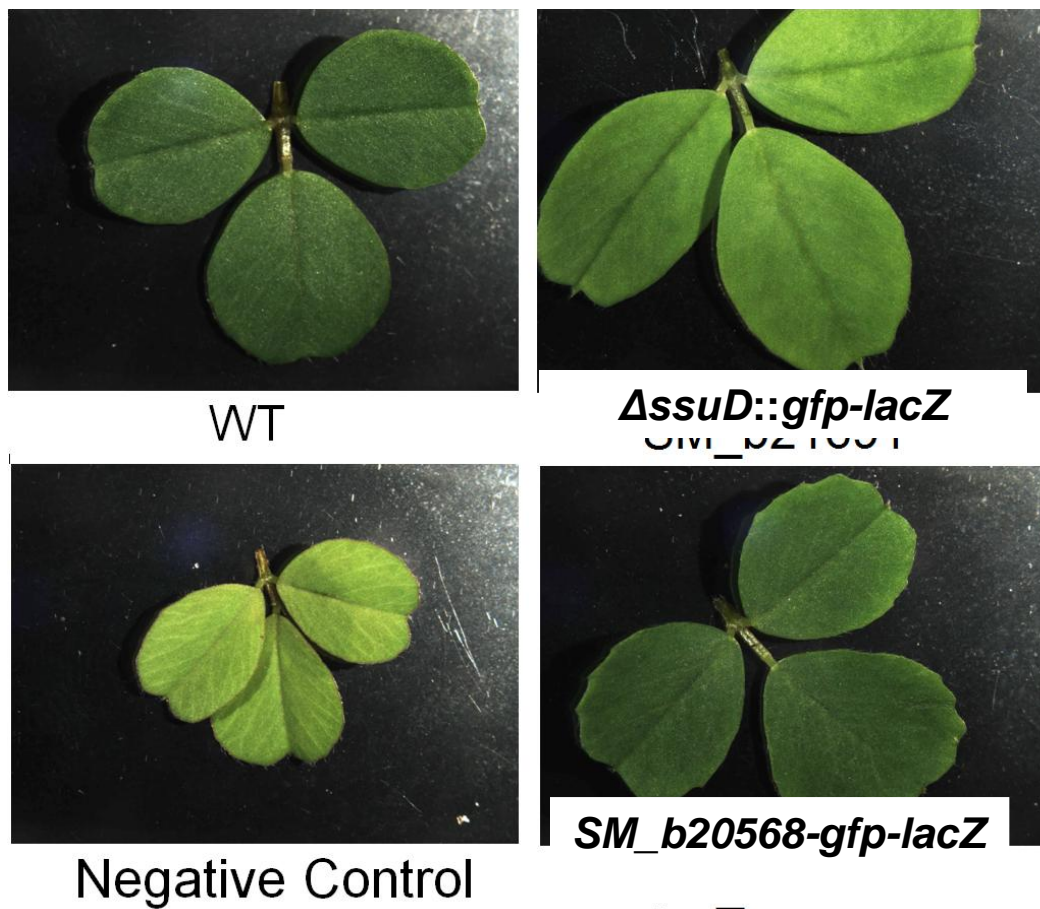

**Figure 50. Nitrogen Limitation Phenotype in Sulfonate Mutant-Inoculated Alfalfa**

Plants were harvested four weeks after inoculation with wild type, *SM\_b20568-gfp-lacZ*, and *AssuD::gfp-lacZ*. The sulfonate utilization mutant-inoculated plant showed signs of nitrogen deficiency, as seen by the yellowing of the leaves.

In addition to observing a nitrogen deficiency in the leaves of  $\Delta ssuD::gfp-lacZ$  inoculated plants, the root nodules were examined for developmental problems. The  $\Delta ssuD::gfp-lacZ$  inoculated plants had underdeveloped nodules that appeared round like determinate nodules, as opposed to elongated like indeterminate nodules (Figure 51). This nodule phenotype is very similar to the nodule phenotype seen in sulfonate mutant-inoculated soybean. This makes it likely that, similar to the *B. japonicum ssuD* mutant, this *ssuD* mutant in *S. meliloti* is unable to effectively invade the host plant.

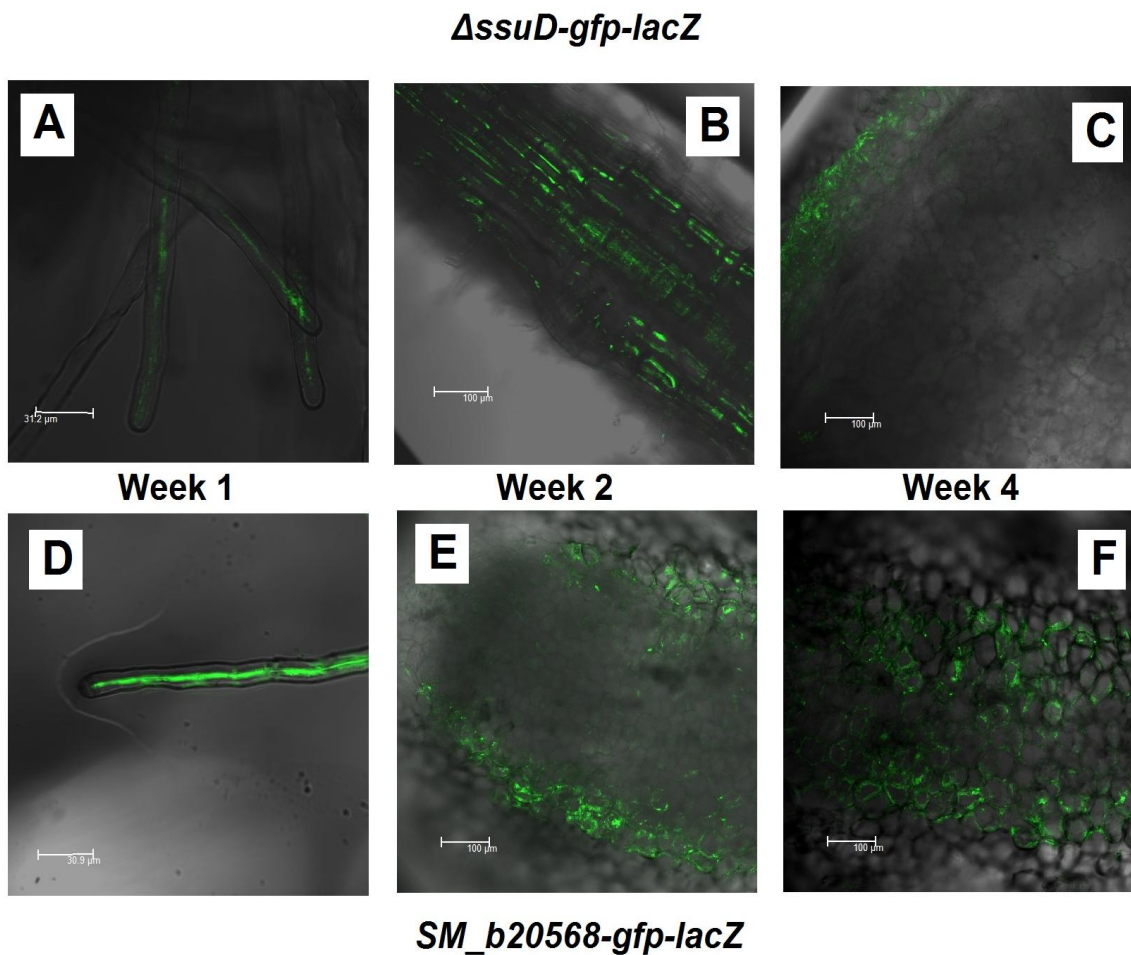

**Figure 51. Nodules from Wild Type and  $\Delta ssuD::gfp-lacZ$  Inoculated Alfalfa**

Plants were harvested four to five weeks after inoculation with wild type and the  $\Delta ssuD::gfp-lacZ$  strain. Alfalfa plants inoculated with wild type displayed the classic indeterminate nodule structure, seen in the elongated nodules. Conversely, the  $\Delta ssuD::gfp-lacZ$  inoculated alfalfa displayed stunted nodules that were round rather than elongated, looking more like determinate nodules.

To determine the cause of underdeveloped nodules in the *ΔssuD::gfp-lacZ* inoculated plants, confocal microscopy was used. Roots and nodules were examined at different time points to determine if there was a defect during the invasion of root hairs or growth once inside of the nodules. Examined alongside the *ΔssuD::gfp-lacZ* was the *SM\_b20568-gfp-lacZ* strain, which showed high expression throughout infection and colonization of nodules acting as a control to compare the *ΔssuD::gfp-lacZ* strain to.

The *ΔssuD::gfp-lacZ* strain showed spotty GFP signal in root hairs and in the symbiotic nodules. Conversely, there was significant GFP signal seen on the exterior of the root (Figure 52). *SM\_b20568-gfp-lacZ* strain provided a stark contrast to the *ΔssuD::gfp-lacZ* strain. The *SM\_b20568-gfp-lacZ* strain showed strong GFP signal throughout the root hairs, as opposed to the spotty expression in the root hairs of *ΔssuD::gfp-lacZ* inoculated plants. This suggests that sulfonates are not utilized during infection or, more likely, the GFP signal is low because the *ΔssuD::gfp-lacZ* strain has reduced viability in the root hair. A distinct contrast was also seen in the nodules. The *ΔssuD::gfp-lacZ* strain displayed very little GFP signal inside of nodule (Figure 52). Once again, this could be due to *ssuD* not being expressed, but it is more likely that few rhizobia are getting in, and the low GFP signal is due to a lack of rhizobia in the nodules. These results make it likely that the sulfonate mutation is both slowing growth within the plant and increasing the sensitivity of *S. meliloti* to oxidative stress.



**Figure 52. Confocal Images of *SM\_b20568-gfp-lacZ* and *ΔssuD::gfp-lacZ* Strains with Alfalfa**

Images were taken of *SM\_b20568-gfp-lacZ* and *ΔssuD::gfp-lacZ*-inoculated alfalfa showing colonization of alfalfa and induction of reporter fusions. A,B and C show *ΔssuD::gfp-lacZ* inoculated alfalfa at weekly intervals. D, E, and F show *SM\_b20568-gfp-lacZ*-inoculated alfalfa at weekly intervals. Scales for the pictures are as follows: A) 31.2  $\mu\text{m}$ , B) 100  $\mu\text{m}$ , C) 100  $\mu\text{m}$ , D) 30.9  $\mu\text{m}$ , E) 100  $\mu\text{m}$ , F) 100  $\mu\text{m}$ .

It is known that during infection thread formation and rhizobia invasion, there is an oxidative burst to protect against unwanted organisms and help form the infection thread (Passardi et al. 2004). To determine if the lack of GFP signal, seen in the infection thread of *ΔssuD::gfp-lacZ*-inoculated alfalfa, was from growth inhibition or lack of *ssuD* expression, the *ΔssuD::gfp-lacZ* strain was tested for expression under oxidative stress. Cultures were grown to mid-log phase in LBMC and then inoculated into minimal medium with different concentrations of H<sub>2</sub>O<sub>2</sub>. At a hydrogen peroxide concentration of 5mM, significant induction of *ssuD* was observed (Figure 52). This result suggests that GFP signal should have been induced in root hairs if *ΔssuD::gfp-lacZ* was present. Thus, it is likely that the lack of GFP signal seen in the *ΔssuD::gfp-lacZ* inoculated plants was from a lack of viability in root hairs due to heightened oxidative sensitivity.

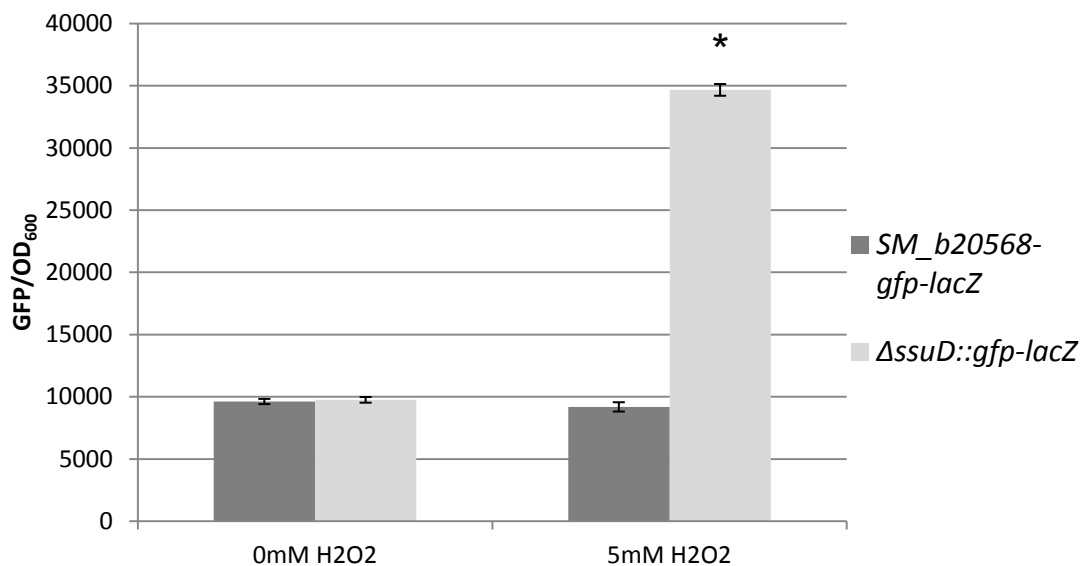

**Figure 53. Induction of *ssuD* in Response to Oxidative Stress**

The *ΔssuD::gfp-lacZ* strain of rhizobia was grown to mid-log phase and inoculated into different concentrations of H<sub>2</sub>O<sub>2</sub>. Induction of *ssuD* was seen in response to oxidative stress. *SM\_b20568-gfp-lacZ* was used as a control.

\*Significance of *ΔssuD::gfp-lacZ* compared with *SM\_b20568-gfp-lacZ* (P-value <0.001).

## Discussion

Nitrogen continues to be the most important nutrient in determining plant growth, leading to nitrogen fertilizer over use and major ecological damage (Ribaudo et al. 2001). The agricultural need for large amounts of nitrogen in a non-ecologically destructive form has led to major investments in biological nitrogen fixation. Subsequently, nitrogen-fixing symbiosis has been studied extensively over the past few decades as the most efficient means for increasing nitrogen inputs sustainably. A third of the world's arable land ( $\approx 400$  million hectares) is completely dependent on forage-legumes for nitrogen inputs (Herridge et al. 2008). In addition to nitrogen derived from forage legumes, there are agriculturally important legumes that contribute to nitrogen inputs, such as soybean (*Glycine max*). *Bradyrhizobium japonicum* USDA110 and *Sinorhizobium meliloti* RM1021 are important nitrogen fixers that have gathered significant attention over the past few decades due to their symbiosis with agriculturally important legumes.

It has become apparent, through the study of nitrogen fixing symbiosis, that rhizobia have a high demand for sulfur when forming nitrogen-fixing symbiotic relationships with plants. However, very little is known about the types of sulfur available for utilization in the plant roots and nodules. The goal of this study was to elucidate the role of organic sulfur in effective nitrogen-fixing symbiosis. This work was carried out in the *Bradyrhizobium japonicum* USDA110 and *Glycine Max L.* model system, and the *Sinorhizobium meliloti* RM1021 and alfalfa (*Medicago*) model system, allowing for a comparison between colonization of determinant and indeterminate nodules.

Sulfate is the preferred sulfur source when culturing bacteria in the lab setting, but this stands in stark contrast to the types of sulfur available to rhizobia in the soil environment. As stated earlier, a majority of the sulfur found in soils is organic in the forms of sulfonates and sulfate esters. When tested on these alternative sulfur compounds, both *B. japonicum* and *S. meliloti* were able to utilize them and even grow better on some of them than on sulfate, as was the case with *B. japonicum* with sulfonates (Figures 11, 12, and 40). Two major differences in sulfur utilization between *S. meliloti* and *B. japonicum* were observed. The first difference was in taurine utilization. *S. meliloti* was similar to the model organism *E. coli* in having *tau* genes, whereas *B. japonicum* was able to utilize taurine, but lacked any gene homologues to *tau* genes. The second difference seen was in arylsulfonate utilization. *B. japonicum* was able to utilize aromatic sulfonates as a sulfur source, unlike *S. meliloti*.

The next question addressed was: under what conditions these alternative sulfur utilization genes were induced. Due to the difficulty of working with *B. japonicum*, most of this work was done in *S. meliloti*. However, induction of sulfonate genes on sulfate, cysteine, alkane sulfonates, and taurine was reported (Sugawara, 2011). When the expression patterns of the sulfur utilization genes in *S. meliloti* were compared with *E. coli*, for which sulfur regulation has been examined extensively, a very similar pattern was observed. Drawing from what is known in *E. coli*, and the strong similarities in expression, it is likely that *S. meliloti* sulfur regulation is indirectly dependent on the internal pool of cysteine. The internal cysteine levels affect the levels of N-acetylserine, which controls the global sulfur regulation genes *cysB* and *cbl*. The one difference,

however, was in taurine utilization. The *tau* genes were not induced by sulfur starvation, but by the presence of their substrate, taurine (Figure 42).

Once regulation of the sulfur genes was determined, expression of the *S. meliloti* sulfur genes was examined in the plant system to identify the types of sulfur utilized during symbiosis. The *tauABC-rfp-gusA* fusion strain was strongly induced during the infection of roots and initial stages of nodule development. However, once the nodules matured, *tau* expression dropped off (Figures 44 and 45). Due to this, it was hypothesized that taurine utilization may be required during root colonization. Several *tau* mutants were tested for their ability to form nitrogen-fixing symbiosis, but no signs of nitrogen deficiency or problems forming nodules were observed. These results suggest that taurine is likely utilized during colonization/infection of roots, but is not vital for the establishing effective symbiosis. The lack of a colonization phenotype in the *tau* mutants may be due to the *ssu* genes providing some redundancy.

The *S. meliloti sbp-rfp-gusA* fusion displayed expression throughout colonization/infection and had localized expression in the mature nodules. Both the X-gluc staining (Figure 44) and confocal microscopy (Figure 45) revealed expression during the colonization of plant roots. These results indicate a sulfur limitation during infection and colonization of nodules. It was also noticed that expression of *sbp* was localized in nodules to zones I and II, where rhizobia are actively infecting newly formed cells. However, once they entered cortical cells and differentiated into bacteroids (zone III), no expression was observed. This suggested that cysteine may be utilized as a sulfur source in the cortical cells.

The observations from the *sbp-rfp-gusA* expression indicated that either no sulfur sources were present during the infection of roots, or that an alternative sulfur source was available, such as alkane sulfonates or taurine. As mentioned earlier, taurine was tested and ruled out as a vital sulfur source, as no colonization defect was found. Additionally, previous work in *B. japonicum* had shown that sulfonate utilization genes were induced in the plant system (Sugawara, 2011). Thus, due to the induction of sulfonate genes in *B. japonicum* and *sbp* in *S. meliloti* when in the plant system, availability of sulfonates in the soil, and the ability of both *B. japonicum* and *S. meliloti* to utilize sulfonates as a sulfur source, it was hypothesized that sulfonate utilization would be an important during the establishment of symbiosis and for viability during symbiosis.

This hypothesis was tested by inoculating host plants with the sulfonate mutants of *B. japonicum* ( $\Delta ssuD::kan$ ) and *S. meliloti* ( $\Delta ssuD::gfp-lacZ$ ). After three weeks of growth, a profound nitrogen deficient phenotype was observed in the plants from both model systems (Figures 14-16, 49). The nitrogen deficient phenotype was corroborated in the *B. japonicum* inoculated soybean, through several tests, ranging from chlorophyll assays (Figure 17) to dry weights (Figure 16), and finally more direct analysis of fixation through acetylene-ethylene assays (Figure 23).

Sulfonate utilization was shown to be required for effective nitrogen-fixing symbiosis. The next question was: in what way sulfonate utilization aids in symbiosis. The sulfonate mutant strains from both model systems developed nodules similar in number to the wild type strains, suggesting that the signaling between the host plants and the rhizobia was unaffected (Figure 18 and 19). In addition to inducing nodule formation, the  $\Delta ssuD::kan$  *B. japonicum* mutant was able to induce root hair curling,

further confirming that the flavonoid/Nod factor signaling is still functional (Figure 27C). However, it was observed that the nodules for both the  $\Delta ssuD::kan$  *B. japonicum* strain and  $\Delta ssuD::gfp-lacZ$  *S. meliloti* strain were smaller and, in the case of *B. japonicum*, had reduced leghemoglobin (Figures 20, 21, 22, and 50).

These results lead to two possible hypotheses as to why the nodules were not growing as large or maturing. The first hypothesis was that the sulfonate mutants from both organisms were defective in root hair entry, resulting in insufficient rhizobia inside to keep the nodules developing. The second was that sulfonate mutants could invade the cortical cells, but growth was arrested in the cortical cells due to an inability to access sulfur.

To examine these hypotheses, the  $\Delta ssuD::kan$  *B. japonicum* cells were tested in competition with the wild type cell for colonization of nodules. The  $\Delta ssuD::kan$  cells showed a greatly reduced ability to colonize the soybean nodules (Figure 27). In addition to the competition study, confocal microscopy of both model systems demonstrated reduced growth within the infection threads of both the  $\Delta ssuD::kan$  *B. japonicum* strain in soybean and the  $\Delta ssuD::gfp-lacZ$  *S. meliloti* strain in alfalfa (Figures 28C and 51). These results point to sulfonate utilization being important for sulfur acquisition during the infection phase. It should be noted that the lack of expression seen in the  $\Delta ssuD::gfp-lacZ$  *S. meliloti* strain could be due to a lack of induction during the invasion of root hairs and the colonization of nodules, but this seems inconsistent with the high induction observed in the *sbp-rfp-gusA* strain during colonization. It is more likely that a mutation in *ssuD* reduced the survivability of *S. meliloti* in root hairs and in the colonizing of

nodules. Also confirming these results was the nitrogen-deficient phenotype of plants inoculated with sulfonate mutants.

The infection thread phenotype seen in sulfonate mutants from both organisms is consistent with the idea that colonizing rhizobia need to acquire sulfur to produce high levels of glutathione for protection from reactive oxygen species released in plant tissues (Passardi et al. 2004; Santos et al. 2001). As discussed earlier, infection thread formation is accompanied by an oxidative burst. This oxidative burst is thought to aid in infection thread formation and prevention of pathogen entry. The  $\Delta ssuD::kan$  *B. japonicum* strain showed more sensitivity to oxidative stress in lab experiments (Figure 29). It was also interesting to note that the  $\Delta ssuD::gfp-lacZ$  *S. meliloti* strain showed induction of *ssuD* in the presence of oxidative stress. This suggests that there may be a yet unknown regulation pathway for *ssu* genes. This also aids in confirming that the lack of GFP signal from the  $\Delta ssuD::gfp-lacZ$  *S. meliloti* strain in root hairs is due to reduced growth and not lack of induction.

While *ssuD* mutants show reduced ability to colonize their host plants, this phenotype does not completely exclude them from the plant nodules. Confocal images for both *S. meliloti* and *B. japonicum* as well as colony counts for *B. japonicum* confirm the presence of *ssuD* mutants in nodules, albeit at greatly reduced numbers compared with the wild type (Figures 24, 25 and 51). This leads to the second hypothesis that the sulfonate utilization mutants are unable to acquire enough sulfur to grow and differentiate once inside nodules. While the  $\Delta ssuD::kan$  *B. japonicum* strain had greatly reduced growth in nodules, it was still able to acquire some sulfur for growth. A slow recovery of the  $\Delta ssuD::kan$  mutant was seen in the nodules of plants that were allowed to mature,

suggesting that while sulfonates are important in symbiosis, they are not the only sulfur source available (Figure 30B).

Sulfate esters were identified as another potentially important sulfur source during symbiosis. Due to over 95% of sulfur in soils being in the form of sulfonates and sulfate esters, it was reasonable to hypothesize that *B. japonicum*, being a soil microbe, would be able to utilize sulfate esters as a sulfur source in nodules.

Preliminary work was done using histochemical staining to identify any sulfatase activity that may be present in the symbiotic nodules. Strong sulfatase activity was seen in the nodules, making it likely that sulfate esters are utilized as a sulfur source during symbiosis (Figure 31). This result makes sense in light of the work done with sulfonates that point to another sulfur source being available in the nodules.

From screening a transposon library, *bll4740* was identified as being involved in sulfatase activity. An insertional mutant was then created in *B. japonicum*,  $\Delta bll4740::kan$  (Figures 32 and 33). It should be noted that disrupting *bll4740* did not abolish all of the sulfatase activity, but greatly reduced it.

Plants inoculated with the  $\Delta bll4740::kan$  mutant displayed a nitrogen deficient phenotype as seen in the chlorosis of the leaves and stunted growth of the plants (Figure 34 and 35). The nitrogen deficient phenotype of  $\Delta bll4740::kan$  inoculated plants was confirmed by taking dry weights and measuring the chlorophyll content (Figure 36 and 37). The strong phenotype seen in the  $\Delta bll4740::kan$  inoculated plants demonstrates that not only are sulfatases expressed in nodules, but they are critical for effective nitrogen fixing-symbiosis.

The final set of experiments with the  $\Delta bll4740::kan$  inoculated plants involved examining the nodule phenotypes. The nodules were found to be smaller than the wild type nodules and took much longer to develop leghemoglobin (Figures 38, 39C, and 39D). Finally, the absence of sulfatase activity in the  $\Delta bll4740::kan$  inoculated plants was confirmed through X-sulfate staining (Figures 38A and 38B).

Similar to what was observed in the  $\Delta ssuD::kan$  *B. japonicum* strain, when the plants were allowed to grow to later stages of maturity, leghemoglobin was able to develop in the nodules. Additionally, sulfatase activity began to show up in the nodules of these matured plants. As noted before, the  $\Delta bll4740::kan$  mutant still had some sulfatase activity likely due to a putative sulfatase gene upstream of *bll4740*. The slow recovery of leghemoglobin and sulfatase activity within nodules suggests that  $\Delta bll4740::kan$  sulfate esters are utilized during symbiosis but are not the only source of sulfur. This shows that a *bll4740* mutation reduces the ability to infect roots through root hairs or slows growth in the nodules. Due to the high sulfur demand for differentiation and growth in nodules, the disruption of *bll4740* appears to reduce the amount of sulfur that is able to be acquired and thus reduce viability.

The phenotypes seen in the sulfate ester utilization mutant  $\Delta bll4740::kan$  reflected the phenotype seen in the sulfonate utilization mutants from *B. japonicum* and *S. meliloti*. This suggests a scarcity of usable sulfur during infection and establishment of symbiosis. This limitation requires that *rhizobia* utilize several forms of organic sulfur to meet their sulfur demands. This study elucidated the types of sulfur available during symbiosis and demonstrated the reliance of both *B. japonicum* and *S. meliloti* on organic sulfur sources during infection and colonization of plant hosts.

Further work should be done to address what, if any, role inorganic sulfur might play in symbiosis. This would be done by disrupting sulfate transport genes. This would aid in determining the scope of sulfur utilization in symbiotic nodules. Additionally, a double mutant of both sulfonate and sulfate ester utilization genes would be important in determining if any other forms of sulfur are available during symbiosis. Finally, the next step in this project would be to determine what physiological changes are occurring in *B. japonicum* and *S. meliloti* under sulfur limitation to impair infection and cause greater sensitivity to reactive oxygen species. This may be due to low glutathione levels as was hypothesized, or there may be another factor, such as membrane differences due to sulfur limitation.

## Chapter III

### ***Dickeya dadantii* 3937, a Soft Rot Causing Phytopathogen, Utilizes a Phenol Dependent Sulfotransferase during Infection of Potato**

#### **Introduction**

*Dickeya dadantii* 3937 is a rod-shape, Gram negative, gammaproteobacterium, which is an opportunistic phytopathogen (formerly known as *Erwinia chrysanthemi* 3937). *D. dadantii* causes disease in many economically important crops such as potato, maize, banana, and pineapple as well as ornamental house plants and a wide range of subtropical and tropical plants. Symptoms of *D. dadantii* infection include soft-rot, necrosis, wilt, and blight. Soft-rot manifests as severe maceration and decay of plant tissue, while wilting is the reduction of turgor pressure caused by water blockages resulting in a loss of rigidity (Agrios, 1997; Perombelon and Kelman, 1980).

*D. dadantii* enters plants through wounds caused by animals, insects, and wind or naturally occurring openings such as stomata and lenticels on plant surfaces. *D. dadantii* is able to survive in a variety of conditions when not infecting plants. It can grow non-infectiously as an epiphyte or endophyte as well as a saprophyte in soils and groundwater. *D. dadantii* can be dispersed through irrigation, insects, nematodes, and microfauna (Beattie and Lindow 1994; Wilson, Hirano et al. 1999).

Effective infection of plants by *D. dadantii* involves the coordinated production and secretion of several virulence factors. Virulence factors are secreted through a type

II secretion system (T2SS) into plant intercellular spaces. The major virulence factors produced are extracellular enzymes such as proteases, cellulases, and pectate lyase protease (Hugouvieux-Cotte-Pattat, Condemine et al. 1996; Matsumoto, Muroi et al. 2003). These enzymes are used to degrade the plant cell walls. This degradation loosens the tight cell wall structure enough to allow the type three secretion system (T3SS) to form through the loosened structure (Jha et al. 2007; Gohre and Robatzek, 2008).

During infection, *D. dadantii* must evade both basal and systemic immune responses, which involves avoiding detection. Plants are able to detect specific antigens present on the surface of pathogens called pathogen-associated molecular patterns (PAMPs). When plants detect these PAMPs, through pattern recognition receptors (PRRs), a signaling cascade is initiated that results in the PAMP-triggered immune response (Schwessinger and Zipfel, 2008).

To prevent detection, *D. dadantii* produces effector molecules that interfere with the plant PAMPs signal cascade by mimicking eukaryotic enzymes, thus preventing initiation of an immune response and causing effector-triggered susceptibility. These effector molecules are injected directly into plant cells by the T3SS (Dubery et al. 2012).

To counter effector molecules, injected into the cytoplasm of plant cells by the T3SS, plants produce R (Resistance) proteins that have evolved to recognize effector molecules or their actions. These R proteins are polymorphic NB-LRR proteins. These proteins, NB-LRR, are named after their nucleotide binding domain (NB) and leucine-rich repeat domain (LRR) (Jones and Dangl, 2006). When these NB-LRR proteins identify effector molecules, they initiate effector-triggered immunity, which causes a hypersensitive cell death response (Figure 54).

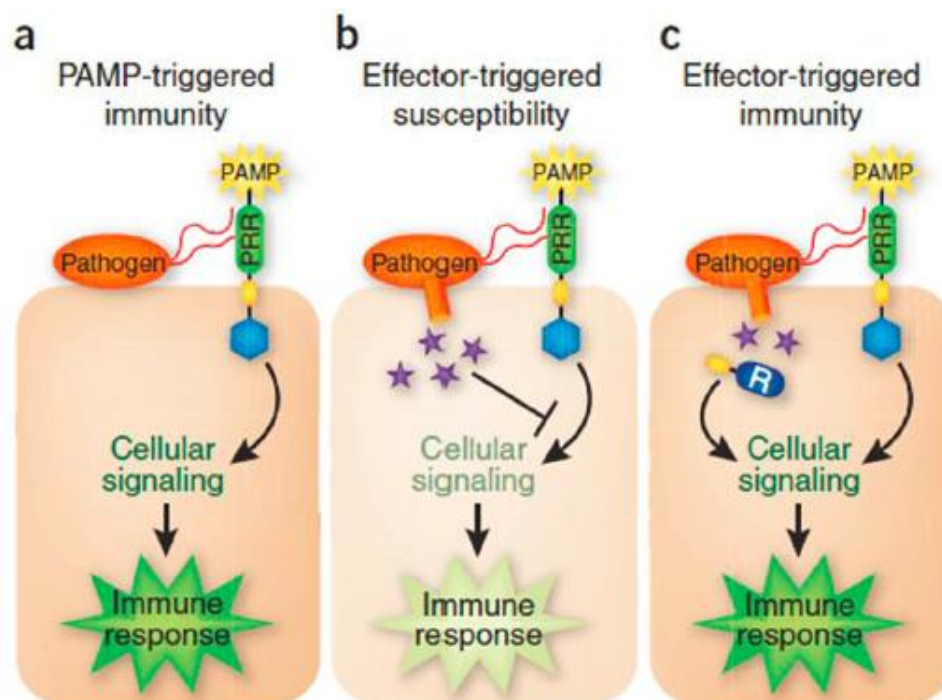

**Figure 54. Plant Immune Response**

In step A, plants detect pathogen-associated molecular patterns (PAMPs) with pattern recognition receptors (PRRs) and activate PAMPs-triggered immunity. In Step B, pathogens inject effector molecules that interfere with PAMPs-triggered immunity and enable full infection and effector-triggered susceptibility. In step C, an effector is recognized by an NB-LRR protein (R protein) and effector-triggered immunity is activated (Pieterse et al. 2009)

Plant hormones play a key role as cellular signaling molecules that regulate immunity to phytopathogenic bacteria (Pieterse et al. 2012). Of these hormones, salicylic acid and jasmonic acid have been identified as major plant defense hormones. There are additional modulators of the plant immune system such as ethylene, abscisic acid, gibberellins, auxins, cytokinins, brassinosteroids, and nitric oxide, of which salicylic acid and jasmonic acid play the primary role (Browse 2009, Vlot et al. 2009).

Of particular interest to this study is salicylic acid, due to its phenolic structure and role in the plant immune response. The salicylic acid immunity pathway is most effective against microbial pathogens (Glazebrook, 2005). Salicylic acid biosynthesis occurs during PAMP- triggered immunity and effector- triggered immunity once PAMPs or effector molecules are identified and  $\text{Ca}^{+2}$  spiking occurs (Mishina and Zeier, 2007). Salicylic acid is then able to upregulate a large set of defense related genes (Moore et al. 2011).

Plant hormones involved in defense signaling have been shown to be targeted by phytopathogenic bacteria to subvert the host immune response (López et al. 2008). Disruption of hormone immune function by pathogens is accomplished by producing plant hormones, hormone mimics, or effectors that target hormone signaling components (Robert-Seilaniantz et al. 2011).

*D. dadantii* has been used as a model organism for studying bacterial induced disease in plants. The focus of most studies has been the secretion systems and virulence factors in an attempt to find targets for disease prevention. However, one area that has not been explored in *D. dadantii* is sulfur metabolism and its role in infection. The only aspect of sulfur understood is in the acquisition of iron through Fe-S centers. This study looked at sulfur metabolism and the role it plays in the pathogenicity of *D. dadantii*.

## Methods and Materials

### *Bacterial Strains and Growth Conditions*

The strains, plasmids, and DNA primers used in this study are listed in Table 3. *D. dadantii* was grown between 28°C and 30°C at 200 rpm in LB (Luria-Bertani) broth. For testing growth on different sulfur sources, N<sup>-</sup>S<sup>-</sup>C<sup>-</sup> was used. N<sup>-</sup>S<sup>-</sup>C<sup>-</sup> contains the following (per liter): 17.7g K<sub>2</sub>HPO<sub>4</sub>, 4.7g KH<sub>2</sub>PO<sub>4</sub>, 2.5g NaCl, and 0.1g MgCl<sub>2</sub>. When inoculating strains for growth, 10mM glucose, 10mM NH<sub>4</sub>Cl, 1mM MgCl, and 1mM of sulfur sources to be tested were added. Antibiotic concentrations used were as follows; 50µM kanamycin, 10µM tetracycline, and 100µM ampicillin. Growth conditions and antibiotic concentrations for *E. coli* were the same as discussed previously.

Table 2. *Strains, Plasmids, and Primers used in this Study*

<b>Strain</b>	<b>Description</b>	<b>Source</b>
<i>Dickeya dadantii</i> 3937	Wild type strain, <i>Saintpaulia</i> isolate	Ching-Hong Yang Lab (UWM)
<i>Dickeya dadantii</i> 3937 <i>P<sub>ssuE</sub>-GFP</i>	3937 strain carrying pPROBE-AT with <i>ssu</i> operon promoter fused to promoter-less GFP	This Study
<i>Dickeya dadantii</i> 3937 <i>P<sub>cysGI</sub>-GFP</i>	3937 strain carrying pPROBE-AT with <i>cys</i> operon promoter fused to promoter-less GFP	This Study
<i>Dickeya dadantii</i> 3937 <i>P<sub>sbp</sub>-GFP</i>	3937 strain carrying pPROBE-AT with <i>sbp</i> operon promoter fused to promoter-less GFP	This Study
<i>Dickeya dadantii</i> 3937 <i>P<sub>atsB</sub>-GFP</i>	3937 strain carrying pPROBE-AT with <i>ats</i> operon promoter fused to promoter-less GFP	This Study
<i>Dickeya dadantii</i> 3937 <i>Δssu::kan</i> operon	3937 strain with insertional deletion of <i>ssu</i> operon with kan <sup>R</sup> cassette	This Study
<i>Dickeya dadantii</i> 3937 <i>Δcys::kan</i> operon	3937 strain with insertional deletion of <i>cys</i> operon with kan <sup>R</sup> cassette	This Study
<i>Dickeya dadantii</i> 3937 <i>Δats::kan</i> operon	3937 strain with insertional deletion of <i>ats</i> operon with kan <sup>R</sup> cassette	This Study
<i>E. coli</i> DH5α	General cloning host	Lab Stock
<b>Plasmids</b>	<b>Description</b>	<b>Source</b>
pPROBE-AT	Long-life promoter probe GFP expressing vector, Amp <sup>R</sup>	Miller et al. 2000
pGEM-T Easy	Amp <sup>R</sup> General cloning vector with Kan <sup>R</sup> casett	Promaga
pUC18	Amp <sup>R</sup> General cloning vector	Lab Stock
pWM91	Amp <sup>R</sup> suicide vector	Lab Stock

<b>Primer</b>	<b>Sequence 5' to 3'</b>	<b>Source</b>
<i>ats</i> H1 F	GCTCCAGCCTACACAACCATCATCTGCCGCACACC	This Study
<i>ats</i> H1 R	TTGCGCTTAGCCCACCACTC	This Study
<i>atsB</i> H2 F	AAACTAGCGAACGCGACCGT	This Study
<i>atsB</i> H2 R	GAGGATATTCATATGCAGAATTTGCGGCGGCATCC	This Study
<i>ats</i> promoter F	CATAAGCTTCGCCACATCCAAGTCTGGT	This Study
<i>ats</i> promoter R	GTCATGAATTCGACCAGCTATCCGGCATCGG	This Study
<i>cysA</i> H1 F	GCTCCAGCCTACACAGGATATCCGTCCGTTGGGCG	This Study
<i>cysA</i> H1 R	CTGCTGGTCACCATGGGCAA	This Study
<i>sbp</i> H2 F	TCGGCTGCCACGGAATTGTT	This Study
<i>sbp</i> H2 R	GAGGATATTCATATGTGCTGTTATCCGGCAGACGC	This Study
<i>sbp</i> promoter F	CATAAGCTTGGCTGGCAGGCTAACGAACT	This Study
<i>sbp</i> promoter R	GTCATGAATTCACCGGAACAGCGGCTAAACAG	This Study
<i>cysC</i> H1 F	GCTCCAGCCTACACAGATGGTCGATGCCGGTCTGG	This Study
<i>cysC</i> H1 R	GGCAGCGAGACAAAACACGC	This Study
<i>cysD</i> H2 F	CCCGCTGCTGCATGTGGATA	This Study
<i>cysD</i> H2 R	GAGGATATTCATATGAGCTCCGGGCGCTGATTTTT	This Study
<i>cysD</i> promoter F	CATAAGCTTTTCGGCCTGAAACGCGAATGT	This Study
<i>cysD</i> promoter R	GTCATGAATTCGCTTAATAACGGTTTTTCATGACGG	This Study
<i>ssuE</i> H1 F	CTAAAAGGGCGAGGCCCAGG	This Study
<i>ssuE</i> H1 R	GCTCCAGCCTACACAGCGAGTTGCTCGTTCAGGGT	This Study
<i>ssuB</i> H2 F	GAGGATATTCATATGGATCGAAGAAG	This Study
<i>ssuB</i> H2 R	GCCGGGTCCGGGGCGTAGGCACAATCCAA	This Study
<i>ssu</i> promoter F	CATAAGCTTGGTTACAAACCGGGGGCGTATT	This Study
<i>ssu</i> promoter R	GTCATGAATTCOAAGTTGCAGATGCGTTGGC	This Study
kan cassette F	TGTGTAGGCTGGAGCTGCTTC	Hutchins, 2013
Kan cassette R	CATATGAATATCCTCCTTAGTTCCTATTCC	Hutchins, 2013

### *Construction of Promoter-GFP Reporter Fusions*

Construction of the promoter-GFP reporter fusions was done by amplifying a 500bp region upstream of the gene of interest with primers containing EcoRI and HindIII restriction sites. PCR products and the target vector pPROBE-AT were double digested with EcoRI and HindIII. Digested PCR products were ethanol precipitated. After digestion was confirmed, the digested vector, pPROBE-AT, was isolated from an agarose gel using a GE Healthcare gel band purification kit. Digested PCR and vector were ligated together in a three to one ratio, respectively.

Ligations products were transformed into DH5 $\alpha$  and selected on LB media containing ampicillin. Promoter insertions were confirmed using PCR. Constructs were then isolated from DH5 $\alpha$  using a Promega PureYield plasmid isolation kit. Isolated constructs were confirmed through sequencing then electroporated into the wild type *D. dadantii* 3739 strain and selected on LB ampicillin plates.

### *Construction of Operon Mutants*

Sulfur operon mutants were constructed by amplifying 200bp to 400bp regions at the beginning and end of the operon. The internal primers contained regions that overlap with a kanamycin cassette, allowing for an overlap PCR to be performed. The overlap PCRs were run on a gel and isolated using a GE Healthcare gel band purification kit. Purified overlap PCRs were blunt end ligated into pWM91 and transformed into DH5 $\alpha$ . Selection was done on LB with kanamycin. Constructs were then isolated from DH5 $\alpha$  using a Promega PureYield plasmid isolation kit. They were then electroporated into

wild type *D. dadantii* and selected on LB with kanamycin. Confirmation of the operon deletions was done by PCR.

### *Operon Expression Assays*

Cultures were grown overnight in 5mL of LB broth, cells were spun down washed with N<sup>-</sup>S<sup>-</sup>C<sup>-</sup>, and resuspended in 5mL of N<sup>-</sup>S<sup>-</sup>C<sup>-</sup>. One mL of culture was then added to N<sup>-</sup>S<sup>-</sup>C<sup>-</sup> growth media with appropriate nitrogen, carbon and sulfur source being tested. Cultures were induced on sole sulfur sources overnight. OD<sub>600</sub> readings were taken on the overnight cultures. Cultures were then spun down, washed, and resuspended to normalize the concentration of cells in N<sup>-</sup>S<sup>-</sup>C<sup>-</sup> using the OD<sub>600</sub> readings. 200µL of resuspended culture was put onto a Corning 96 well, clear bottom, black plate for GFP measurements. Measurements were taken in an Infinite 200Pro Micro Plate Reader. GFP readings were done at 395nm excitation and 509nm emission. Readings were then converted into GFP per OD<sub>600</sub>

### *Potato Infection Assay*

Potatoes were washed using detergent and then surface sterilized using 70% ethanol. Potatoes were then cut in half and a 2.0 cm hole was made in the center of the potato slice using a sterile 200µL pipette. *D. dadantii* cultures were grown overnight and OD<sub>600</sub> readings were taken. Cultures were spun down, washed and resuspended to an OD<sub>600</sub> of 0.6. 10µL of culture were then inoculated into the hole made in each potato

slice. Potatoes were incubated at 28°C in magenta boxes. Sterile damp paper towels were added to the bottom of the magenta boxes to moderate the humidity. Potato slices were examined for symptoms of soft rot two days after inoculation.

### *Potassium 4-Nitrophenyl Sulfate (PNPS) Assay*

*D.dadantii* cells were grown overnight washed and inoculated into 5mL of appropriate media for induction. Cultures were induced overnight before performing the assay. OD<sub>600</sub> readings were taken on the overnight-induced cultures. Between 200µL and 900µL of cells were added to test tubes and diluted with N<sup>-</sup>S<sup>-</sup>C<sup>-</sup> to an OD<sub>600</sub> of 0.8. Cells were then permeabilized with 10µL of chloroform by vortexing and incubating at 30°C for 10min. Phenolic compound for phenol dependent sulfotransferase was then added and incubated for an additional 20min. 100µ of 50mM PNPS was added, tubes were vortexed and incubated in a 30°C water bath until a yellow color developed. The reaction was then quenched with 2mL of 2M NaOH. Absorbance readings were taken in a 96 well plate at 420nm and 550nm for the Miller unit calculations.

## Results

### *Sulfur Utilization in Dickeya dadantii 3937*

The first aspect of sulfur metabolism explored in *Dickeya dadantii* was sulfur source utilization. Several different sulfur sources were evaluated to determine if they could be utilized by *D. dadantii* and how effectively they were utilized. *D. dadantii* was able to utilize both organic and inorganic forms of sulfur. It grew on sulfonates (HEPES), taurine, cysteine, and sulfate to a similar final O.D.<sub>600</sub>. However, growth on cysteine was slow compared to the other sulfur sources. Finally, it was apparent that *D. dadantii* is unable to utilize aromatic sulfonates as seen by the lack of growth on benzene sulfonate (Figure 55).

After determining the range of sulfur utilization of *D. dadantii*, the genome was searched for putative sulfur utilization genes. Several sulfur utilization operons were identified including sulfate transport, sulfate reduction, sulfonate transport/utilization, and sulfotransferase utilization (Figure 56). To examine the regulation of sulfur metabolism in *D. dadantii* these putative sulfur utilization operons were then studied by constructing GFP promoter fusions in pPROBE AT. No taurine utilization genes were found in *D. dadantii*, making it likely that the sulfonate sulfur utilization genes are able to utilize all sulfonates, including taurine.

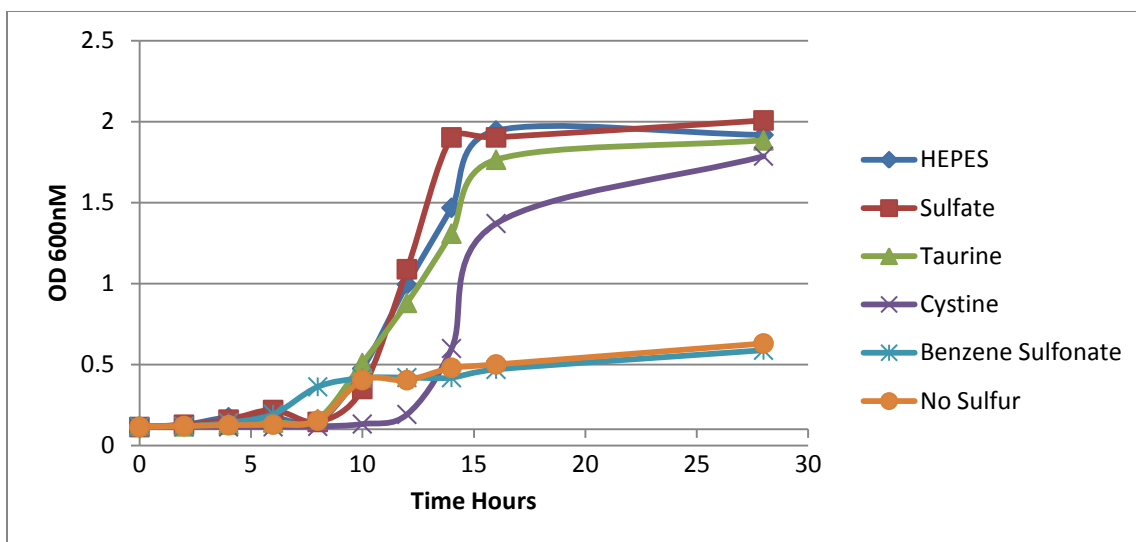

**Figure 55. Growth Curves of *D. dadantii* in Different Sulfur Sources**

Cultures were inoculated into minimal media containing 10nM carbon source, 10mM nitrogen source, and 1mM sulfur source. *D. dadantii* was able to grow well on sulfate, sulfonates, taurine, and to a lesser degree cysteine. No growth was seen on aromatic sulfonates.

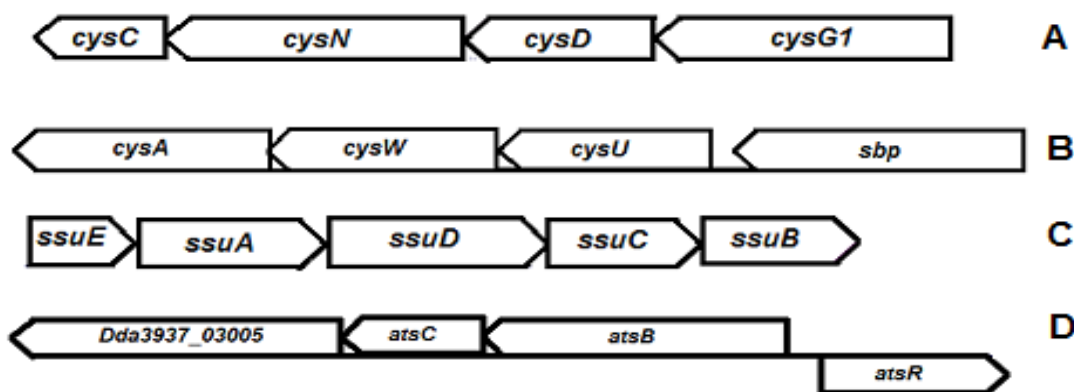
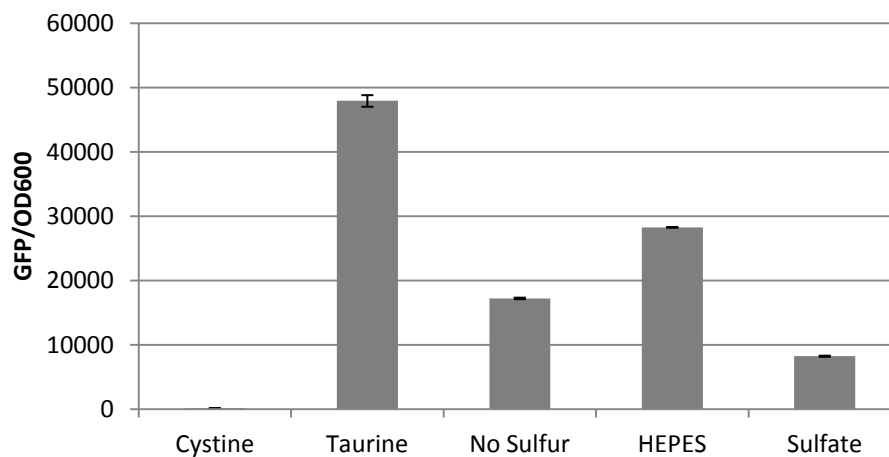

**Figure 56. Sulfur Utilization Genes**

Putative sulfur utilization genes identified in *D. dadantii*. Operon A genes convert sulfate to APS, to PAPS, and finally sulfite. Operon B defines a sulfate ABC transporter and sulfate binding protein. Operon C specifies an ABC transporter for sulfonates, as well as a monooxygenase to convert sulfonate to sulfite. Operon D specifies alkane sulfonate transport genes and a phenol-dependent sulfotransferase gene.

## *Expression of Sulfur Genes in Response to Sulfur Conditions*

In order to examine the expression of sulfate, sulfonate, and sulfotransferase genes, promoters from these sulfur utilization operons were ligated into pPROBE AT and transformed into *D. dadantii*. The highest expression was seen from the promoter for the sulfate binding protein (*sbp*) operon. Expression of the *sbp* operon followed the same pattern seen in the model organism, *E. coli*. Expression of *sbp* in *D. dadantii*, similar to *E. coli*, was repressed when grown with cystine due to the cystine simulating sulfur excess conditions (Figure 57). In contrast, the *sbp* operon was highly expressed under sulfur-limiting conditions. Finally, when sulfate was available, the *sbp* operon showed moderate levels of expression, likely due to the efficient production of cysteine and thus a feedback loop that limits the amount of sulfur uptake (Figure 57) (Aguilar-Barajas 2011). Due to the similarity to *E. coli* of the *sbp* expression pattern, it is likely to be regulated indirectly by the internal pools of cysteine.



**Figure 57. Expression of the *sbp* Operon in Different Sulfur Sources**

Cultures were grown on LB to mid log phase, washed, and inoculated into minimal media containing different sulfur source. The sulfate binding protein operon showed a similar expression pattern to what is known in *E.coli*. The *sbp* operon appears to be regulated by internal sulfur pools.

\*The variance of the induction on different sulfur sources proved to be significant (P-value <0.001).

In addition to looking at the regulation of sulfate transport genes, induction of sulfate reduction genes was also examined. The promoter for the *cysGDNC* operon was ligated into pPROBE AT to create a  $P_{cysGI}$ -GFP *D. dadantii* strain. The expression of this operon was significantly lower than that of the induced *sbp* operon, and the expression pattern was quite different. This operon was only slightly affected by the internal levels of cysteine. The expression of this operon seemed to be opposite of the sulfate transport genes, showing higher expression when internal cysteine levels were also high (Figure 58). This expression pattern seemed counter-intuitive. However, the different expression pattern is likely due to *cysG* (siroheme synthase) playing a role in the production of B<sub>12</sub>. B<sub>12</sub> plays a role in the conversion of homocysteine to methionine, and would be needed when the pools of internal cysteine are high (Spencer et al. 1993; Selhub, 1999).

The *ssu* operon showed the highest expression under sulfur limiting conditions. This is similar to what is seen in *E. coli ssu* expression. When grown on sulfonates, the expression was about 25% of the “no sulfur” conditions, suggesting that the regulation of this operon is also similar to *E. coli* in that it has to do with internal cysteine levels and not the presence of sulfonates (Figure 59). *D. dadantii* contains both *cbl* and *cysB*, which have been shown to be global regulators of alternative sulfur utilization in *E. coli* (van der Ploeg et al. 2001). The presence of these global regulators in the genome and the similarities in expression patterns to *E. coli* make it likely that sulfur metabolism is regulated in a similar fashion in *D. dadantii*.

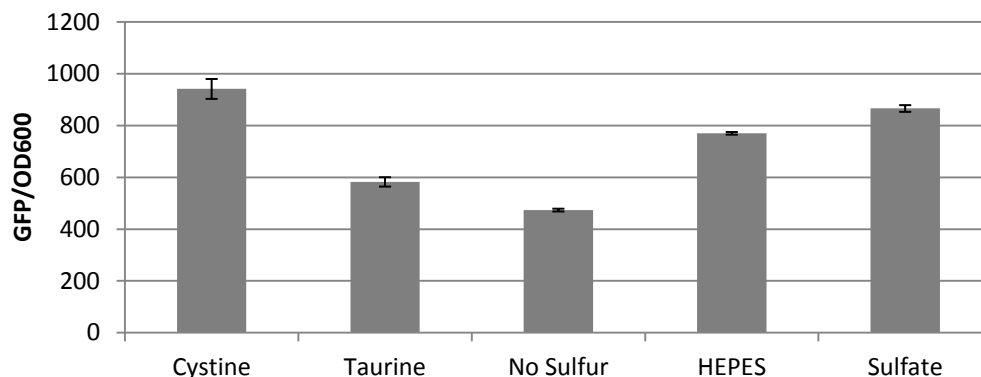
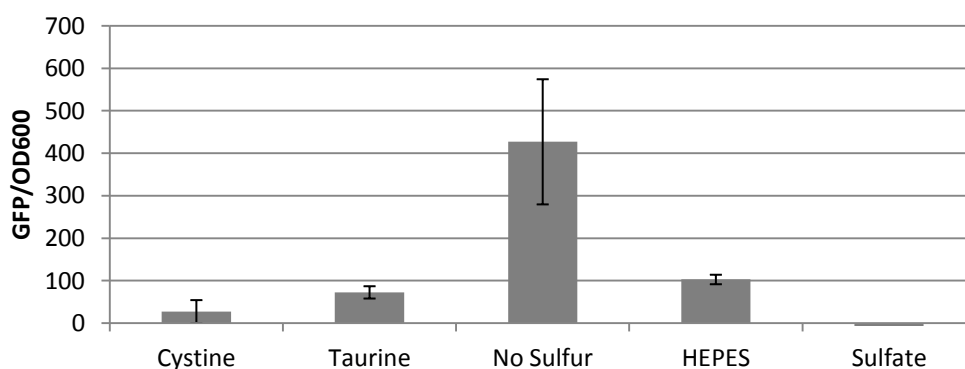

**Figure 58. Expression of *cysGDNC* Operon Promoter in Different Sulfur Sources**

*D. dadantii*  $P_{cysG1}$ -GFP strain was grown in LB to mid log phase, washed and inoculated into minimal media containing different sulfur sources. Expression was read in a 96 well plate reader after overnight induction. Induction was expressed in GFP/OD<sub>600</sub>.

Expression was seen on all sulfur sources, with the highest being on cystine and sulfate.

\*The variance of the induction on different sulfur sources proved to be significant (P-value =0.006).

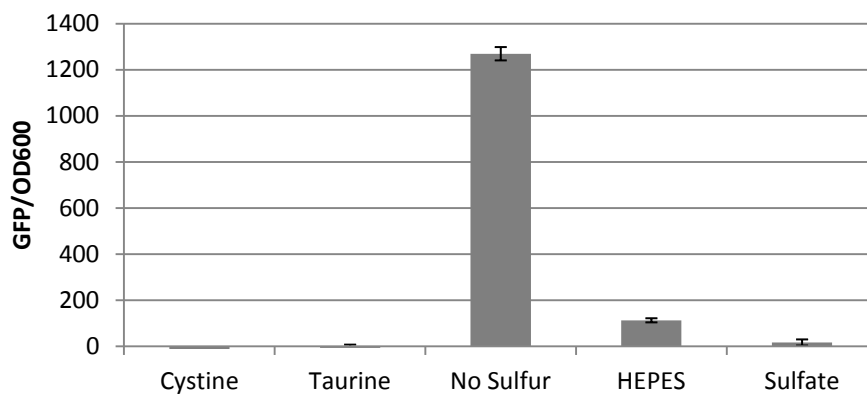

**Figure 59. Induction of *ssu* Operon in Different Sulfur Sources**

The  $P_{ssuE}$ -GFP *D. dadantii* strain was grown in LB to mid log phase, washed, inoculated into minimal media containing different sulfur sources, and induced overnight. Induction was expressed in GFP/OD<sub>600</sub>. High induction was seen under sulfur limiting conditions.

\*The variance of the induction on different sulfur sources proved to be significant (P-value =0.005).

The final sulfur utilization operon examined was the *ats* operon. This operon is interesting in that it also contains a phenol-dependent sulfotransferase, which transfers sulfates to phenolic compounds. Conversely, the arylsulfatase genes in the operon remove sulfate from phenolic compounds. Having these opposing reactions in the same operon makes this an interesting operon. The operon did respond to sulfur limiting conditions showing high induction (Figure 60). This suggests that that these genes are regulated similar to the *ssu* genes. Which is interesting since *D.dadantii* was unable to grow in arylsulfonates. Due to sulfotransferases frequently interacting with hormones, it was thought that these genes may play a role in disrupting host immunity during infection.



**Figure 60. Induction of *ats* Operon in Different Sulfur Sources**

The  $P_{atsB}$ -GFP *D. dadantii* strain was grown in LB to mid log phase, washed, inoculated into minimal media containing different sulfur sources, and induced overnight. Induction was expressed in GFP/OD<sub>600</sub>. The *ats* operon showed highest expression under sulfur limited conditions.

\*The variance of the induction on different sulfur sources proved to be significant (P-value <0.001).

## *Sulfotransferases are Required for Infection of Potato*

To examine the types of sulfur utilized during infection of host plants, the following mutants were made:  $\Delta ssuEABCD::kan$ ,  $\Delta cysGDNC::kan$  and  $\Delta ats::kan$  operon. The  $\Delta ssuEABCD::kan$  strain was unable to utilize alkane sulfonates or taurine, confirming the hypothesis that taurine is utilized through the *ssu* operon (Figure 61). This also confirms the role of the *ssu* operon in sulfonate utilization. Due to *D. dadantii* utilizing taurine less efficiently through the *ssu* pathway, it is logical that *D. dadantii* did grow as well on taurine as on sulfonates.

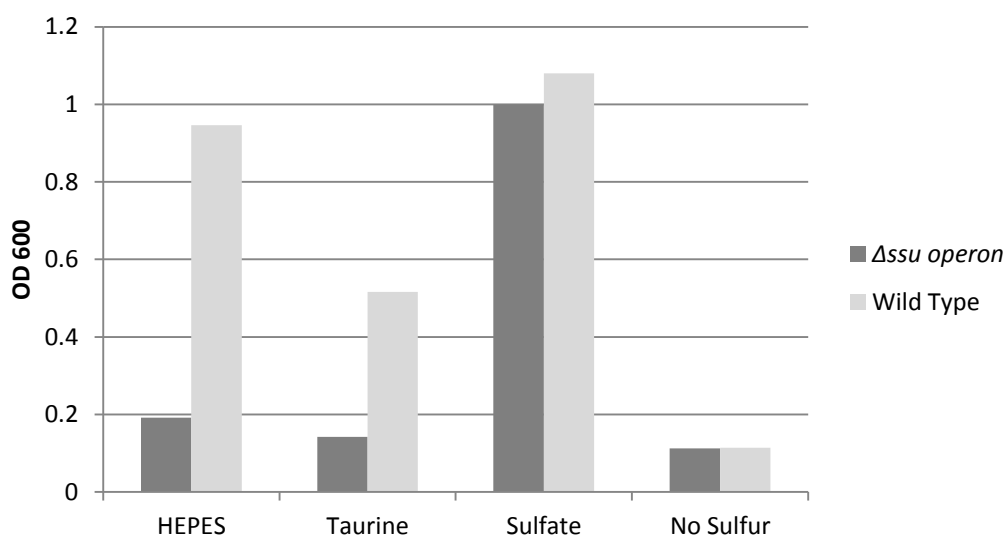
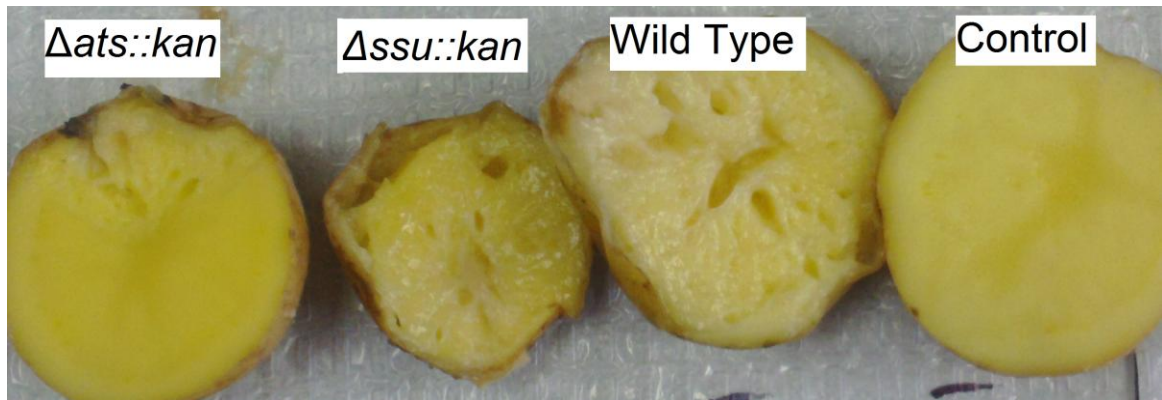

**Figure 61. Growth of  $\Delta ssu::kan$  vs. Wild Type in Different Sulfur Sources**

The  $\Delta ssuEABCD::kan$  strain was sulfur starved in minimal media overnight before inoculating into minimal media with 1mM of sulfur source. The lack of growth of the  $\Delta ssuEABCD::kan$  strain indicates that the operon is responsible for the utilization of both alkane sulfonates and taurine as a sulfur source.

The constructed mutant strains *ΔssuEABCD::kan* and *Δats::kan* were inoculated onto potato and Chinese cabbage to examine for infection phenotypes. No infection phenotypes were observed with either strain when inoculated on cabbage. Surprisingly, the *ΔssuEABCD::kan* strain did not have a phenotype infecting potato, either. It had been hypothesized that there would be deficiencies in the *ΔssuEABCD::kan* strain infection, due to sulfonates playing such an important role in rhizobial infection of plant roots. This points to significant differences in sulfur utilization and acquisition between pathogenic infection and symbiotic colonization of plant tissues.

Interestingly, the *Δats::kan* strain had an infection phenotype (Figure 62A). The soft rot caused by *D. dadantii* in potato, observed as maceration of the potato, was greatly slowed in the *Δats::kan* strain (Figure 62). Infection of potatoes inoculated with the *Δats::kan* strain progressed much slower than the wild type strain (Figure 62A,) and in some instances, infection was halted altogether (Figure 62B). As shown earlier, *D. dadantii* was unable to grow on arylsulfonates; thus, these genes are not were not involved in sulfur metabolism. This makes it likely that these sulfur related genes are being used as effector molecules or virulence factors during infection to sulfonate and desulfonate plant hormones during infection.



A

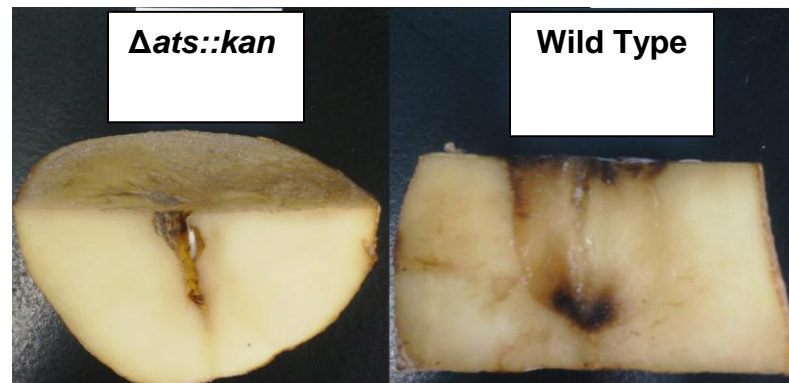

B

**Figure 62. Infection of Potato by Wild Type and Mutant Strains of *D. dadantii***

Cultures were grown to mid log phase and washed before inoculation. 2cm holes were made in the potato slices with a 200 $\mu$ L pipette and 10 $\mu$ L of cultures were inoculated into the potato. (A) Shows the infection of potato by the  $\Delta$ *ats::kan* operon strain,  $\Delta$ *ssuEABCD::kan* strain, and wild type strain of *D. dadantii*. The  $\Delta$ *ats::kan* operon mutant shows slowed infection compared to the wild type. (B) Shows an attenuation of the  $\Delta$ *ats::kan* infection, while the wild type macerates the potato.

To further examine the role of the *ats* operon during infection of potato, the sulfotransferase enzymatic activity was characterized using a potassium 4-nitrophenyl sulfate (PNPS) assay. When sulfate is removed from the PNPS compound, it produces a yellow color that can be used to quantify the sulfotransferase activity in Miller units. To characterize the predicted phenol dependence of the sulfotransferase, the PNPS assay was run with different concentrations of phenol. The results demonstrate that sulfate was only removed from PNPS when phenol was present (Figure 62). Under low or no phenol conditions, no removal of sulfate from PNPS was observed. This confirmed that the sulfotransferase produced by the *ats* operon requires the presence of phenolic compounds for activity.

To confirm the mutation in the *ats* operon, another PNPS assay was run comparing the  $\Delta ats::kan$  mutant to the wild type strain. This experiment confirmed that the  $\Delta ats::kan$  mutant lacked any sulfotransferase activity and that these genes were responsible for the sulfotransferase activity (Figure 64). Based on these results, the enzyme produced by the *ats* operon is a phenol dependent sulfotransferase that is important for effective infection of potato. These results coupled with the induction experiments seem to indicate that sulfur limitation may induce this effector molecule for infection.

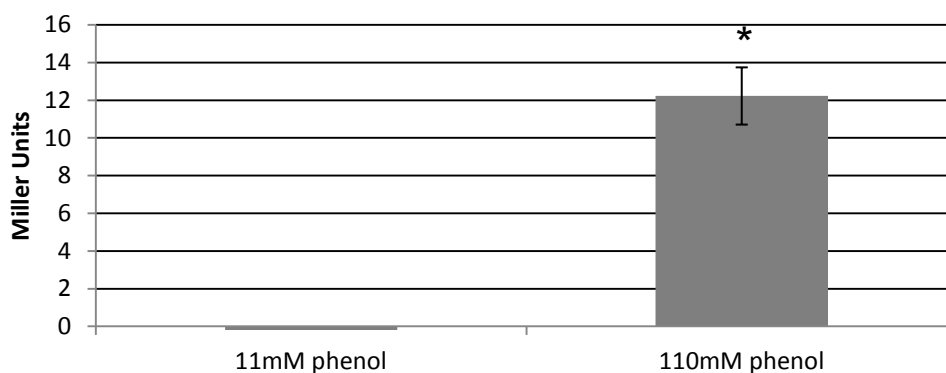

**Figure 63. Phenol Dependent Sulfotransferase Activity in Different Concentrations of Phenol**

*D. dadantii* was assayed for phenol-dependent sulfotransferase activity with different concentrations of phenol. At a phenol concentration of 110mM, sulfotransferase activity was observed, indicating that phenol is required for activity. Lower concentrations of phenol were also tested, but results are not shown.

\*Significance of sulfotransferase activity on 11mM phenol compared to 110mM phenol (P-value <0.001).

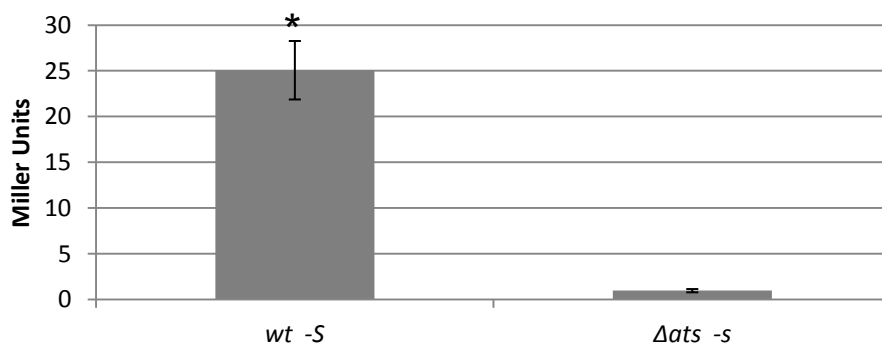

**Figure 64. Activity of Phenol Dependent Sulfotransferase Under Sulfur Limited Conditions**

Cultures were grown in sulfur limited conditions overnight before performing the PNPS assay to identify sulfotransferase activity. The  $\Delta$ ats::kan mutant showed no sulfotransferase activity, while the wild type showed induction of activity under sulfur limited conditions.

\*Significance of sulfotransferase activity of the  $\Delta$ ats::kan compared with the wild type (P-value =0.009).

The final question examined was what this phenol-dependent sulfotransferase could target to aid in the infection of potato. It was hypothesized that it would target the salicylic acid-induced immunity pathway. Salicylic acid is a phenolic compound making it possible that this phenol-dependent sulfotransferase could disrupt salicylic acid signaling by transferring sulfates onto it.

To examine the possibility of this enzyme interacting with salicylic acid, wild type *D. dadantii* was inoculated into MG + potato infusion media containing X-SO<sub>4</sub>, with one of the following conditions: phenol added, salicylic acid added, or no phenolic compounds added. The wild type strain was only able to transfer the sulfate from X-SO<sub>4</sub> when phenol or salicylic acid was present (Figure 65). This demonstrates that the phenol dependent sulfotransferase is able to use salicylic acid for sulfotransferase. This makes it plausible that this enzyme is involved in preventing a salicylic acid immune response. Several experiments were done in an attempt to quantify the sulfotransferase activity with salicylic acid, but the activity was too low to get adequate readings.

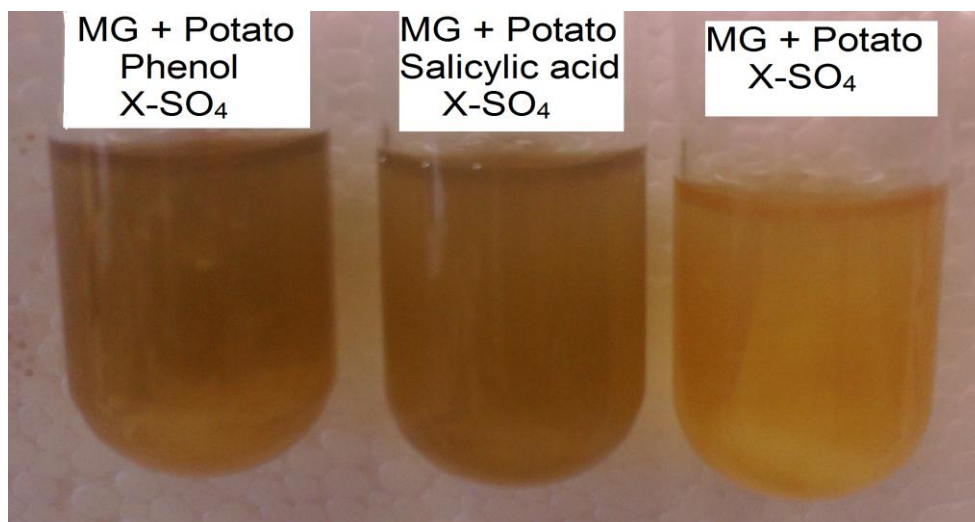

**Figure 65. Utilization of Salicylic Acid by Phenol-Dependent Sulfotransferase**

Wild type *D. dadantii* was inoculated with MG + potato infusion with phenol, salicylic acid, or no phenolic compound was tested for phenol-dependent sulfotransferase activity. It was demonstrated that salicylic acid could be utilized for the sulfotransferase activity.

## Discussion

This study took a first look into the importance of sulfur metabolism in the pathogenicity of *Dickeya dadantii*. Most studies of *D. dadantii* have been focused on virulence factors, effector molecules, and secretion systems (Hugouvieux-Cotte-Pattat, Condemine et al. 1996; Matsumoto, Muroi et al. 2003). However, the basic components of metabolism may prove to be useful in better understanding how infection progresses.

*D. dadantii* was able to utilize both inorganic and organic sulfur as sole sources of sulfur. *D. dadantii* was able to grow equally well on alkane sulfonates and sulfate as well as utilize taurine and cysteine at slightly slower rates (Figure 40). Additionally, several sulfur utilization genes were identified that showed homology to sulfur genes in *E. coli*. The expression of these sulfur genes was examined using promoter fusions in pPROBE-AT. Interestingly, *D. dadantii* was not shown to have any taurine utilization genes, but was still able to grow on taurine, presumably utilizing it through the *ssu* pathway (Figure 55). The expression pattern seen for sulfate utilization, cysteine biosynthesis and sulfonate sulfur utilization were all the same to the expression of sulfur genes in *E. coli* (Figures 57-60). This makes it likely that the regulation of sulfur metabolism is similar to that of *E. coli*, in which internal levels of cysteine indirectly regulate sulfur utilization genes along with Cbl and CysB, as explained earlier (van der Ploeg et al. 2001).

The ability of *D. dadantii* to cause soft rot in host plants has been shown to be dependent on multiple factors (Charkowski et al. 2012). The T2SS secretes enzymes into the external environment causing maceration and tissue damage. Concurrently, the T3SS acts to subvert the host cell's immunity by injecting effector molecules into the cytosol of

the plant. Several sulfur utilization mutants were inoculated on potato to determine the role of sulfur in the virulence of *D. dadantii*. It was surprising to see that the sulfonate operon mutant had no defect during the infection of potato. Sulfonate utilization had been shown to be vital for the invasion of plants by symbiotic rhizobia, and a similar defect had been expected in *D. dadantii*.

Although *D. dadantii* has an operon containing arylsulfatase genes, it was unable to grow on arylsulfonates. Even more interesting, when this operon was deleted, a slowing, and in some cases complete attenuation, of infection was seen when infecting potato. Analysis of the protein structure of a hypothetical protein in this operon identified it as a phenol-dependent sulfotransferase. When tested, the enzymatic activity was indeed found to be dependent on phenol for activity (Figure 63). Additionally, the phenol dependent sulfotransferase activity was only seen under sulfur-limiting conditions. This was consistent with the expression pattern seen in the *ats* promoter induction experiments (Figure 60).

Sulfotransferase activity has been shown to be used by plants to regulate internal salicylic acid levels through the sulfonation of salicylic acid. Disruption of this regulation of salicylic acid has been shown to increase the plant's susceptibility to bacterial pathogens (Baek et al. 2010). Additionally, sulfotransferase activity has been identified in *Mycobacterium tuberculosis* and has been linked to its virulence. It is responsible for creating the trehalose 2-sulfate moiety portion of the putative virulence factor sulfolipid-1 (Shi et al. 2007).

In this study, a phenol dependent sulfotransferase appears to be acting as a novel effector molecule to subvert host immunity. The hypothesized target of this putative

effector molecule would be the phenolic compound salicylic acid. As discussed earlier, salicylic acid plays a signaling role in host immunity. It is thought salicylic acid is being sulfonated by this novel enzyme, and this sulfonation is subverting the salicylic acid-induced immunity. This hypothesis was tested by inoculating cultures of *D. dadantii* with X-SO<sub>4</sub> and salicylic acid. As seen in Figure 65, sulfotransferase activity was observed with both phenol and salicylic acid, indicating that salicylic acid could be a target for this phenol dependent sulfotransferase.

This discovery of a potential salicylic acid targeting enzyme is an interesting next step in the arms race between plants and pathogens. While more work needs to be done to fully characterize this phenol-dependent sulfotransferase, this novel enzyme has the potential to aid in a better understanding of how *D. dadantii* evades the host immune system during soft rot infection.

## References

- Adams, T.H., McClung, C.R. & Chelm, B.K. 1984, "Physical organization of the Bradyrhizobium japonicum nitrogenase gene region", *Journal of Bacteriology*, vol. 159, no. 3, pp. 857-862.
- Agrios, G. 1997, "Significance of plant diseases", *Plant Pathology*, , pp. 25-37.
- Aguilar-Barajas, E., Díaz-Pérez, C., Ramírez-Díaz, M.I., Riveros-Rosas, H. & Cervantes, C. 2011, "Bacterial transport of sulfate, molybdate, and related oxyanions", *Biometals*, vol. 24, no. 4, pp. 687-707.
- Alfano, J.R. & Collmer, A. 2004, "Type III secretion system effector proteins: double agents in bacterial disease and plant defense", *Annu.Rev.Phytopathol.*, vol. 42, pp. 385-414.
- Andrio, E., Marino, D., Marmeys, A., Segonzac, M.D., Damiani, I., Genre, A., Huguet, S., Frendo, P., Puppo, A. & Pauly, N. 2013, "Hydrogen peroxide-regulated genes in the Medicago truncatula–Sinorhizobium meliloti symbiosis", *New Phytologist*, vol. 198, no. 1, pp. 179-189.
- Anthamatten, D., Scherb, B. & Hennecke, H. 1992, "Characterization of a fixLJ-regulated Bradyrhizobium japonicum gene sharing similarity with the Escherichia coli fnr and Rhizobium meliloti fixK genes", *Journal of Bacteriology*, vol. 174, no. 7, pp. 2111-2120.
- Antunez-Lamas, M., Cabrera-Ordóñez, E., Lopez-Solanilla, E., Raposo, R., Trelles-Salazar, O., Rodríguez-Moreno, A. & Rodríguez-Palenzuela, P. 2009, "Role of motility and chemotaxis in the pathogenesis of Dickeya dadantii 3937 (ex Erwinia chrysanthemi 3937)", *Microbiology (Reading, England)*, vol. 155, no. Pt 2, pp. 434-442.
- Åslund, F. & Beckwith, J. 1999, "Bridge over troubled waters: sensing stress by disulfide bond formation", *Cell*, vol. 96, no. 6, pp. 751-753.
- Baek, D., Pathange, P., CHUNG, J., Jiang, J., Gao, L., Oikawa, A., Hirai, M.Y., Saito, K., Pare, P.W. & Shi, H. 2010, "A stress-inducible sulphotransferase sulphonates salicylic acid and confers pathogen resistance in Arabidopsis", *Plant, Cell & Environment*, vol. 33, no. 8, pp. 1383-1392.
- Baginsky, C., Brito, B., Imperial, J., Palacios, J.M. & Ruiz-Argüeso, T. 2002, "Diversity and evolution of hydrogenase systems in rhizobia", *Applied and Environmental Microbiology*, vol. 68, no. 10, pp. 4915-4924.

- Baker, B., Zambryski, P., Staskawicz, B. & Dinesh-Kumar, S.P. 1997, "Signaling in plant-microbe interactions", *Science (New York, N.Y.)*, vol. 276, no. 5313, pp. 726-733.
- Barbour, W.M., Hattermann, D.R. & Stacey, G. 1991, "Chemotaxis of Bradyrhizobium japonicum to soybean exudates", *Applied and Environmental Microbiology*, vol. 57, no. 9, pp. 2635-2639.
- Bauer, D.W., Bogdanove, A.J., Beer, S.V. & Collmer, A. 1994, "Erwinia chrysanthemi hrp genes and their involvement in soft rot pathogenesis and elicitation of the hypersensitive response", *MPMI-Molecular Plant Microbe Interactions*, vol. 7, no. 5, pp. 573-581.
- Beaulieu, C., Boccarda, M. & Van Gijsegem, F. 1993, "Pathogenic behavior of pectinase-defective Erwinia chrysanthemi mutants on different plants", *Mol.Plant-Microbe Interact*, vol. 6, pp. 197-202.
- Berg, G. 2009, "Plant-microbe interactions promoting plant growth and health: perspectives for controlled use of microorganisms in agriculture", *Applied Microbiology and Biotechnology*, vol. 84, no. 1, pp. 11-18.
- Bocsanczy, A.M., Nissinen, R.M., OH, C. & Beer, S.V. 2008, "HrpN of Erwinia amylovora functions in the translocation of DspA/E into plant cells", *Molecular plant pathology*, vol. 9, no. 4, pp. 425-434.
- Bojović, B. & Marković, A. 2009, "Correlation between nitrogen and chlorophyll content in wheat (Triticum aestivum L.)", *Kragujevac Journal of Science*, vol. 31, pp. 69-74.
- Brown, K.A. 1982, "Sulphur in the environment: a review", *Environmental Pollution Series B, Chemical and Physical*, vol. 3, no. 1, pp. 47-80.
- Browse, J. 2009, "Jasmonate passes muster: a receptor and targets for the defense hormone", *Annual review of plant biology*, vol. 60, pp. 183-205.
- Charkowski, A., Blanco, C., Condemine, G., Expert, D., Franza, T., Hayes, C., Hugouvieux-Cotte-Pattat, N., Solanilla, E.L., Low, D. & Moleleki, L. 2012, "The role of secretion systems and small molecules in soft-rot enterobacteriaceae pathogenicity", *Annual Review of Phytopathology*, vol. 50, pp. 425-449.
- Cheng, H.P. & Walker, G.C. 1998, "Succinoglycan is required for initiation and elongation of infection threads during nodulation of alfalfa by Rhizobium meliloti", *Journal of Bacteriology*, vol. 180, no. 19, pp. 5183-5191.
- Collmer, A., Lindeberg, M., Petnicki-Ocwieja, T., Schneider, D.J. & Alfano, J.R. 2002, "Genomic mining type III secretion system effectors in Pseudomonas syringae yields

- new picks for all TTSS prospectors", *Trends in microbiology*, vol. 10, no. 10, pp. 462-469.
- Cook, R.J. 1998, "The molecular mechanisms responsible for resistance in plant-pathogen interactions of the gene-for-gene type function more broadly than previously imagined", *Proceedings of the National Academy of Sciences of the United States of America*, vol. 95, no. 17, pp. 9711-9712.
- Cowie, A., Cheng, J., Sibley, C.D., Fong, Y., Zaheer, R., Patten, C.L., Morton, R.M., Golding, G.B. & Finan, T.M. 2006, "An integrated approach to functional genomics: construction of a novel reporter gene fusion library for *Sinorhizobium meliloti*", *Applied and Environmental Microbiology*, vol. 72, no. 11, pp. 7156-7167.
- Dalton, D.A., Russell, S.A., Hanus, F.J., Pascoe, G.A. & Evans, H.J. 1986, "Enzymatic reactions of ascorbate and glutathione that prevent peroxide damage in soybean root nodules", *Proceedings of the National Academy of Sciences of the United States of America*, vol. 83, no. 11, pp. 3811-3815.
- Datsenko, K.A. & Wanner, B.L. 2000, "One-step inactivation of chromosomal genes in *Escherichia coli* K-12 using PCR products", *Proceedings of the National Academy of Sciences of the United States of America*, vol. 97, no. 12, pp. 6640-6645.
- Dean, D.R., Bolin, J.T. & Zheng, L. 1993, "Nitrogenase metalloclusters: structures, organization, and synthesis", *Journal of Bacteriology*, vol. 175, no. 21, pp. 6737-6744.
- Denison, R.F. 2000, "Legume sanctions and the evolution of symbiotic cooperation by rhizobia", *The American Naturalist*, vol. 156, no. 6, pp. 567-576.
- Dixon, R., Eady, R.R., Espin, G., Hill, S., Iaccarino, M., Kahn, D. & Merrick, M. 1980, "Analysis of regulation of *Klebsiella pneumoniae* nitrogen fixation (*nif*) gene cluster with gene fusions", .
- Dubery, I.A., Sanabria, N.M. & Huang, J. 2012, "Nonspecific perception in plant innate immunity" in *Self and Nonspecific* Springer, , pp. 79-107.
- Ehrhardt, D.W., Wais, R. & Long, S.R. 1996, "Calcium spiking in plant root hairs responding to *Rhizobium* nodulation signals", *Cell*, vol. 85, no. 5, pp. 673-681.
- Eisenbach, M. 1996, "Control of bacterial chemotaxis", *Molecular microbiology*, vol. 20, no. 5, pp. 903-910.
- Ellis, S.D., Boehm, M.J. & Coplin, D. 2008, "Bacterial diseases of plants", *Agriculture and Natural Resources*, .
- Fisher, R.F. & Long, S.R. 1992, "Rhizobium-plant signal exchange", .

- Flor, H.H. 1971, "Current status of the gene-for-gene concept", *Annual Review of Phytopathology*, vol. 9, no. 1, pp. 275-296.
- Fujishige, N.A., Kapadia, N.N., De Hoff, P.L. & Hirsch, A.M. 2006, "Investigations of Rhizobium biofilm formation", *FEMS microbiology ecology*, vol. 56, no. 2, pp. 195-206.
- Glazebrook, J. 2005, "Contrasting mechanisms of defense against biotrophic and necrotrophic pathogens", *Annu.Rev.Phytopathol.*, vol. 43, pp. 205-227.
- Gleason, C., Chaudhuri, S., Yang, T., Muñoz, A., Poovaiah, B. & Oldroyd, G.E. 2006, "Nodulation independent of rhizobia induced by a calcium-activated kinase lacking autoinhibition", *Nature*, vol. 441, no. 7097, pp. 1149-1152.
- Göhre, V. & Robatzek, S. 2008, "Breaking the barriers: microbial effector molecules subvert plant immunity", *Annu.Rev.Phytopathol.*, vol. 46, pp. 189-215.
- Goodsell, D. (2002, February 1). Nitrogenase. Retrieved January 15, 2015.
- Graham, P. 2008, "Ecology of the root-nodule bacteria of legumes" in *Nitrogen-fixing leguminous symbioses* Springer, , pp. 23-58.
- Gyaneshwar, P., Hirsch, A.M., Moulin, L., Chen, W., Elliott, G.N., Bontemps, C., Estrada-de los Santos, P., Gross, E., dos Reis Jr, Fabio Bueno & Sprent, J.I. 2011, "Legume-nodulating betaproteobacteria: diversity, host range, and future prospects", *Molecular Plant-Microbe Interactions*, vol. 24, no. 11, pp. 1276-1288.
- Harrison, J., Jamet, A., Muglia, C.I., Van de Sype, G., Aguilar, O.M., Puppo, A. & Frendo, P. 2005, "Glutathione plays a fundamental role in growth and symbiotic capacity of Sinorhizobium meliloti", *Journal of Bacteriology*, vol. 187, no. 1, pp. 168-174.
- Harshey, R.M. 2003, "Bacterial motility on a surface: many ways to a common goal", *Annual Reviews in Microbiology*, vol. 57, no. 1, pp. 249-273.
- Herridge, D.F., Peoples, M.B. & Boddey, R.M. 2008, "Global inputs of biological nitrogen fixation in agricultural systems", *Plant and Soil*, vol. 311, no. 1-2, pp. 1-18.
- Hirsch, A.M. 1999, "Role of lectins (and rhizobial exopolysaccharides) in legume nodulation", *Current opinion in plant biology*, vol. 2, no. 4, pp. 320-326.
- HIRSCH, A.M. 1992, "Developmental biology of legume nodulation", *New Phytologist*, vol. 122, no. 2, pp. 211-237.

- Ho, L.T., Nomura, M. & Tajima, S. 2004, "Characterization of bacteroid proteins in soybean nodules formed with *Bradyrhizobium japonicum* USDA110", *Microbes and Environments*, vol. 19, no. 1, pp. 71-75.
- Huang, Z., Jiang, D., Yang, Y., Sun, J. & Jin, S. 2004, "Effects of nitrogen deficiency on gas exchange, chlorophyll fluorescence, and antioxidant enzymes in leaves of rice plants", *Photosynthetica*, vol. 42, no. 3, pp. 357-364.
- Hugouvieux-Cotte-Pattat, N., Condemine, G., Nasser, W. & Reverchon, S. 1996, "Regulation of pectinolysis in *Erwinia chrysanthemi*", *Annual Reviews in Microbiology*, vol. 50, no. 1, pp. 213-257.
- Hutchins, William Cortrell, "Cellular Metabolism and Its Effect on the Type III Secretion System of *Dickeya Dadantii* 3937" (2013). *Theses and Dissertations*. Paper 330.
- Irwin, J.G., Campbell, G. & Vincent, K. 2002, "Trends in sulphate and nitrate wet deposition over the United Kingdom: 1986–1999", *Atmospheric Environment*, vol. 36, no. 17, pp. 2867-2879.
- Jensen, E.S., Andersen, A. & Thomsen, J. 1985, "The influence of seed-borne N in <sup>15</sup>N isotope dilution studies with legumes", *Acta Agriculturae Scandinavica*, vol. 35, no. 4, pp. 438-443.
- Jha, G., Rajeshwari, R. & Sonti, R.V. 2007, "Functional interplay between two *Xanthomonas oryzae* pv. *oryzae* secretion systems in modulating virulence on rice", *Molecular Plant-Microbe Interactions*, vol. 20, no. 1, pp. 31-40.
- Jones, J.D. & Dangl, J.L. 2006, "The plant immune system", *Nature*, vol. 444, no. 7117, pp. 323-329.
- Jones, K.M., Kobayashi, H., Davies, B.W., Taga, M.E. & Walker, G.C. 2007, "How rhizobial symbionts invade plants: the *Sinorhizobium*–*Medicago* model", *Nature Reviews Microbiology*, vol. 5, no. 8, pp. 619-633.
- Kahnert, A., Mirleau, P., Wait, R. & Kertesz, M.A. 2002, "The LysR-type regulator SftR is involved in soil survival and sulphate ester metabolism in *Pseudomonas putida*", *Environmental microbiology*, vol. 4, no. 4, pp. 225-237.
- Kahnert, A. & Kertesz, M.A. 2000, "Characterization of a sulfur-regulated oxygenative alkylsulfatase from *Pseudomonas putida* S-313", *The Journal of biological chemistry*, vol. 275, no. 41, pp. 31661-31667.
- Kapoor, A. & Viraraghavan, T. 1997, "Nitrate removal from drinking water-review", *Journal of Environmental Engineering*, vol. 123, no. 4, pp. 371-380.

- Kertesz, M.A., Fellows, E. & Schmalenberger, A. 2007, "Rhizobacteria and plant sulfur supply", *Advances in Applied Microbiology*, vol. 62, pp. 235-268.
- Kertesz, M.A. & Mirleau, P. 2004, "The role of soil microbes in plant sulphur nutrition", *Journal of experimental botany*, vol. 55, no. 404, pp. 1939-1945.
- Khan, N.A., Singh, S. & Umar, S. 2008, *Sulfur assimilation and abiotic stress in plants*, Springer.
- Lamb, C.J. 1994, "Plant disease resistance genes in signal perception and transduction", *Cell*, vol. 76, no. 3, pp. 419-422.
- Leigh, J.A., Signer, E.R. & Walker, G.C. 1985, "Exopolysaccharide-deficient mutants of *Rhizobium meliloti* that form ineffective nodules", *Proceedings of the National Academy of Sciences of the United States of America*, vol. 82, no. 18, pp. 6231-6235.
- Leustek, T., Martin, M.N., Bick, J. & Davies, J.P. 2000, "Pathways and regulation of sulfur metabolism revealed through molecular and genetic studies", *Annual review of plant biology*, vol. 51, no. 1, pp. 141-165.
- Li, Y., Tian, C.F., Chen, W.F., Wang, L., Sui, X.H. & Chen, W.X. 2013, "High-resolution transcriptomic analyses of *Sinorhizobium* sp. NGR234 bacteroids in determinate nodules of *Vigna unguiculata* and indeterminate nodules of *Leucaena leucocephala*", *PloS one*, vol. 8, no. 8, pp. e70531.
- López, M.A., Bannenberg, G. & Castresana, C. 2008, "Controlling hormone signaling is a plant and pathogen challenge for growth and survival", *Current opinion in plant biology*, vol. 11, no. 4, pp. 420-427.
- López-Solanilla, E., Llama-Palacios, A., Collmer, A., García-Olmedo, F. & Rodríguez-Palenzuela, P. 2001, "Relative effects on virulence of mutations in the sap, pel, and hrp loci of *Erwinia chrysanthemi*", *Molecular Plant-Microbe Interactions*, vol. 14, no. 3, pp. 386-393.
- Lux, R. & Shi, W. 2004, "Chemotaxis-guided movements in bacteria", *Critical reviews in oral biology and medicine : an official publication of the American Association of Oral Biologists*, vol. 15, no. 4, pp. 207-220.
- MacNeil, T., MacNeil, D., Roberts, G.P., Supiano, M.A. & Brill, W.J. 1978, "Fine-structure mapping and complementation analysis of nif (nitrogen fixation) genes in *Klebsiella pneumoniae*", *Journal of Bacteriology*, vol. 136, no. 1, pp. 253-266.
- Marcel, S., Sawers, R., Oakeley, E., Angliker, H. & Paszkowski, U. 2010, "Tissue-adapted invasion strategies of the rice blast fungus *Magnaporthe oryzae*", *The Plant Cell*, vol. 22, no. 9, pp. 3177-3187.

- Matsumoto, H., Muroi, H., Umehara, M., Yoshitake, Y. & Tsuyumu, S. 2003, "Peh production, flagellum synthesis, and virulence reduced in *Erwinia carotovora* subsp. *carotovora* by mutation in a homologue of *cytR*", *Molecular Plant-Microbe Interactions*, vol. 16, no. 5, pp. 389-397.
- Mergaert, P., Uchiumi, T., Alunni, B., Evanno, G., Cheron, A., Catrice, O., Mausset, A.E., Barloy-Hubler, F., Galibert, F., Kondorosi, A. & Kondorosi, E. 2006, "Eukaryotic control on bacterial cell cycle and differentiation in the *Rhizobium*-legume symbiosis", *Proceedings of the National Academy of Sciences of the United States of America*, vol. 103, no. 13, pp. 5230-5235.
- Mevarech, M., Rice, D. & Haselkorn, R. 1980, "Nucleotide sequence of a cyanobacterial *nifH* gene coding for nitrogenase reductase", *Proceedings of the National Academy of Sciences of the United States of America*, vol. 77, no. 11, pp. 6476-6480.
- Miller, J.H. "Experiments in molecular genetics", Cold Spring Harbor Laboratory, 1972, print.
- Mishina, T.E. & Zeier, J. 2007, "Pathogen-associated molecular pattern recognition rather than development of tissue necrosis contributes to bacterial induction of systemic acquired resistance in *Arabidopsis*", *The Plant Journal*, vol. 50, no. 3, pp. 500-513.
- Moore, J.W., Loake, G.J. & Spoel, S.H. 2011, "Transcription dynamics in plant immunity", *The Plant Cell*, vol. 23, no. 8, pp. 2809-2820.
- Murray, J.D., Karas, B.J., Sato, S., Tabata, S., Amyot, L. & Szczyglowski, K. 2007, "A cytokinin perception mutant colonized by *Rhizobium* in the absence of nodule organogenesis", *Science (New York, N.Y.)*, vol. 315, no. 5808, pp. 101-104.
- Oldroyd, G.E. & Downie, J.A. 2008, "Coordinating nodule morphogenesis with rhizobial infection in legumes", *Annu.Rev.Plant Biol.*, vol. 59, pp. 519-546.
- Palermo, R., Singh, R., Bashkin, J. & Holm, R. 1984, "Molybdenum atom ligand substitution reactions of molybdenum-iron-sulfur ( $\text{MoFe}_3\text{S}_4$ ) cubane-type clusters: synthesis and structures of clusters containing molybdenum-bound pseudosubstrates of nitrogenase", *Journal of the American Chemical Society*, vol. 106, no. 9, pp. 2600-2612.
- Passardi, F., Cosio, C., Penel, C. & Dunand, C. 2005, "Peroxidases have more functions than a Swiss army knife", *Plant Cell Reports*, vol. 24, no. 5, pp. 255-265.
- Peng, Q., Yang, S., Charkowski, A.O., Yap, M., Steeber, D.A., Keen, N.T. & Yang, C. 2006, "Population behavior analysis of *dspE* and *pelD* regulation in *Erwinia chrysanthemi* 3937", *Molecular Plant-Microbe Interactions*, vol. 19, no. 4, pp. 451-457.

- Penmetsa, R.V., Frugoli, J.A., Smith, L.S., Long, S.R. & Cook, D.R. 2003, "Dual genetic pathways controlling nodule number in *Medicago truncatula*", *Plant Physiology*, vol. 131, no. 3, pp. 998-1008.
- Perombelon, M.C. & Kelman, A. 1980, "Ecology of the soft rot erwinias", *Annual Review of Phytopathology*, vol. 18, no. 1, pp. 361-387.
- Peters, J.W., Fisher, K. & Dean, D.R. 1995, "Nitrogenase structure and function: a biochemical-genetic perspective", *Annual Reviews in Microbiology*, vol. 49, no. 1, pp. 335-366.
- Peters, J.W., Stowell, M.H., Soltis, S.M., Finnegan, M.G., Johnson, M.K. & Rees, D.C. 1997, "Redox-dependent structural changes in the nitrogenase P-cluster", *Biochemistry*, vol. 36, no. 6, pp. 1181-1187.
- Pieterse, C.M., Leon-Reyes, A., Van der Ent, S. & Van Wees, S.C. 2009, "Networking by small-molecule hormones in plant immunity", *Nature chemical biology*, vol. 5, no. 5, pp. 308-316.
- Pilon-Smits, E.A. & Pilon, M. 2006, "Sulfur metabolism in plastids" in *The Structure and Function of Plastids* Springer, , pp. 387-402.
- Quinto, C., De La Vega, H., Flores, M., Leemans, J., Cevallos, M.A., Pardo, M.A., Azpiroz, R., De Lourdes Girard, M., Calva, E. & Palacios, R. 1985, "Nitrogenase reductase: A functional multigene family in *Rhizobium phaseoli*", *Proceedings of the National Academy of Sciences of the United States of America*, vol. 82, no. 4, pp. 1170-1174.
- Rausch, T. & Wachter, A. 2005, "Sulfur metabolism: a versatile platform for launching defence operations", *Trends in plant science*, vol. 10, no. 10, pp. 503-509.
- Ribaudo, M.O., Heimlich, R., Claassen, R. & Peters, M. 2001, "Least-cost management of nonpoint source pollution: source reduction versus interception strategies for controlling nitrogen loss in the Mississippi Basin", *Ecological Economics*, vol. 37, no. 2, pp. 183-197.
- Riccillo, P.M., Muglia, C.I., de Bruijn, F.J., Roe, A.J., Booth, I.R. & Aguilar, O.M. 2000, "Glutathione is involved in environmental stress responses in *Rhizobium tropici*, including acid tolerance", *Journal of Bacteriology*, vol. 182, no. 6, pp. 1748-1753.
- Robert-Seilaniantz, A., Grant, M. & Jones, J.D. 2011, "Hormone crosstalk in plant disease and defense: more than just jasmonate-salicylate antagonism", *Annual Review of Phytopathology*, vol. 49, pp. 317-343.
- Roche, P., Debelle, F., Maillet, F., Lerouge, P., Faucher, C., Truchet, G., Dénarié, J. & Promé, J. 1991, "Molecular basis of symbiotic host specificity in *Rhizobium*

- meliloti: nodH and nodPQ genes encode the sulfation of lipo-oligosaccharide signals", *Cell*, vol. 67, no. 6, pp. 1131-1143.
- Rodionov, D.A., Vitreschak, A.G., Mironov, A.A. & Gelfand, M.S. 2004, "Comparative genomics of the methionine metabolism in Gram-positive bacteria: a variety of regulatory systems", *Nucleic acids research*, vol. 32, no. 11, pp. 3340-3353.
- Ruvkun, G.B. & Ausubel, F.M. 1980, "Interspecies homology of nitrogenase genes", *Proceedings of the National Academy of Sciences of the United States of America*, vol. 77, no. 1, pp. 191-195.
- Santos, R., Hérouart, D., Sigaud, S., Touati, D. & Puppo, A. 2001, "Oxidative burst in alfalfa-Sinorhizobium meliloti symbiotic interaction", *Molecular Plant-Microbe Interactions*, vol. 14, no. 1, pp. 86-89.
- Selhub, J. 1999, "Homocysteine metabolism", *Annual Review of Nutrition*, vol. 19, no. 1, pp. 217-246.
- Shi, R., Lamb, S.S., Bhat, S., Sulea, T., Wright, G.D., Matte, A. & Cygler, M. 2007, "Crystal structure of StaL, a glycopeptide antibiotic sulfotransferase from *Streptomyces toyocaensis*", *The Journal of biological chemistry*, vol. 282, no. 17, pp. 13073-13086.
- Spencer, J.B., Stolowich, N.J., Roessner, C.A. & Scott, A.I. 1993, "The *Escherichia coli* cysG gene encodes the multifunctional protein, siroheme synthase", *FEBS letters*, vol. 335, no. 1, pp. 57-60.
- Stebbins, C.E. & Galán, J.E. 2003, "Priming virulence factors for delivery into the host", *Nature Reviews Molecular Cell Biology*, vol. 4, no. 9, pp. 738-744.
- Subramanian, S., Stacey, G. & Yu, O. 2007, "Distinct, crucial roles of flavonoids during legume nodulation", *Trends in plant science*, vol. 12, no. 7, pp. 282-285.
- Tirichine, L., James, E.K., Sandal, N. & Stougaard, J. 2006, "Spontaneous root-nodule formation in the model legume *Lotus japonicus*: a novel class of mutants nodulates in the absence of rhizobia", *Molecular Plant-Microbe Interactions*, vol. 19, no. 4, pp. 373-382.
- Tsiamis, G., Mansfield, J.W., Hockenhull, R., Jackson, R.W., Sesma, A., Athanassopoulos, E., Bennett, M.A., Stevens, C., Vivian, A. & Taylor, J.D. 2000, "Cultivar-specific avirulence and virulence functions assigned to avrPphF in *Pseudomonas syringae* pv. phaseolicola, the cause of bean halo-blight-disease", *The EMBO journal*, vol. 19, no. 13, pp. 3204-3214.
- Udvardi, M. & Poole, P.S. 2013, "Transport and metabolism in legume-rhizobia symbioses", *Annual review of plant biology*, vol. 64, pp. 781-805.

- Van de Velde, W., Guerra, J.C., De Keyser, A., De Rycke, R., Rombauts, S., Maunoury, N., Mergaert, P., Kondorosi, E., Holsters, M. & Goormachtig, S. 2006, "Aging in legume symbiosis. A molecular view on nodule senescence in *Medicago truncatula*", *Plant Physiology*, vol. 141, no. 2, pp. 711-720.
- Van den Ackerveken, G. & Bonas, U. 1997, "Bacterial avirulence proteins as triggers of plant disease resistance", *Trends in microbiology*, vol. 5, no. 10, pp. 394-398.
- Vanbleu, E., Marchal, K. & Vanderleyden, J. 2004, "Genetic and physical map of the pLAFR1 vector", *Mitochondrial DNA*, vol. 15, no. 3, pp. 225-227.
- Vashchenko, L.M. & Hvozdiak, R.I. 2007, "The type III proteins secretion system in phytopathogenic bacteria", *Mikrobiolohichniy zhurnal (Kiev, Ukraine : 1993)*, vol. 69, no. 3, pp. 74-85.
- Vesper, S.J. & Bauer, W.D. 1986, "Role of Pili (Fimbriae) in Attachment of *Bradyrhizobium japonicum* to Soybean Roots", *Applied and Environmental Microbiology*, vol. 52, no. 1, pp. 134-141.
- Vlot, A.C., Dempsey, D.A. & Klessig, D.F. 2009, "Salicylic acid, a multifaceted hormone to combat disease", *Annual Review of Phytopathology*, vol. 47, pp. 177-206.
- Whipps, J.M. 2001, "Microbial interactions and biocontrol in the rhizosphere", *Journal of experimental botany*, vol. 52, no. Spec Issue, pp. 487-511.
- Yang, W.C., de Blank, C., Meskiene, I., Hirt, H., Bakker, J., van Kammen, A., Franssen, H. & Bisseling, T. 1994, "Rhizobium nod factors reactivate the cell cycle during infection and nodule primordium formation, but the cycle is only completed in primordium formation", *The Plant Cell*, vol. 6, no. 10, pp. 1415-1426.
- Zeng, Q. 2011, *The study of genetic regulation of the type III secretion system in *Dickeya dadantii* 3937 regulation by PNPase, small RNA and at single cell level*, The University of Wisconsin - Milwaukee.

## Curriculum vitae

### Justin J. Speck

#### Education:

2009-2015	Ph.D. Biological Sciences University of Wisconsin- Milwaukee	Department of Biological Sciences Milwaukee, WI 53211
2000-2004	BS Biological Sciences	Department of Biological Sciences St Paul, MN 55112

#### Publications: Peer Reviewed Journals:

Sugawara, M., Shah, G.R., Sadowsky, M.J., Paliy, O., **Speck, J.**, Vail, A.W. & Gyaneshwar, P. 2011, "Expression and Functional Roles of Bradyrhizobium japonicum Genes Involved in the Utilization of Inorganic and Organic Sulfur Compounds in Free-Living and Symbiotic Conditions", *Molecular Plant-Microbe Interactions*, vol. 24, no. 4, pp. 451-457.

#### Presentations:

**Speck, J.**, Gyaneshwar P. Poster presentation: Expression of sulfur utilization genes in *Sinorhizobium meliloti* during infection and symbiosis with Alfalfa. 2014 Biological Sciences Research Symposium. Milwaukee, WI. April 23, 2014.

**Speck, J.**, Gyaneshwar P. Poster presentation: The Role of Sulfur Metabolites on the Regulation of *fix* Genes and *fix* Induced Sulfur Metabolism in *Bradyrhizobium japonicum* USDA 110. 2013 Biological Sciences Research Symposium. Milwaukee, WI. April 18, 2013.

**Speck, J.**, Dornfeld CL, Shah G.R., and Gyaneshwar P. Organic Sulfur Metabolism and Nitrogen Fixation in *Bradyrhizobium japonicum* USDA110. 2011 Biological Sciences Research Symposium. Milwaukee, WI. April 22, 2011.

**Speck, J.**, Shah G.R., Suagawara M., Sadowsky M., and Gyaneshwar P. Poster Presentation: Functional and ecological genomics of organosulfur utilization by soybean nodulating *Bradyrhizobium japonicum* USDA110. 2010 Biological Sciences Research Symposium. Milwaukee, WI. April 22, 2010.

#### Scholarships /Awards:

- Chancellors Fellowship awarded by University of Wisconsin-Milwaukee (2009-13)

Work Experience:

2009-2015	Teaching Assistant Microbiology 101 and 383	Department of Biological Sciences Milwaukee, WI 53211
2005-2009	High School Educator Chemistry, AP Chemistry Physics, & Physical Science	Yongson International School of Seoul San 10-213 Hannam dong, Yongsan ku Seoul, Korea 140-210
2003-2004	Certified Nursing Assistant	Fairhaven Christian Retirement 3470 N. Alpine Road Rockford, Illinois 61114

Volunteer Experience

2010-present	Usher	Elm Grove Ev Lutheran Church
2013-2014	T-Ball Coach	Elm Grove T-ball league
2013-present	Elder Board	Elm Grove Ev Lutheran Church