

THE DYNAMICS AND SPECIATION OF ARSENIC IN DRINKING WATER WELLS IN  
EASTERN WISCONSIN

by

Evvan Plank

A Thesis Submitted in  
Partial Fulfillment of the  
Requirements for the Degree of

Master of Science  
in Geosciences

at

The University of Wisconsin-Milwaukee

December 2019

## ABSTRACT

### THE DYNAMICS AND SPECIATION OF ARSENIC IN DRINKING WATER WELLS IN EASTERN WISCONSIN

by

Evvan Plank

The University of Wisconsin-Milwaukee, 2019  
Under the Supervision of Professor Shangping Xu

Arsenic typically develops in Eastern Wisconsin groundwater as a result of oxidation of sulfide bearing minerals in the limestone bedrock (Schreiber et al. 2000). Naturally occurring arsenic exists in groundwater as oxyanions which have two oxidation states, As(III) and As(V). Under ambient pH conditions As(V) is primarily present as an anion (i.e.,  $\text{H}_2\text{AsO}_4^-$ ) while As(III) tends to be uncharged (i.e.,  $\text{H}_3\text{AsO}_3$ ), making it much more difficult to remove through the existing treatment techniques such as adsorption and reverse osmosis (RO). Although many studies exist establishing arsenic concentrations across Wisconsin, there is a lack of investigations into the concentrations of each arsenic species as well as minute-scale arsenic dynamics, which is essential for establishing a removal technique. The primary goals of this research were to establish baseline concentrations of each arsenic species, accounting for seasonal variations, and determine how these concentrations could be affected by strenuous water usage. Private drinking water wells were selected at 16 locations across Eastern Wisconsin. The wells were screened at various depths, in multiple geologic units, and contained a wide-range of total arsenic concentrations. Analysis of the speciation data indicated that As(III)

was the dominant species of arsenic in all of the wells sampled. Data from the 11 pumping tests that were conducted, showed 9 exhibiting a downward trend in As(III) concentration and an upward trend in As(V) concentration as volume purged increased. The pumping tests also showed a substantial increase in total arsenic in many of the wells as volume purged increased. The results of this study suggest that there is an elevated health risk of consuming water following short-term strenuous water usage and an increased necessity for proper filtration due to dominant As(III) concentrations.

© Copyright by Evvan Plank, 2019  
All Rights Reserved

TABLE OF CONTENTS

List of Figures ..... viii

List of Tables ..... xi

List of Abbreviations ..... xii

Acknowledgements..... xiii

Chapter 1: Introduction..... 1

    1.1 Objectives and Significance..... 3

    1.2 Health Implications ..... 3

    1.3 Arsenic Species ..... 4

    1.4 Pleistocene Sand and Gravel Aquifer ..... 6

        1.4.1 Release Mechanism ..... 7

    1.5 Eastern Silurian Dolomite Aquifer ..... 7

        1.5.1 Release Mechanism ..... 8

    1.6 Cambrian-Ordovician Sandstone and Dolomite Aquifer..... 9

        1.6.1 Release Mechanism ..... 10

    1.7 Study Area ..... 13

    1.8 Well Construction Reports..... 14

Chapter 2: Method ..... 19

2.1 Sampling .....	19
2.2 Pumping .....	23
2.3 Preservation.....	24
2.4 Ion Determination .....	25
2.4.1 Field Measurements .....	25
2.4.2 Lab Measurements .....	26
2.5 Arsenic Determination .....	27
<b>Chapter 3: Results and Discussion .....</b>	<b>29</b>
3.1 All Locations.....	29
3.1.1 Total Arsenic.....	29
3.1.2 Speciation.....	30
3.1.3 Geologic Units .....	31
3.2 Group 1: Substantial Arsenic Increase.....	32
3.3 Group 2: Moderate Arsenic Increase .....	40
3.4 Group 3: Unsubstantial Arsenic Increase .....	45
3.5 Comprehensive Geologic Interpretation of Arsenic Dynamics.....	50
<b>Chapter 4: Conclusions.....</b>	<b>51</b>
<b>References.....</b>	<b>53</b>

Appendices .....	58
Appendix A: Data Tables.....	59
Appendix B: Additional Analytical Figures .....	82

## LIST OF FIGURES

Figure 1. Reprinted from “Arsenic and other Naturally-Occurring Elements”, 2019 Wisconsin Groundwater Coordinating Council Report to the Legislature, p. 3.....	2
Figure 2. Arsenic Eh-pH Diagram. Reprinted from Lu, P. & Zhu, C. Environ Earth Sci (2011) ..	5
Figure 3. Sand and gravel aquifer (brown). Reprinted from Wisconsin Geological and Natural History Survey "Wisconsin Aquifers".....	6
Figure 4. Eastern dolomite aquifer (purple). Reprinted from Wisconsin Geological and Natural History Survey "Wisconsin Aquifers".....	7
Figure 5. Sulfide mineral, pyrite, found in dolomite rock. ....	9
Figure 6. Sandstone and dolomite aquifer (blue). Reprinted from Wisconsin Geological and Natural History Survey "Wisconsin Aquifers".....	10
Figure 7. Geologic section showing major units (Schreiber et al. 1999).....	11
Figure 8. Oxidation of sulfide cement horizon via borehole interaction. Static conditions (top), oxidizing conditions (bottom).....	12
Figure 9. Map of study area. Wisconsin filled in red (top). Wisconsin bedrock map outlining counties in study area in red (left). County map displaying well locations (right).....	13
Figure 10. Location L1 well construction report. ....	15
Figure 11. Location L2 well construction report. ....	15
Figure 12. Location L3 well construction report. ....	16
Figure 13. Location L4 well construction report. ....	16
Figure 14. Location L5 well construction report. ....	17
Figure 15. Location L6 well construction report. ....	17
Figure 16. Location L9 well construction report. ....	17

Figure 17. Location L13 well construction report. ....	17
Figure 18. Location L14 well construction report. ....	18
Figure 19. Location L15 well construction report. ....	18
Figure 20. Location L16 well construction report. ....	18
Figure 21. Location L18 well construction report. ....	18
Figure 22. Well Diagram. Reprinted from Minnesota Department of Health “Well Owner’s Handbook”. ....	20
Figure 23. Measuring field parameters using YSI Professional Plus multiparameter instrument at location L3. ....	21
Figure 24. 1-hour pump test at location L9.....	22
Figure 25. 1-hour pump test at location L2.....	22
Figure 26. As(III) & As(V) separation process (Trujillo, D., & Wang, Y. 2018) .....	27
Figure 27. Removal efficiency of ion exchange resin (50:50 species solutions).....	28
Figure 28. Removal efficiency of ion exchange resin (Individual species solutions). ....	28
Figure 29. Elevation & geologic unit of well screens vs total arsenic concentration. ....	31
Figure 30. Three pump tests conducted at location L5. Comparing volume pumped (gallons) to total arsenic concentration (ug/L). ....	31
Figure 31. Four pump tests conducted at location L6. Comparing volume pumped (gallons) to total arsenic concentration (ug/L). ....	31
Figure 32. Pump test conducted at location L15. Comparing volume pumped (gallons) to total arsenic concentration (ug/L). ....	31
Figure 33. Arsenic concentrations following 1-hour pump tests. Location L5 (top) and Location L6 (bottom) show rebounding arsenic values. ....	31

Figure 34. Location L5 arsenic species (C/Co) variation through pumping..... 31

Figure 35. Location L6 arsenic species (C/Co) variation through pumping (tests 1-2). ..... 31

Figure 36. Location L6 arsenic species (C/Co) variation through pumping (tests 3-4). ..... 31

Figure 37. Location L15 arsenic species (C/Co) variation through pumping..... 31

Figure 38. Pump test conducted at location L3. Comparing volume pumped (gallons) to total arsenic (left axis) and sulfate (right axis) concentration. .... 31

Figure 39. Pump test conducted at location L9. Comparing volume pumped (gallons) to total arsenic concentration (ug/L). .... 31

Figure 40. Pump test conducted at location L18. Comparing volume pumped (gallons) to total arsenic concentration (ug/L). .... 31

Figure 41. Locations L3 (top), L9 (middle), & L18 (bottom) arsenic species (C/Co) variation through pumping ..... 31

Figure 42. Pump test conducted at location L1. Comparing volume pumped (gallons) to total arsenic (left axis) and sulfate (right axis) concentration. .... 31

Figure 43. Pump tests conducted at location L2 (top) & L16 (bottom). Comparing volume pumped (gallons) to total arsenic concentration (ug/L). .... 31

Figure 44. Locations L1 (top), L2 (middle), & L16 (bottom) arsenic species (C/Co) variation through pumping. .... 31

LIST OF TABLES

Table 1. Well locations, aquifers, and screened intervals. .... 14

Table 2. Trip blank tests using 50:50 mixtures of As(III) and As(V) species. Red outline denotes % change during trip. .... 25

Table 3. Water quality measures and total arsenic concentrations at 16 well locations during winter sampling events. .... 29

Table 4. Seasonal arsenic speciation at 11 well locations. .... 30

## LIST OF ABBREVIATIONS

$\Delta$	Change
As	Arsenic
As(III)	Arsenite or arsenic +3 oxidation state
As(V)	Arsenate or arsenic +5 oxidation state
$C/C_o$	Concentration $\div$ Initial Concentration
EPA	Environmental Protection Agency
MCL	Maximum contamination limit
mg/kg	Milligrams per kilogram (ppm)
n.a.	Not applicable
n.d.	Not detectable
ORP	Oxidation Reduction Potential
ug/L	Micrograms per Liter (Parts per billion)
QA	Quality Assurance
QC	Quality Control
SCH	Sulfide Cement Horizon
TDS	Total Dissolved Solids
USGS	United States Geological Survey
WDNR	Wisconsin Department of Natural Resources

## ACKNOWLEDGEMENTS

I would like to thank my Advisor, Dr. Shangping Xu, for not only providing me with a very interesting research project, but also challenging me throughout my master's degree to create the best product. I also thank him for offering me an undergraduate research opportunity which motivated me to pursue my master's degree at UWM. I thank Dr. Yin Wang for his advice throughout my research and providing the arsenic separation technique utilized in this research. I thank Dr. Charles Paradis for his assistance while analyzing my results. I thank Patrick Anderson at the School of Freshwater Sciences for his assistance with water analysis and data interpretation along with helping me operate the equipment, I certainly could not have completed this research without him. I thank my family and friends for their love and support throughout my collegiate career. Lastly, I would like to thank my partner, Shawna Rickard, for being there for me every step of the way.

## Chapter 1: Introduction

Naturally occurring arsenic is a common constituent in many groundwater systems throughout the world and is considered one of the top environmental causes for cancer mortality and birth complications (Smith et al. 1992). In Bangladesh, arsenic contamination is considered the largest poisoning of a population in history, with an average concentration of 500 ug/L (ppb) and between 35 million and 77 million people are at risk (Smith et al. 2000). Due to the increasing concern of health implications, the Environmental Protection Agency (EPA) lowered the maximum contamination limit (MCL) for arsenic in public drinking water from 50 ug/L to 10 ug/L in 2001. Households that rely on private domestic wells, however, are responsible for testing their own drinking water, and are often unaware of the risk. In 2017, the United States Geological Survey (USGS) estimated that 44 million people in the United States use private domestic wells for their drinking water and 2.1 million of those people are affected by arsenic concentrations above the EPA MCL (USGS, 2017).

Recognizing the international crisis, the Wisconsin Department of Natural Resources (WDNR) began requiring arsenic sampling on private wells (>20,000 locations) during phases of repair, to get a better understanding of the spatial distribution of arsenic concentrations. The data from the research revealed that many counties in Eastern Wisconsin contained wells with arsenic above the EPA MCL (Figure 1), and several wells exhibited concentrations exceeding 1,000 ug/L. The locations from the WDNR study that contained elevated concentrations of arsenic were utilized as references for site selection in this research.

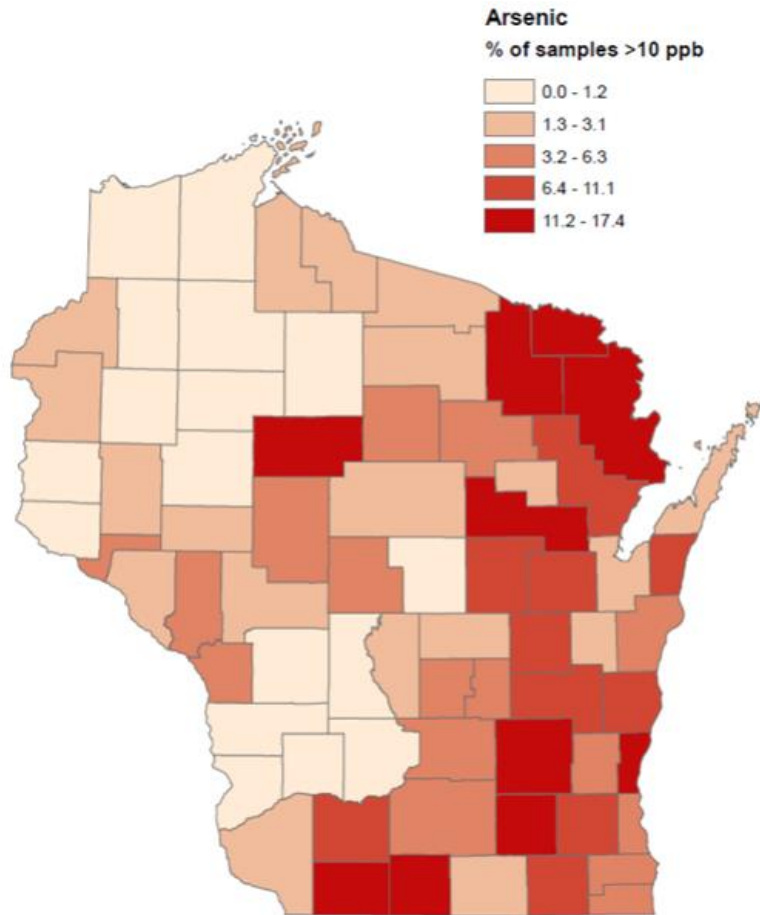

Figure 1. Reprinted from "Arsenic and other Naturally-Occurring Elements", 2019 Wisconsin Groundwater Coordinating Council Report to the Legislature, p. 3.

In the Fox River Valley region, located in East-Central Wisconsin, >18% of private water-supply wells exceed the 10 ug/L drinking water standard (Thornburg and Sahai, 2004). Extensive water sampling studies carried out in Outagamie and Winnebago Counties showed that 3% of drinking water wells had arsenic concentrations higher than 50 ug/L and 20% of well had arsenic concentrations higher than 10 ug/L (Riewe, 2000). In Southeastern Wisconsin where limited data is available, the Ozaukee County Public Health Department reported that 24 out of 167 wells tested in 2009 had As concentrations higher than 10 ug/L (Benson, 2009). These concentrations vary extensively from region to region depending on several geologic factors.

## **1.1 Objectives and Significance**

The objectives of this research were to determine spatial and temporal variations as well as the speciation and minute-scale pumping variation (dynamics) of arsenic concentrations in private drinking water wells in various aquifers throughout Eastern Wisconsin. It was hypothesized that arsenic concentrations will not behave similarly across all aquifers due to different aquifer materials, so it was essential to obtain a comprehensive list of participants. Using the WDNR data from 1993-2017, changes in arsenic concentrations throughout extensive periods of time could be used to help predict future arsenic levels. It is also important to understand when one is most susceptible to high levels of arsenic (i.e., in the morning when no water has been pumped, or afternoon when water use is at a maximum). Thus, concentrations were determined early in the morning prior to use, and 1-hour pump tests were conducted to determine how these concentrations change with water use. Additionally, it is important to understand that the speciation of As, as As(III) and As(V) differ substantially in terms of toxicity, mobility and removal techniques. Therefore, the speciation of As was determined through this research.

## **1.2 Health Implications**

Arsenic is responsible for various short and long-term health effects in humans. Toxicological studies have revealed the acute and chronic effects of inorganic arsenic exposure, including but not limited to: cardiovascular disease, blood disorders, gastrointestinal complications, neurologic disorders, pulmonary disease, renal failure, skin lesions, and cancer (States, 2015). The lethal range of inorganic arsenic in the adult human body is estimated between 1-3 mg As/kg (Ellenhorn et al., 1997), however, lower concentrations can also cause

serious health issues. In cases such as Bangladesh, where the average concentration of arsenic that one is consuming is 500  $\mu\text{g/L}$ , by the age of 60 years, more than 1 out of 10 people will have developed skin cancer (Smith et al. 2000). It was estimated that at the previous EPA maximum contamination limit (MCL) of 50  $\mu\text{g/L}$ , the lifetime risk of dying from liver, lung, kidney, and bladder cancer was as high as 13 out of 1,000 persons (Smith et al., 1992). Findings such as these led the EPA to lower their MCL to 10  $\mu\text{g/L}$ .

### 1.3 Arsenic Species

Many previous studies have established total arsenic concentrations in Wisconsin's aquifers. However, most of these studies did not examine the dynamics as well as the speciation of As within private well water. Arsenic exists in groundwater as oxyanions which have two oxidation states, As(III) (arsenite) and As(V) (arsenate). Under circumneutral groundwater conditions As(V) is primarily present as an anion (i.e.,  $\text{H}_2\text{AsO}_4^-$ ) while As(III) tends to be uncharged (i.e.,  $\text{H}_3\text{AsO}_3$ ), making it much more difficult to remove from water. Walker et al. (2008) demonstrated that while >95% of As(V) can be removed through reverse osmosis (RO), the removal efficiency was generally <45% when more than 50% of the arsenic exists as As(III). Not only is As(III) unable to be removed through standard arsenic treatment processes, it is also considered more toxic than As(V) (USEPA 2001). Thus, when developing an efficient, cost-effective removal strategy for arsenic from drinking water, it is important to determine both the total concentration and speciation of arsenic.

Previous research based upon thermodynamics shows that As(V) is favored in oxic waters while As(III) is favored in anoxic water (Anderson and Bruland 1991; Mok and Wai 1990; Smedley and Kinniburgh 2002; Welch et al. 1988; Welch et al. 2000). It is also important

to recognize that under natural conditions in a limestone/dolomite aquifer, the oxidation of As(III) into As(V) occurs very slowly due to high bicarbonate concentration (buffer) controlling the pH (Shafer et al. 2007).

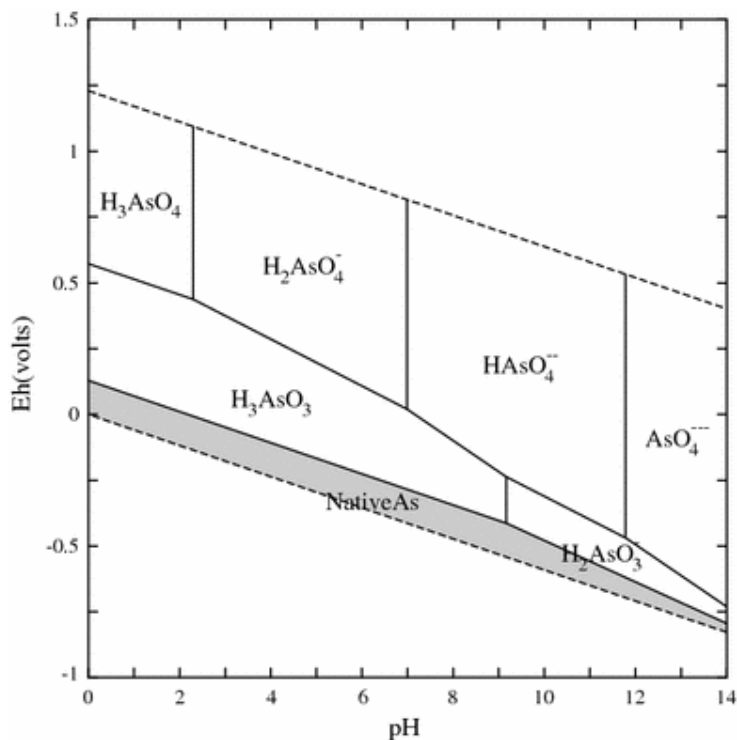
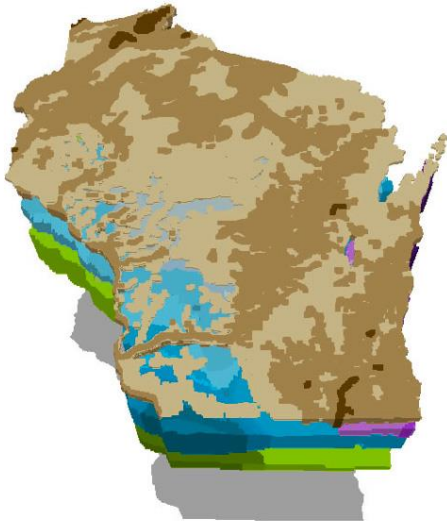

Figure 2. Arsenic Eh-pH Diagram. Reprinted from Lu, P. & Zhu, C. *Environ Earth Sci* (2011)

One study examined spatial variations in arsenic species across the United States, determining that one species of arsenic is dominant (>80% As(III) or As(V)) in nearly all the wells that were sampled (59 out of 65 wells) (Sorg et al. 2013). Of the 65 sites, 31 were dominated by As(V) and 28 were dominated by As(III). The same study showed that As(III) is the primary species in the Upper Midwest, however only one sample was collected in Wisconsin therefore more data is needed to draw a conclusion. The immediate effects of well pumping on arsenic speciation are also unknown prior to this research.

## 1.4 Pleistocene Sand and Gravel Aquifer

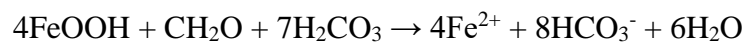

*Figure 3. Sand and gravel aquifer (brown).  
Reprinted from Wisconsin Geological and  
Natural History Survey "Wisconsin Aquifers".*

Arsenic concentrations are dependent on the geologic unit that each well is screened in. In portions of southeastern Wisconsin, many wells are screened in the shallow sand and gravel aquifer. This Pleistocene aquifer is present due to glacier retreat, leaving behind hundreds of feet of aquifer material in some areas (Figure 3). This aquifer is often susceptible to surface contamination due to its proximity to the surface as well as its high permeability. This aquifer also contains natural contaminants, arsenic being one of them. Root et al. (2010) researched the solid-phase geochemistry of this region and determined that the upper portions of the sand and gravel aquifer have between 2-4 mg/kg. Tests were also conducted on the lower portions of this unit and average concentrations between 4-8 mg/kg were detected, with one concentration being 21 mg/kg. Another study conducted in this aquifer showed only 8 out of 136 wells sampled exceeding the EPA MCL for arsenic, with a maximum concentration of 32 ug/L (Root 2005).

### 1.4.1 Release Mechanism

The main mechanism for arsenic release in this aquifer is through microbially mediated reductive dissolution of arsenic-bearing Mn and/or Fe-(hydr)oxides, such as goethite, due to the presence of solid-phase organic matter (Root 2005). The (hydr)oxides incorporate arsenic as an impurity. Reductive dissolution may appear in this aquifer in the following form (Shafer et al. 2007):



Other mechanisms such as diagenesis and desorption are assumed to play a role in the arsenic release, however the combination is difficult to determine due to the complexity of these processes. Although this mechanism readily releases arsenic into the groundwater, it tends not to occur at high levels.

### 1.5 Eastern Silurian Dolomite Aquifer

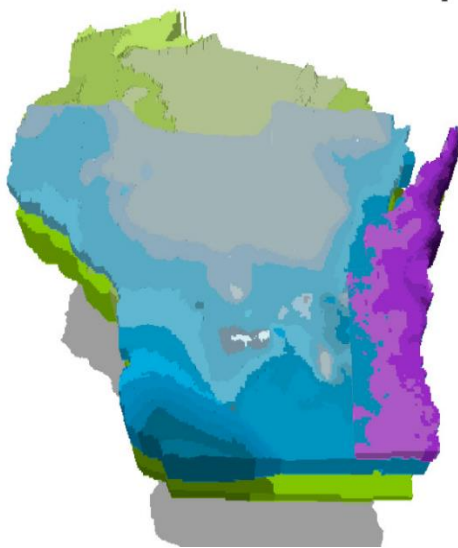
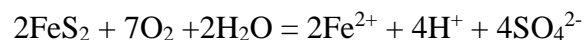

Figure 4. Eastern dolomite aquifer (purple).  
Reprinted from Wisconsin Geological and  
Natural History Survey "Wisconsin Aquifers".

Below the sand and gravel aquifer in Eastern Wisconsin lies a Silurian aquifer comprised of dolomite (Figure 4). This dolomite is dated back to the Middle and Late Paleozoic Era, and the rock in this aquifer was deposited in open and marginal marine environments (Luczaj et al., 2015). This aquifer is thickest in the region that borders Lake Michigan and becomes thinner westward. This dolomite layer and the subsequent underlying layers tend to dip towards the east at approximately 5 to 7 m/km (Luczaj, 2013). This aquifer is underlain by the Maquoketa Shale, an impermeable aquitard which restricts downward groundwater flow to the deeper Ordovician layers. Within the dolomite aquifer, groundwater flows through fractures, pores, vugs, and caves. The level of interconnectedness of these features determines the extent to which the groundwater travels. Due to the spatial variability of these features in the subsurface, groundwater yields vary as well as the presence of source minerals that are responsible for arsenic. The source minerals that contain solid phase arsenic are primarily sulfide bearing minerals such as goethite, pyrite, and marcasite (Figure 5).

### **1.5.1 Release Mechanism**

The release mechanism of arsenic in this aquifer is abiotic oxidative dissolution of the sulfide minerals where arsenic resides as an impurity, represented by the following formula (Shafer et al. 2007):



In situations where oxidative dissolution occurs, oxygen, nitrate, and ferric iron serve as electron acceptors, and positive correlations are anticipated between arsenic, sulfate, metals, and residual elements within the sulfide minerals (Schreiber et al., 2003). Root (2005) sampled 100 wells within this aquifer in Southeast Wisconsin determining that 10 of the wells exceed the EPA

MCL for arsenic, with a maximum concentration of 85 ug/L. Elevated arsenic concentrations in wells installed within this unit often vary from household to household depending on factors such as well depth and proximity to vugs and fractures that contain goethite, pyrite, and marcasite. Because arsenic concentrations often remain around or below the MCL in this aquifer, few studies have pursued this system for arsenic research even as recent data are suggesting growing health concerns.



*Figure 5. Sulfide mineral, pyrite, found in dolomite rock.*

## **1.6 Cambrian-Ordovician Sandstone and Dolomite Aquifer**

Another aquifer which is present throughout much of Wisconsin is the Cambrian-Ordovician sandstone and dolomite aquifer (Figure 6). Alternating layers of sandstone and dolomite make up this aquifer system which was created by alternating shallow and deep marine environments between 443 and 485 million years ago (Luczaj, 2013). A large portion of the

water wells in the state are installed within this aquifer, primarily in the central portion of the state where sandstone dominates the subsurface. Arsenic contamination is a significant concern in portions of East-Central Wisconsin (Fox River Valley), where the Sinnipee dolomite and St. Peter sandstone reach the surface. (Figure 7). Previous work in this region establishes high concentrations of arsenic in a mineralized layer between the Sinnipee dolomite and St. Peter sandstone, termed as the Sulfide Cement Horizon (SCH) (Screiber et al. 2000). The location of the SCH suggests that the mineralization occurred due to the preferential flow of fluids through the top of the sandstone unit. The SCH is found at various depths with various thicknesses, however its stratigraphic position is consistent. Schreiber (2000) conducted rock and mineral analysis on this unit to determine its contents, finding that arsenic is present up to 1% by weight, including some samples that contained greater than 400 mg/kg arsenic.

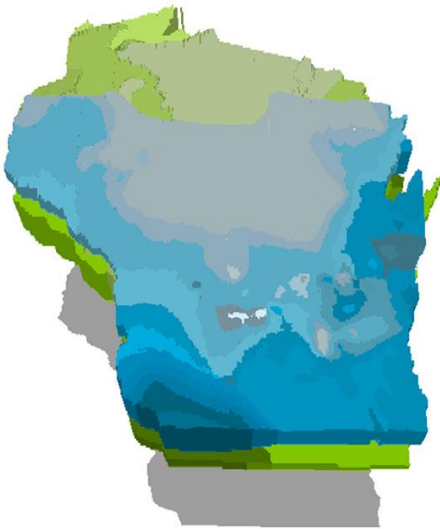

Figure 6. Sandstone and dolomite aquifer (blue).  
Reprinted from Wisconsin Geological and Natural  
History Survey "Wisconsin Aquifers".

### 1.6.1 Release Mechanism

Similar to the eastern dolomite aquifer, the primary mechanism for the release of arsenic from this layer is promoted by abiotic oxidation of the sulfide-bearing minerals. One of the

primary causes for oxidation of this aquifer is by well water usage, resulting in the lowering of the water level. Schreiber (2000) determined that the proximity of the air-water interface to the SCH plays a big role in the concentration of the arsenic in the well water, finding highest concentrations where the air-water interface was within 15m of the SCH. Typically the air-water interface is above the SCH (Figure 8), however during periods of excess pumping, the water level may be drawn below the SCH, introducing oxygen into the system, releasing arsenic. Other forms of oxidation in this unit include regional recharge, vertical leaking, and dewatering (Schreiber et al. 2000). Arsenic concentrations in the Fox River Valley region frequently exceed 100 ug/L, well above the MCL.

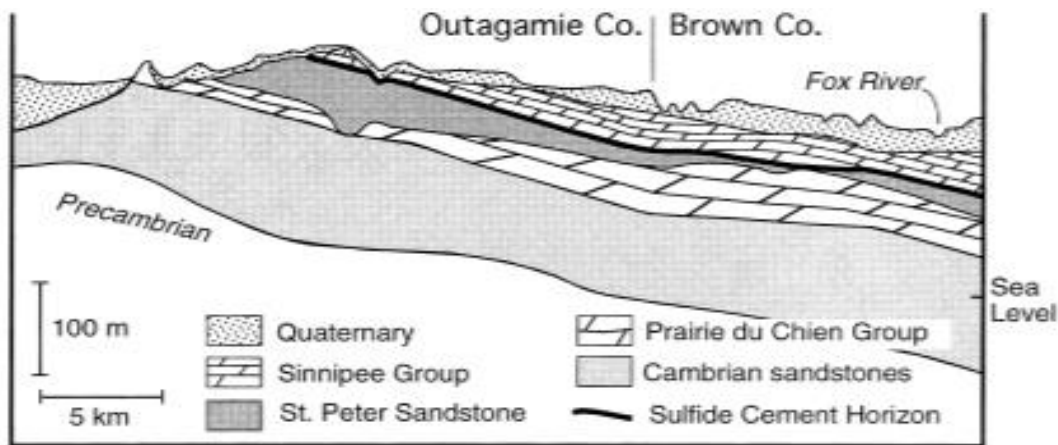

Figure 7. Geologic section showing major units (Schreiber et al. 1999)

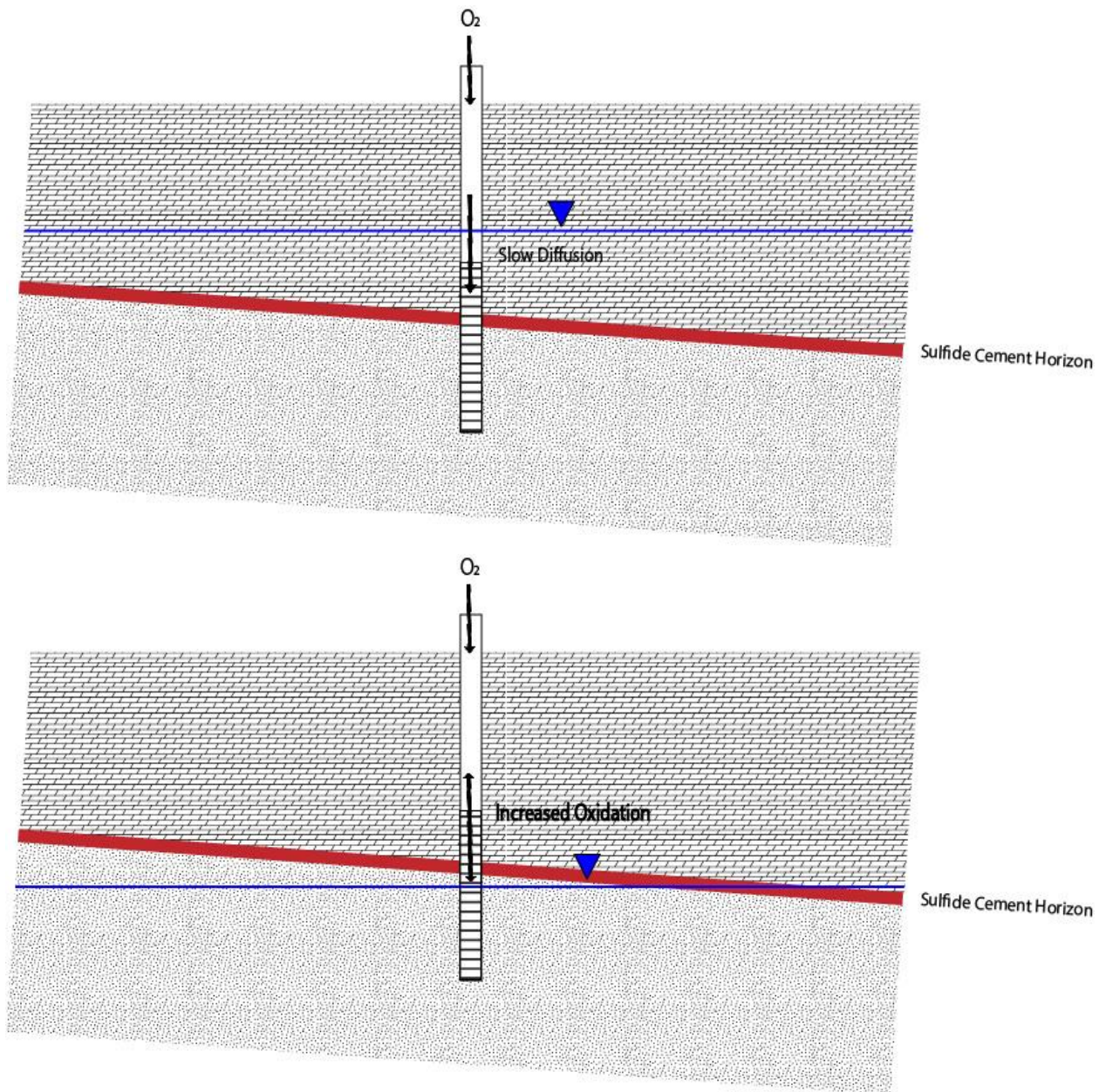

Figure 8. Oxidation of sulfide cement horizon via borehole interaction. Static conditions (top), oxidizing conditions (bottom).

## 1.7 Study Area

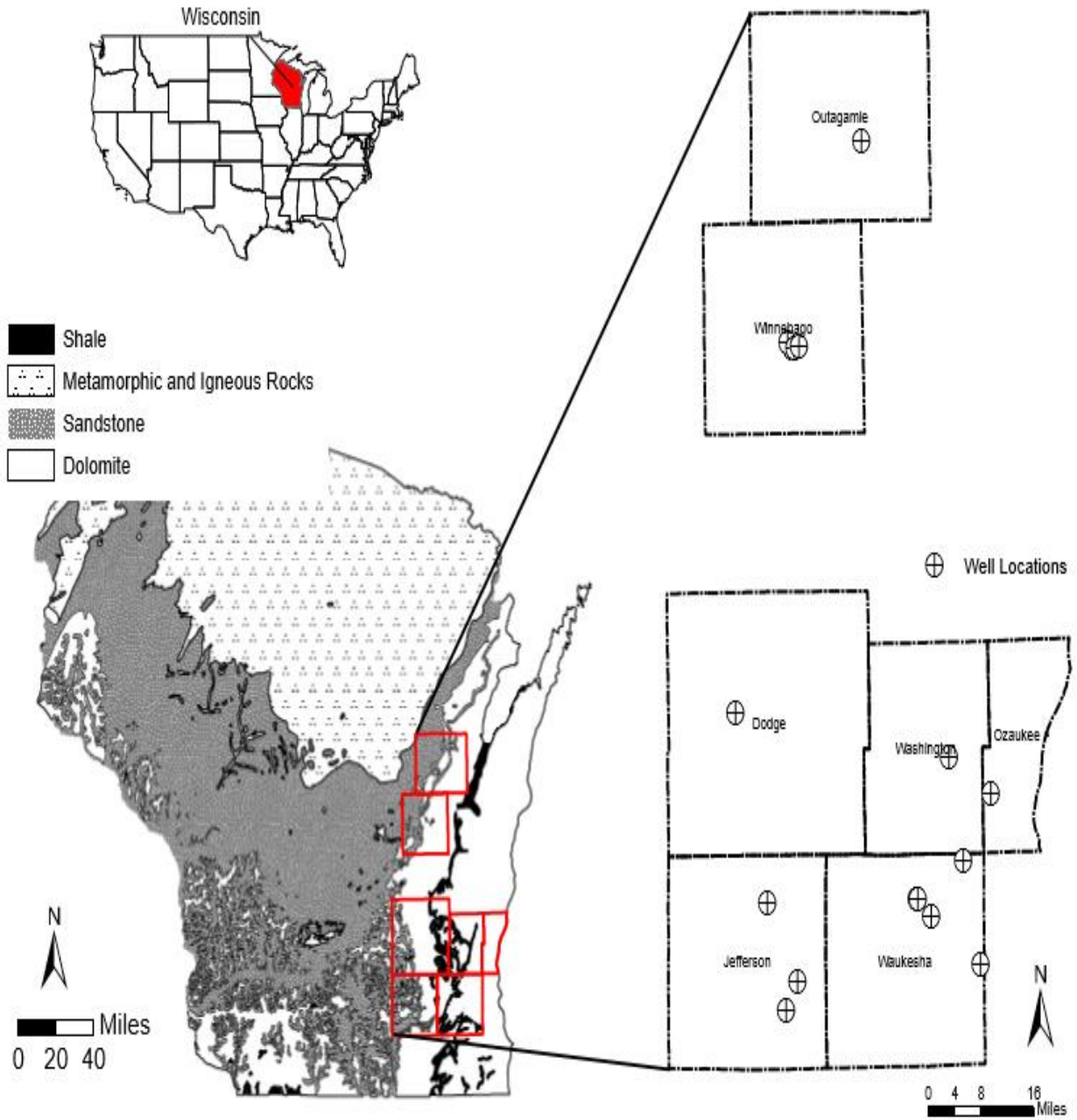

Figure 9. Map of study area. Wisconsin filled in red (top). Wisconsin bedrock map outlining counties in study area in red (left). County map displaying well locations (right).

This study area is located in eastern Wisconsin, encompassing the region with high-risk aquifers. Seasonal trends were established for each well and several wells were selected to undergo pump tests to determine minute-scale variations in arsenic species and total arsenic concentrations. Sixteen private wells will be tested across seven counties, representing the Silurian dolomite aquifer in the eastern counties and the shallower Ordovician dolomite and sandstone aquifer in the western counties (Figure 9).

Table 1. Well locations, aquifers, and screened intervals.

Location ID	County	Aquifer	Depth of Water Extracted (ft)
L1	Waukesha	Dolomite	117-265
L2	Ozaukee	Dolomite	48-120
L3	Washington	Dolomite	234-253
L4	Waukesha	Dolomite	107-228
L5	Dodge	Sandstone (Dolomite Above)	62-129
L6	Jefferson	Dolomite	279-322
L9	Outagamie	Dolomite	65-100
L12	Jefferson	Dolomite	54-56
L13	Waukesha	Dolomite	72-145
L14	Waukesha	Dolomite	77-185
L15	Winnebago	Dolomite/Sandstone boundary	42-142
L16	Winnebago	Dolomite/Sandstone boundary	55-104
L17	Winnebago	Dolomite	43-165
L18	Winnebago	Dolomite/Sandstone boundary	43-80
L19	Waukesha	Dolomite	42-145
L20	Jefferson	Dolomite	51-122

## 1.8 Well Construction Reports

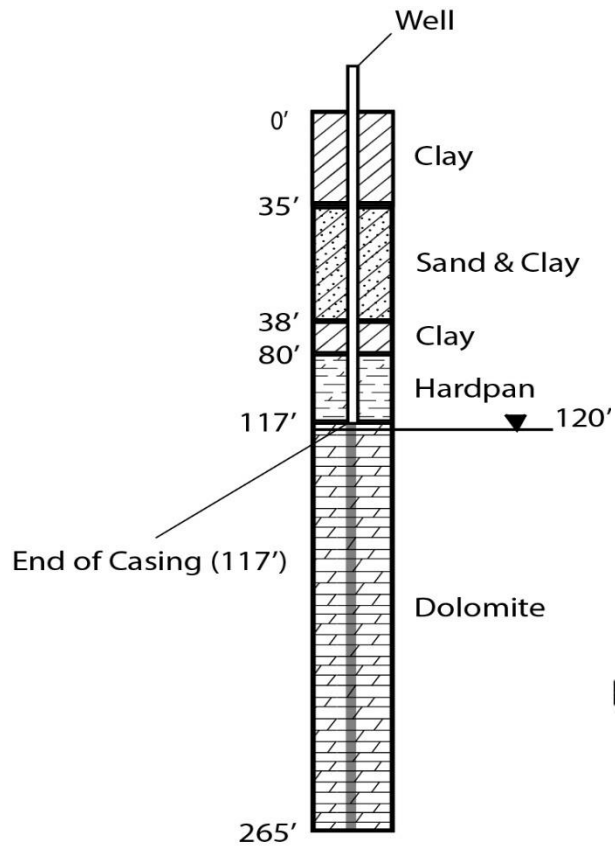

Figure 10. Location L1 well construction report.

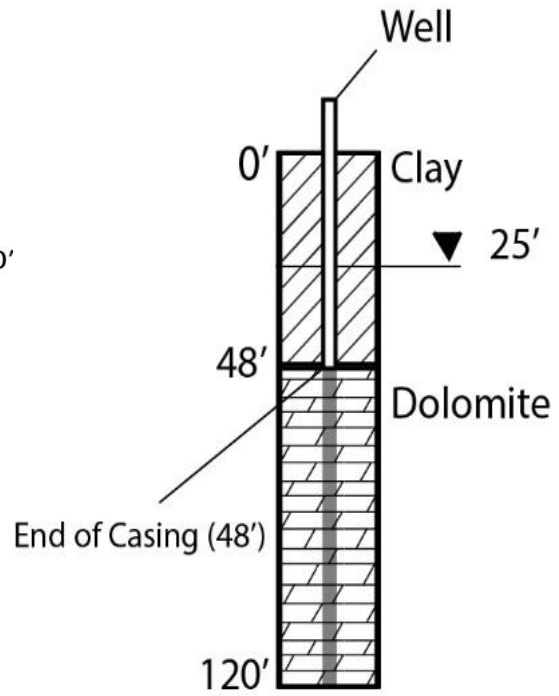

Figure 11. Location L2 well construction report.

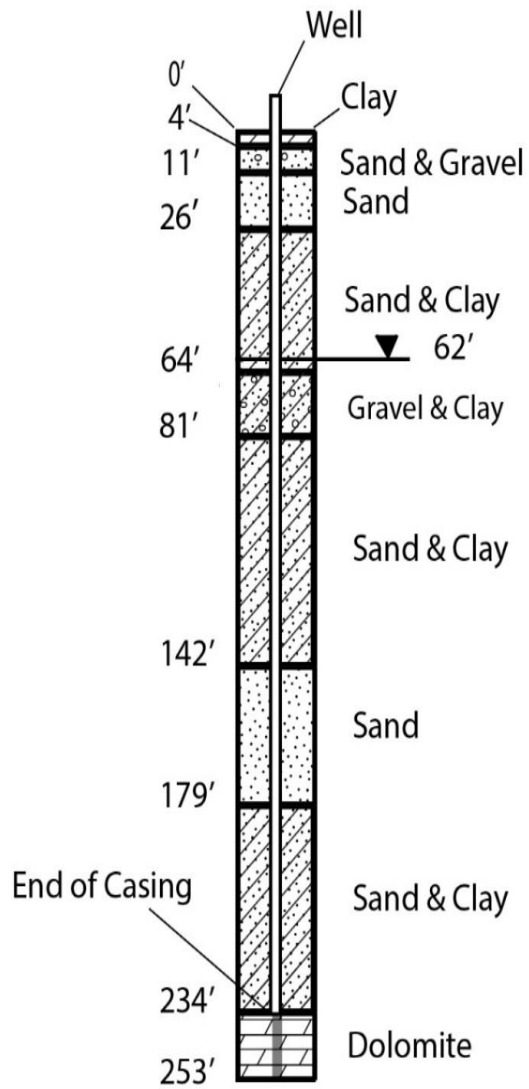

Figure 12. Location L3 well construction report.

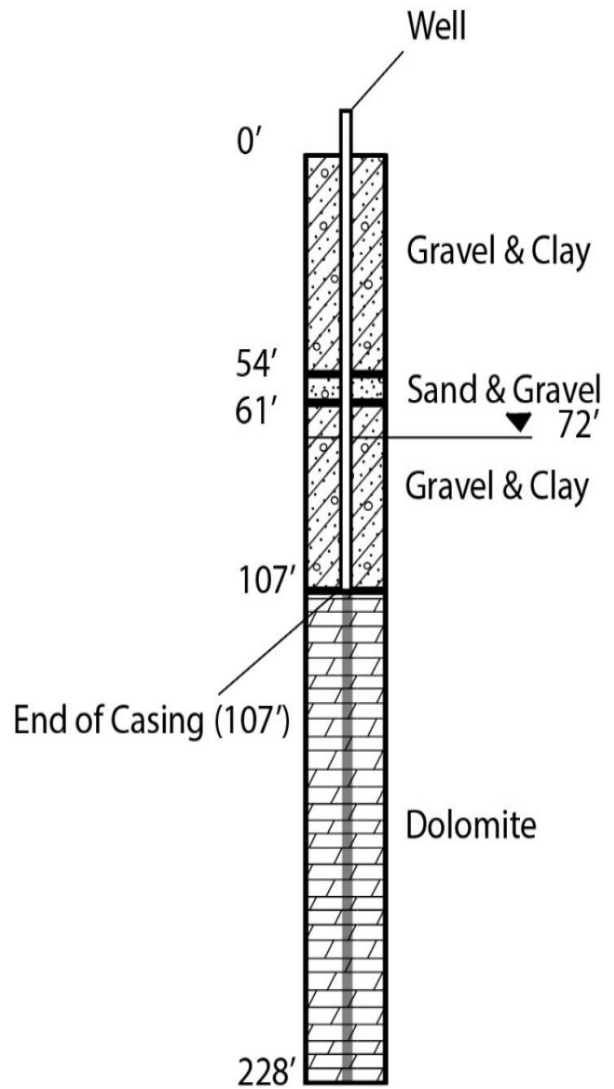

Figure 13. Location L4 well construction report.

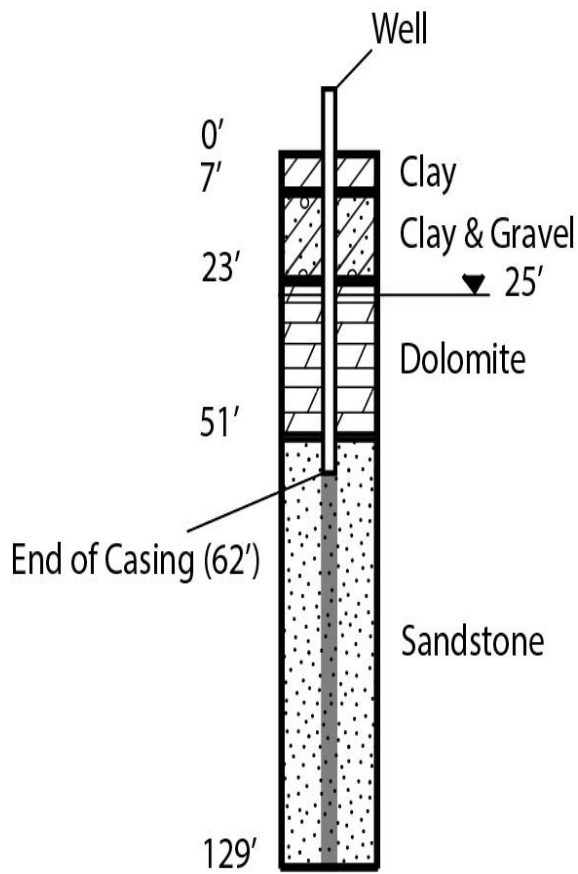

Figure 14. Location L5 well construction report.

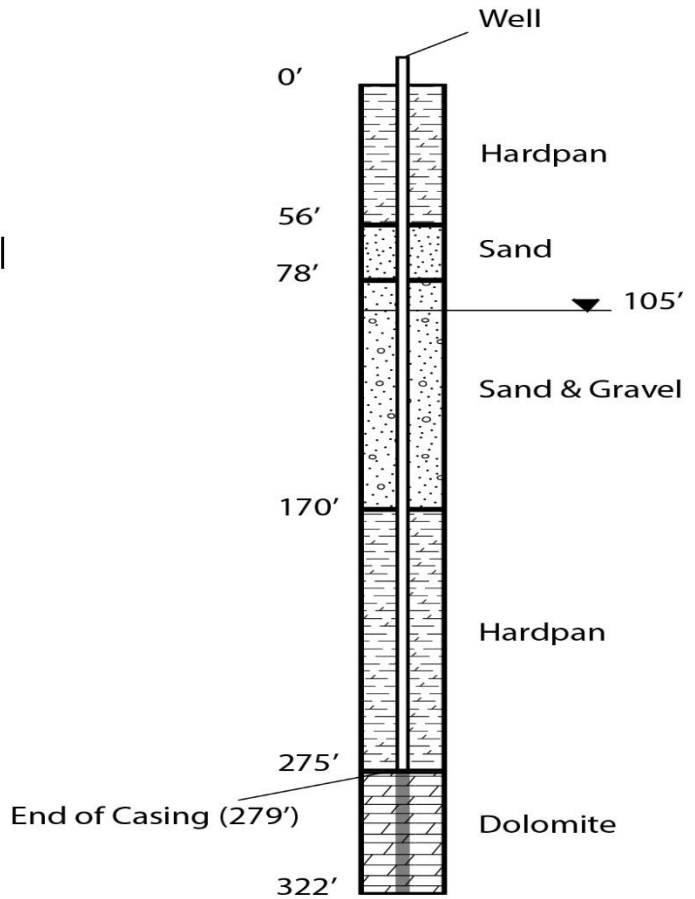

Figure 15. Location L6 well construction report.

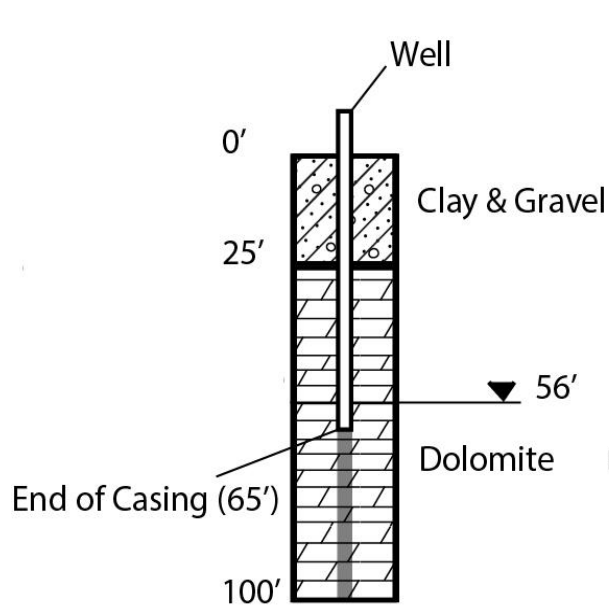

Figure 16. Location L9 well construction report.

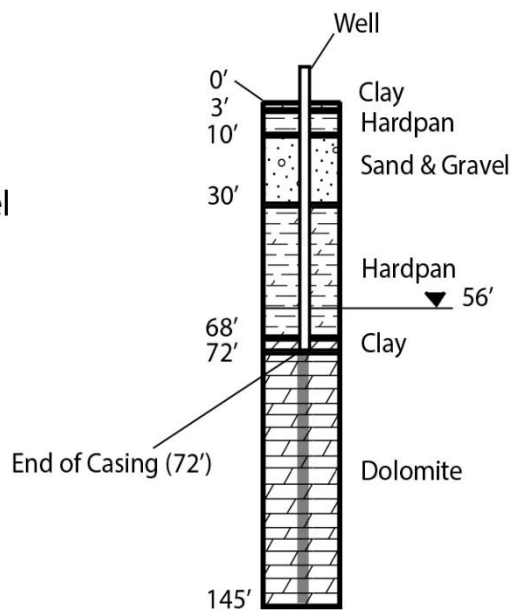

Figure 17. Location L13 well construction report.

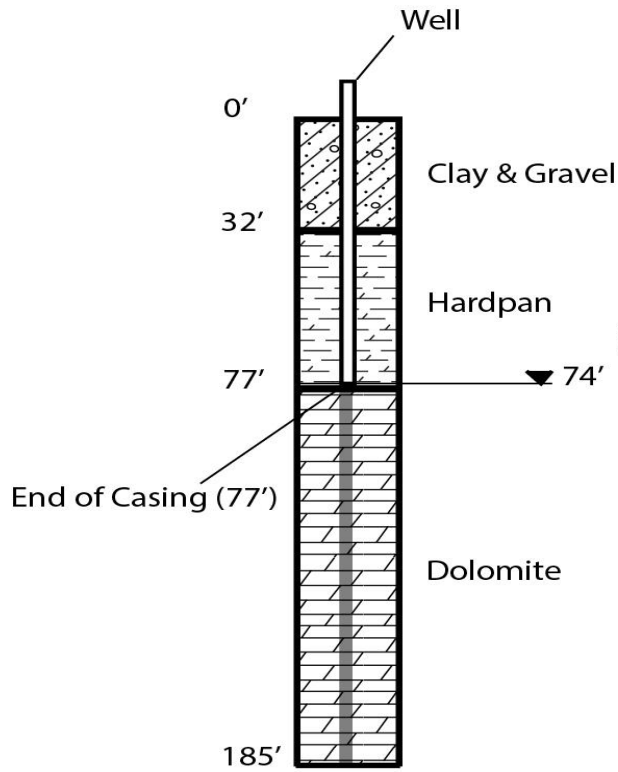

Figure 18. Location L14 well construction report.

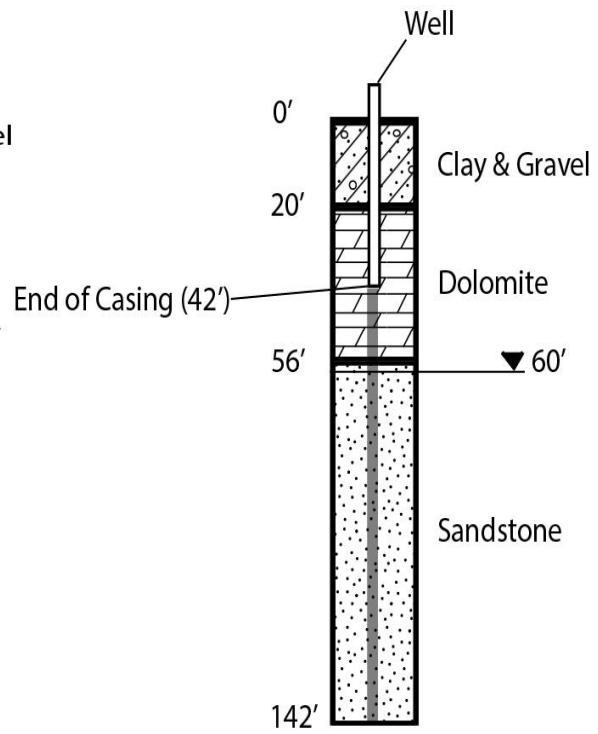

Figure 19. Location L15 well construction report.

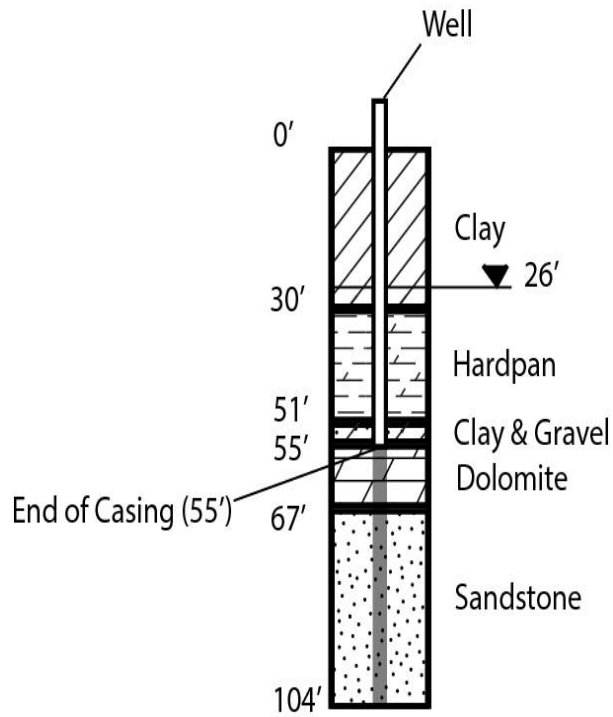

Figure 20. Location L16 well construction report.

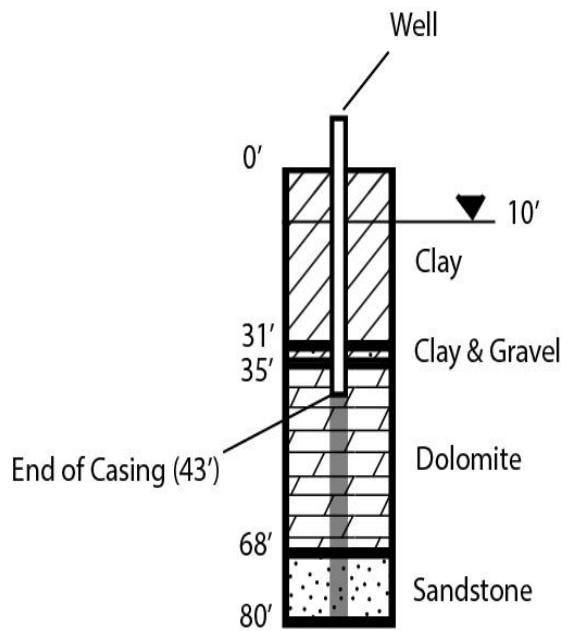
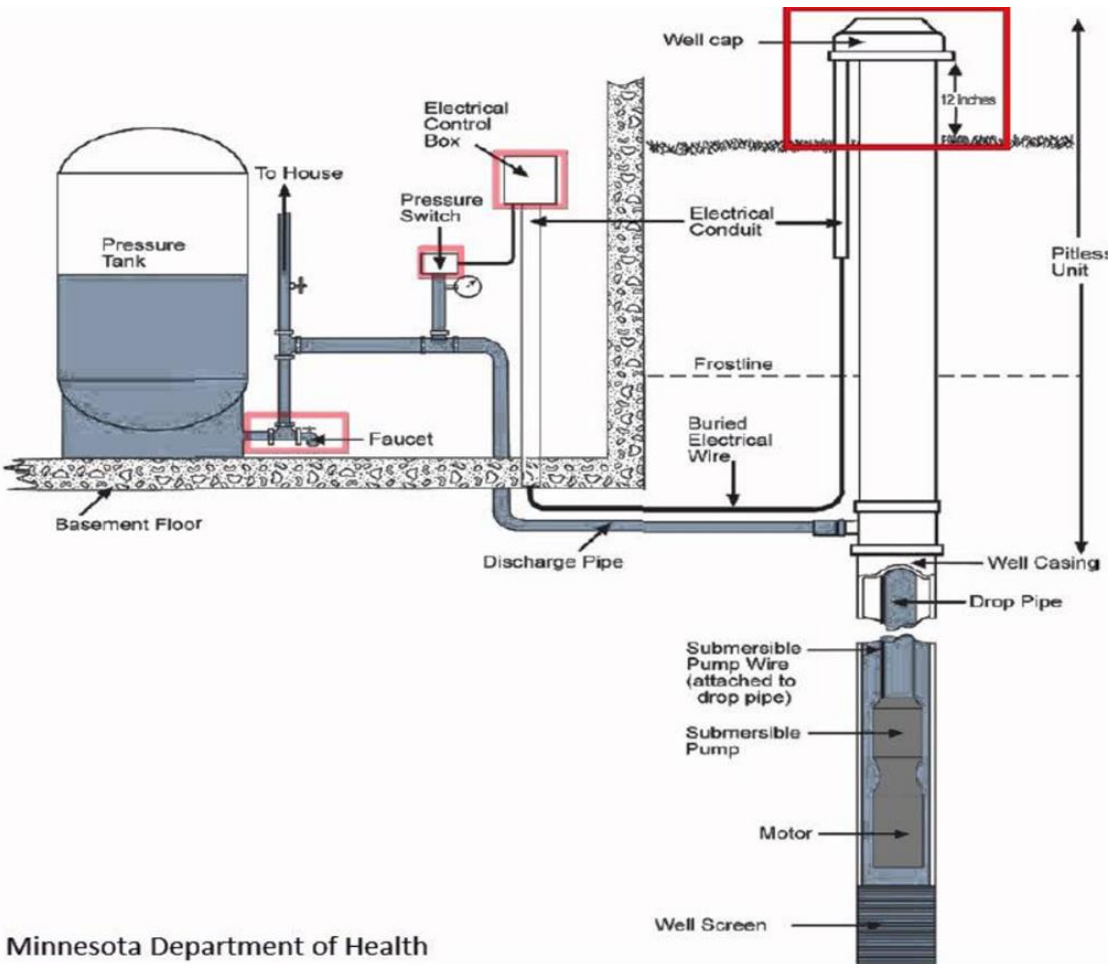

Figure 21. Location L18 well construction report.

## **Chapter 2: Method**

### **2.1 Sampling**

Sample locations were selected using private well data from the Wisconsin DNR of recent arsenic testing. Letters were mailed to homeowners who had high arsenic concentrations and all respondents received testing. Spatial and aquifer variation were sought after in order to provide a good geographical coverage. Sampling events were conducted early in the morning prior to water being used in the household. The first round of sampling events occurred during Wisconsin's winter months (December-March). This sampling event served two purposes: 1) determining the extent of arsenic concentration at each location; and 2) providing the winter concentrations of arsenic. If the well water did not contain arsenic, it was not revisited for a second sampling event. During this sampling event, water was extracted from a spigot, usually located in a building's basement, directly linked to the well. The water that arrived at the spigot was unaltered by any household filtration systems and was most representative of the water at the bottom of the well. The spigot was opened, allowing the water from the holding tank to empty and samples were collected once the pump began to run. The water samples were collected in 250 mL, unpreserved, polyethylene bottles. The bottles were filled to the brim, not allowing any oxygen to interact with the sample during travel to the lab (see preservation). Water quality parameter, including pH, temperature, conductivity, and total dissolved solids (TDS) were determined during this event using a calibrated YSI Professional Plus multiparameter instrument.



Minnesota Department of Health

Figure 22. Well Diagram. Reprinted from Minnesota Department of Health "Well Owner's Handbook".

During the first sampling event, water was also tested inside the household from whatever water purification systems were installed. This was done in order to get a better understanding of how the water quality parameters, cations and anions, as well as arsenic concentrations and species were altered by these purification processes. The systems that were in place included: water softeners, carbon filtration, reverse osmosis systems, and in some cases no filtration at all. Results were provided to the homeowners and recommendations were discussed to limit arsenic exposure.

The second round of sampling occurred over the summer months (May-September) to account for seasonal trends. During this second event, 10 of the wells were pumped to determine

how arsenic concentrations changed. The samples collected during the summer event were obtained from an outdoor hose which was also directly linked to the well, without any form of filtration (Figure 22). During this sampling event, field measurements tested for included: pH, temperature, conductivity, and oxidation reduction potential (ORP) using the YSI field instrument (Figure 23)



*Figure 23. Measuring field parameters using YSI Professional Plus multiparameter instrument at location L3.*



Figure 24. 1-hour pump test at location L9.



Figure 25. 1-hour pump test at location L2.

A third round of sampling was conducted at locations L5 and L6 based upon data analysis of arsenic concentrations. Water was collected similarly to the second round of sampling however another aspect was added: sampling during the period after pumping has ceased. Field measurements remained the same as the second sampling event. Locations L5 and L6 were re-sampled a fourth time, similarly to the third round of sampling, to demonstrate reproducibility. The one field parameter that was added during the fourth round of sampling was sulfide.

## **2.2 Pumping**

The wells from locations L1, L2, L3, L5, L6, L9, L15, L16, and L18 were pumped for 1 hour during the second round of sampling. The pumping rates varied at each location, anywhere from 4 gallons per minute to 15 gallons per minute. Flow rates were determined by timing how long it takes to fill up a 5-gallon bucket. These tests resulted in volumes between 240 and 900 gallons pumped from the wells over 1 hour. Similar to the winter sampling event, the first sample was collected after the water was removed from the holding tank. Samples were then collected every 20 minutes throughout the duration of pumping. During the third round of sampling, samples were collected initially, after 30 minutes, and after 60 minutes of pumping. After pumping ceased, samples were collected at 20 minutes, 40 minutes, and 180 minutes at Location L5, and 20 minutes, 40 minutes, and 90 minutes at Location L6. To ensure that the water was not re-disturbed during this portion of sampling, the hose was only turned on long enough to obtain the sample and water quality measures. During the fourth round of sampling, samples were collected at location L5 and L6 similarly to the third sampling event at location L5 (i.e. initially, 30, and 60 minutes, followed by 20, 40, and 180 minutes post pumping). A fifth pumping event was conducted at location L6 to determine if arsenic concentrations changed if pumping continued throughout the span of 4 hours.

## 2.3 Preservation

Field preservation of samples was considered but not implemented throughout all steps of this experiment. Common practice for arsenic preservation in water samples based upon EPA guidelines is to collect the water in a plastic bottle that is preserved with nitric acid, such that the pH of the water sampled will drop below 2 (EPA 2016). Using this method, the arsenic will remain in solution for approximately 6 months. This method was ignored due to complications with the arsenic speciation method. The arsenic speciation method is most effective when the pH of the water is approximately 6. Due to the conflict, ‘trip blanks’ were established to determine if arsenic concentrations and speciation’s changed from the time that the groundwater was sampled until it was preserved in the lab.

The furthest distance that a sample was collected from the lab was 105 minutes of drive time. Thus, two batches of synthetic solutions were created, the first of which was analyzed for arsenic immediately. The second batch (same solution) was held for 120 minutes prior to analysis, which simulated the furthest return drive time to the lab (plus 15 minutes). These ‘trip blanks’ consisted of synthetic arsenic mixtures consisting of roughly 50% As(III) and 50% As(V) at concentrations of 5 ug/L, 10 ug/L, 20 ug/L, and 100 ug/L total arsenic. Based upon previous research of arsenic species in groundwater, most aquifers contain some percentage of each species of arsenic (Sorg et al., 2013), which is why these equal mixtures were proposed. The concentrations of the total arsenic coincide with arsenic data that was previously received from the WDNR. The percent differences in arsenic speciation from this experiment are shown in Table 2. It was established that the changes in arsenic speciation within a 120-minute timeframe are negligible (less than 2%) and that we can proceed without field preservation of

nitric acid preservation. The only field preservation measure that was implemented with the water samples upon collection was that they were placed in a cooler with ice (< 4°C).

Table 2. Trip blank tests using 50:50 mixtures of As(III) and As(V) species. Red outline denotes % change during trip.

Source	As 3 (ug/L)	As 5 (ug/L)	As Total (ug/L)	As 3%	As 5%	% Difference (Speciation)	% Δ Speciation (In. – Final)
Initial (100 ug/L)	55.16	59.80	114.96	47.98	52.02	4.04	--
Initial (20 ug/L)	11.93	11.39	23.32	51.15	48.85	2.30	--
Initial (10 ug/L)	6.43	5.34	11.77	54.65	45.35	9.29	--
Initial (5 ug/L)	3.53	2.40	5.94	59.51	40.49	19.02	--
Final (100 ug/L)	59.81	66.70	126.51	47.27	52.73	5.45	1.41
Final (20 ug/L)	13.03	12.70	25.73	50.63	49.37	1.27	1.03
Final (10 ug/L)	6.95	5.94	12.89	53.94	46.06	7.87	1.42
Final (5 ug/L)	3.93	2.51	6.44	60.96	39.04	21.92	2.90

## 2.4 Ion Determination

### 2.4.1 Field Measurements

Determining iron concentrations in the field was necessary as concentrations between ferrous and ferric iron tend to shift readily when exposed to oxygen. These measurements were made using a Hach DR900 multiparameter portable colorimeter. Ferrous iron reagent powder pillows and Ferrover iron reagent powder pillows were used according to Hach methods 8146 and 8008, respectively. The Ferrover iron reagent powder pillows were used to determine the total iron in solution. To determine the amount of ferric iron, the total ferrous iron concentration was subtracted from the total iron concentration. Iron concentrations were measured throughout the second, third, and fourth sampling events during every period of pumping (initial, 20, 30, 40,

and 60 minutes) as well as during the post-pumping periods (20, 40, 90, and 180 minutes). The alkalinity of the initial water samples was quantified through acid titration using a Hach digital titrator test kit using Hach method 8203. This measurement was also conducted in the field as the carbonate ion concentrations would not be representative if exposed to air or agitated excessively. Sulfide concentrations were determined in the fourth round of sampling during each period of pumping (initial, 30, and 60 minutes) as well as during the post-pumping periods (20, 40, 60, 90, and 180 minutes) according to Hach method 8131.

#### **2.4.2 Lab Measurements**

Other major ions were quantified at the School of Freshwater Sciences lab (SFS) at the University of Wisconsin – Milwaukee (UWM). Unpreserved water samples from every sampling period were returned to the lab where they were filtered with a 0.22-micron filter and acidified using 2% optimum nitric acid ( $\text{HNO}_3$ ) in preparation for major cation analysis. Calcium, magnesium, potassium, and sodium were determined from these water samples using an iCE 3300 AAS Atomic Absorption Spectrometer. Water samples were also filtered with a 0.22-micron filter in preparation for major anion analysis (chloride, nitrate, phosphate, and sulfate). Major anions were determined using HPLC equipped with a conductivity detector (Xu et al., 2004).

#### **2.5 Arsenic Determination**

Arsenic concentrations were determined using inductively coupled plasma mass spectrometry (ICP-MS) following the EPA standard method 200.8 (USEPA, 1994). An anion-exchange method modified from previous studies (Wang and Giammar, 2015; Wilkie and

Hering, 1998) was used for separation of As(III) and As(V). Briefly, anion-exchange resin (AG 1-X8 from Bio-Rad, 100 – 200 mesh) was first converted to an acetate form via sequential equilibration with 1 M of NaOH and 1 M of acetic acid. One gram of resin was then wet-packed in chromatography columns (BioRad). An aliquot of a groundwater sample was adjusted to a pH of 6 and passed through two columns of anion-exchange resin (Figure 26).

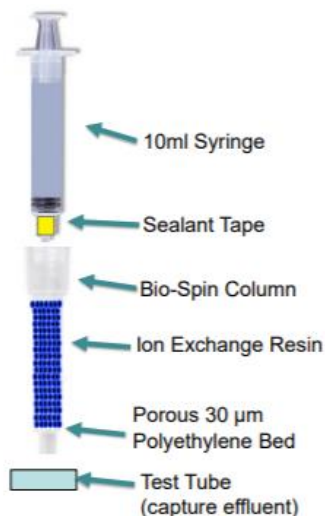

Figure 26. As(III) & As(V) separation process (Trujillo, D., & Wang, Y. 2018)

At a pH of 6, As(V) is primarily present as an anion (i.e.,  $\text{H}_2\text{AsO}_4^-$ ), while As(III) is not charged (i.e.,  $\text{H}_3\text{AsO}_3$ ). Thus, neutral As(III) species pass through the column, and anionic As(V) species are retained. Samples before (influent) and after (effluent) column separation were acidified to 1 – 2%  $\text{HNO}_3$  for determination of total As and As(III) concentrations, respectively. As(V) concentration were determined as the difference between total As and As(III). This method was validated using a standard addition test of As(III), As(V), and mixtures of As(III) and As(V) samples with predetermined concentrations (Figure 27-28).

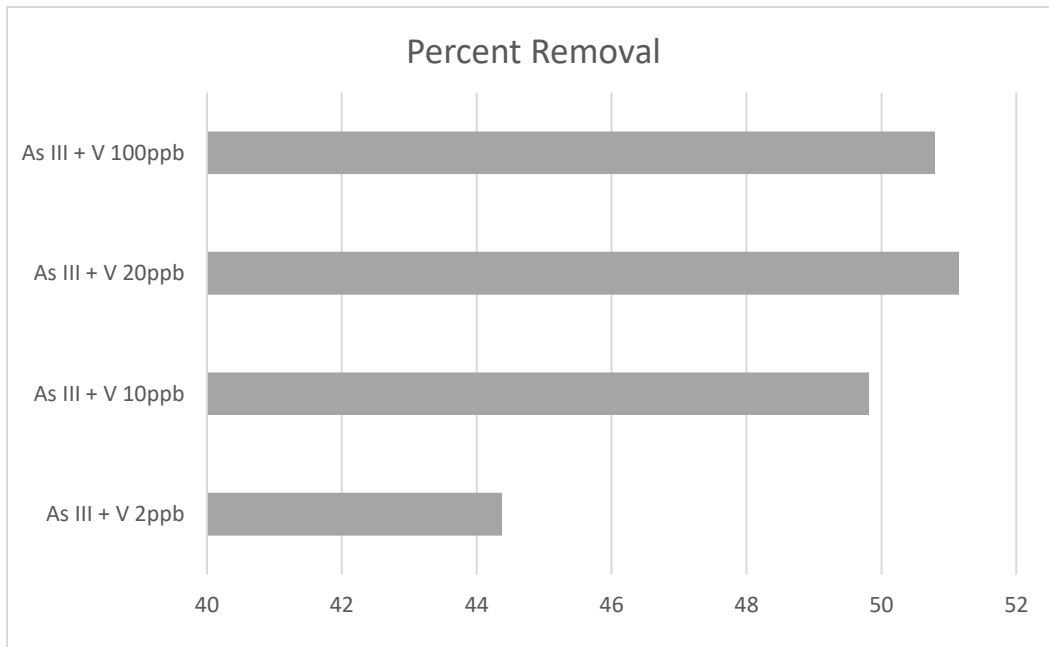

Figure 27. Removal efficiency of ion exchange resin (50:50 species solutions)

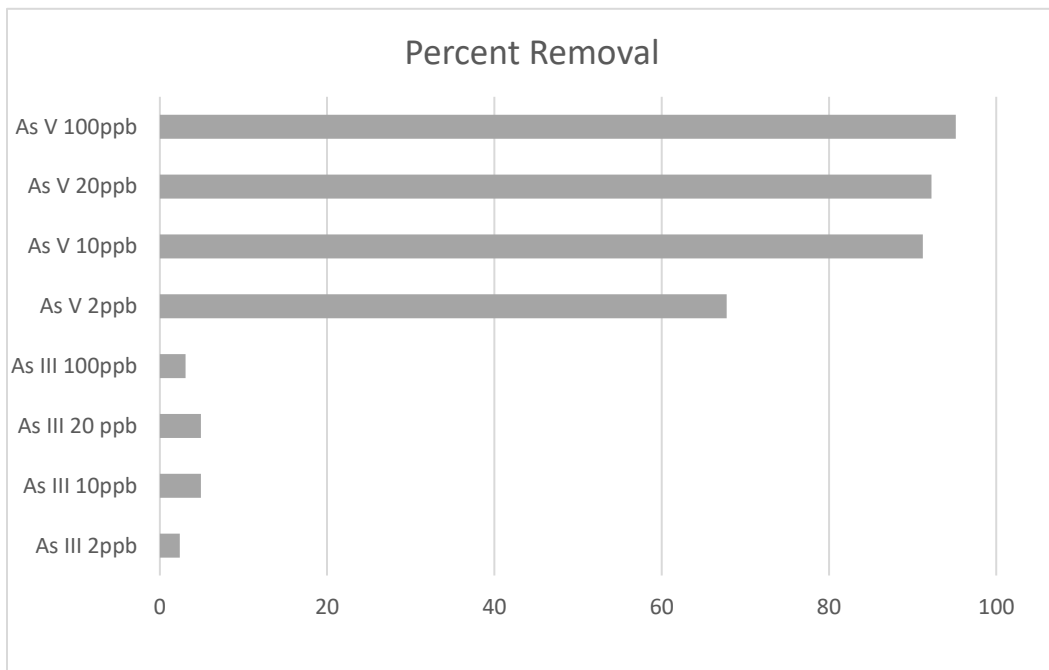

Figure 28. Removal efficiency of ion exchange resin (Individual species solutions).

The analysis of laboratory samples will involve both experimental and analytical quality assurance (QA)/quality control (QC) checks. Experimental checks include the collection of

laboratory blanks and replicate samples. Analytical QA/QC checks include instrument calibration, check standards, and method blanks. Internal standard will be spiked to each sample before injection to address the instrumental variation. Groundwater samples were also sent to other laboratories for sample confirmation.

## Chapter 3: Results and Discussion

### 3.1 All Locations

#### 3.1.1 Total Arsenic

Table 3. Water quality measures and total arsenic concentrations at 16 well locations during winter sampling events.

Location ID	Date Sampled	pH	Conductivity (us/cm)	Temperature (°C)	TDS (ppm)	Alkalinity (mg/L)	Arsenic (ug/L)
L1	12/20/2018	7	910	14.3	457	214	9.27
L2	1/10/2019	7	787	12	397	354	9.00
L3	1/17/2019	7	500	11.4	254	206	6.80
L4	1/19/2019	7	794	12.3	398	--	2.96
L5	2/9/2019	6.5	625	13.3	311	344	14.25
L6	1/31/2019	6.5	655	10.1	330	336	21.13
L9	2/28/2019	6.5	551	11.1	278	373	39.77
L12	2/7/2019	6.5	939	11.6	473	--	0.24
L13	3/1/2019	7	1087	11.8	548	--	8.05
L14	3/1/2019	6.5	707	12.3	352	--	12.74
L15	6/30/2019	6.5	696	11.6	352	379	764.83
L16	3/15/2019	6.5	945	12.4	485	388	17.80
L17	3/18/2019	6.75	1113	11.5	569	--	0.11
L18	3/18/2019	6.75	725	12.4	363	307	51.17
L19	3/19/2019	6.75	1280	12.2	638	--	0.20
L20	4/26/2019	7	647	12.6	325	--	0.51

The water quality field parameters as well as arsenic concentrations from the first round of sampling events are found in (Table 3). Of the 16 private wells that were sampled in the first round, 7 wells exceeded 10 ug/L As, 4 wells contained between 5 ug/L and 10 ug/L As, and 5 wells had concentrations less than 5 ug/L As. Of the wells that exceeded 10 ug/L, one well

contained 764.83 ug/L arsenic, >75 times larger than the EPA MCL. The wells that contained less than 5 ug/L (L4, L12, L17, L19, and L20) were not revisited for a second sampling event due to the insignificant arsenic concentrations.

### 3.1.2 Speciation

Table 4. Seasonal arsenic speciation at 11 well locations.

Location ID	Winter Sampling Event			Summer Sampling Event		
	As(III) %	As(V) %	Total As (ug/L)	As(III) %	As(V) %	Total As (ug/L)
L1	74.8	25.2	9.3	91.1	8.9	10.8
L2	76.2	23.8	9.0	100.0	0.0	9.5
L3	76.9	23.1	6.8	83.8	16.2	7.7
L5	73.5	26.5	14.3	94.5	5.5	13.6
L6	88.8	11.2	21.1	90.8	9.2	19.0
L9	82.4	17.6	39.8	81.9	18.1	39.5
L13	79.0	21.0	8.0	100.0	0.0	9.3
L14	45.6	54.4	12.7	62.3	37.7	10.9
L15	85.7	14.3	764.8	65.8	34.2	618.9
L16	81.9	18.1	17.8	91.4	8.6	17.8
L18	80.3	19.7	51.2	87.6	12.4	44.4
Average	76.8	23.2	86.8	86.3	13.7	72.9

Sample locations that were visited twice (winter and summer), due to elevated arsenic concentrations, were included in (Table 4). During the winter sampling events, 10 out of 11 of the wells were dominated by As(III) while in the summer all 11 wells were dominated by As(III). During the winter, the average percent As(III) species was 76.81% while in the summer the average increased to 86.29% As(III). Location L14 was the only well that exhibited dominated As(V) species during all sampling events. The only well that showed a decrease in As(III) percentage from winter to summer was location L15, which also exhibited the highest arsenic concentrations during all tests.

### 3.1.3 Geologic Units

Many of the wells that were utilized in this study had accessible well construction reports that were used to determine well depth, and USGS data was used to determine the approximate surface elevation of the well. This data was collected in order to determine if there is a correlation between median screen height of a well above sea level and the corresponding arsenic concentrations. The wells were partitioned into their respective aquifer type to get a better understanding for each system.

### Elevation vs Arsenic Concentration

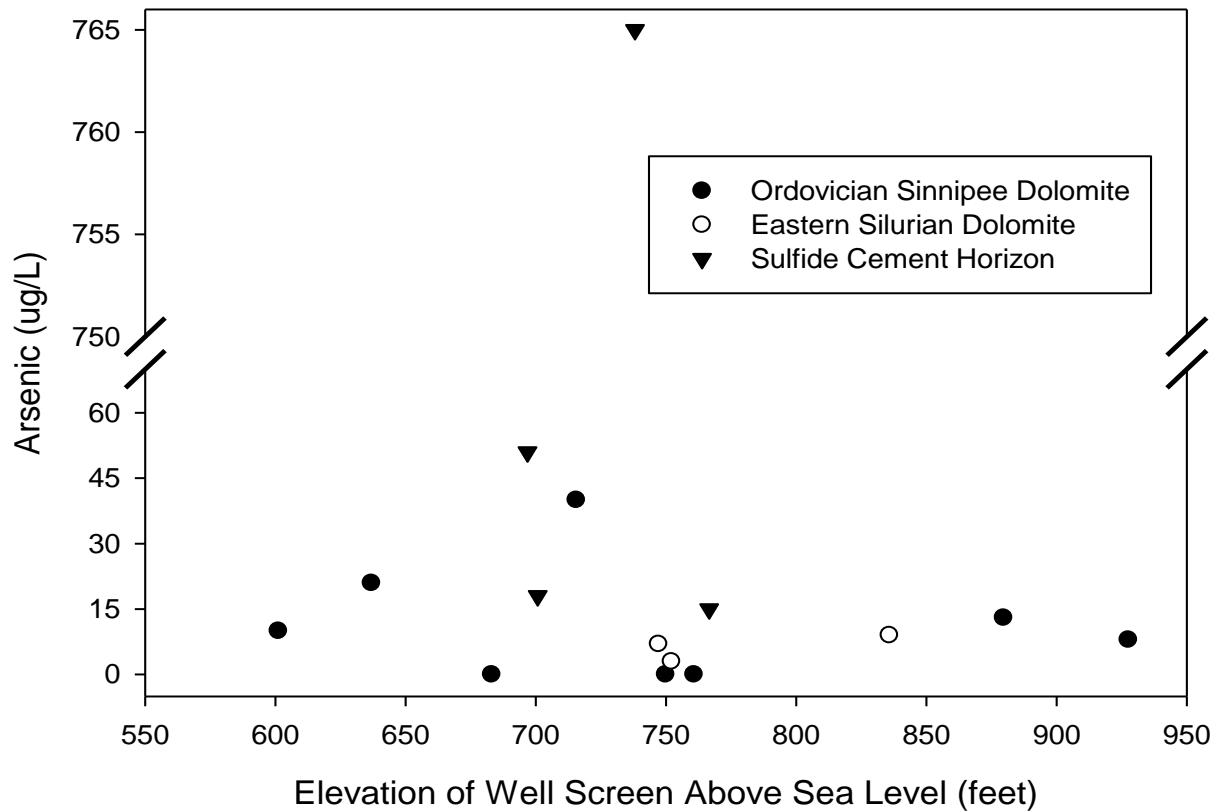

Figure 29. Elevation & geologic unit of well screens vs total arsenic concentration.

There did not appear to be a strong correlation between well height and arsenic, however slightly higher concentrations were found in wells that were screened between about 625-775

feet above sea level. The wells that had highest arsenic concentrations were screened at or near the sulfide cement horizon. Wells screened within the Ordovician, Sinnipee dolomite appeared to have the greatest variation in values, some being insignificant and one approaching 40 ug/L arsenic. The wells that were screened within the eastern Silurian dolomite did not contain very high concentrations, however all contained values at or near the EPA MCL.

### **3.2 Group 1: Substantial Arsenic Increase**

Wells were subdivided into groups based upon relative increases in arsenic concentration during the one-hour pump tests. Group 1, which are the wells that had the most substantial arsenic increase (>15 ug/L), consists of well locations L5, L6, and L15. Wells L5 and L15 were presumably drawing water from at or near the SCH, while L6 was drawing water from the Sinnipee dolomite, near the SCH. Pump tests were conducted on wells L5 and L6, 3 and 4 times, respectively, and well L15 once (Figures 30-32).

Well L5 displayed a trend in which arsenic concentrations increased substantially throughout the first 200 gallons of pumping and then appeared to level off or even decrease towards the conclusion of the test. This trend was consistent across all three pump tests, with the August test displaying the lowest concentration variations and the October test displaying the greatest variations. The most substantial increase in arsenic (October) was 27.93 ug/L after 180 gallons of pumping (30 minutes).

Well L6 exhibited a trend in which arsenic concentrations increased consistently throughout the 1-hour, 300-gallon pump test, and never appeared to level out. Consistent with

## Location L5 Pump Tests vs Arsenic

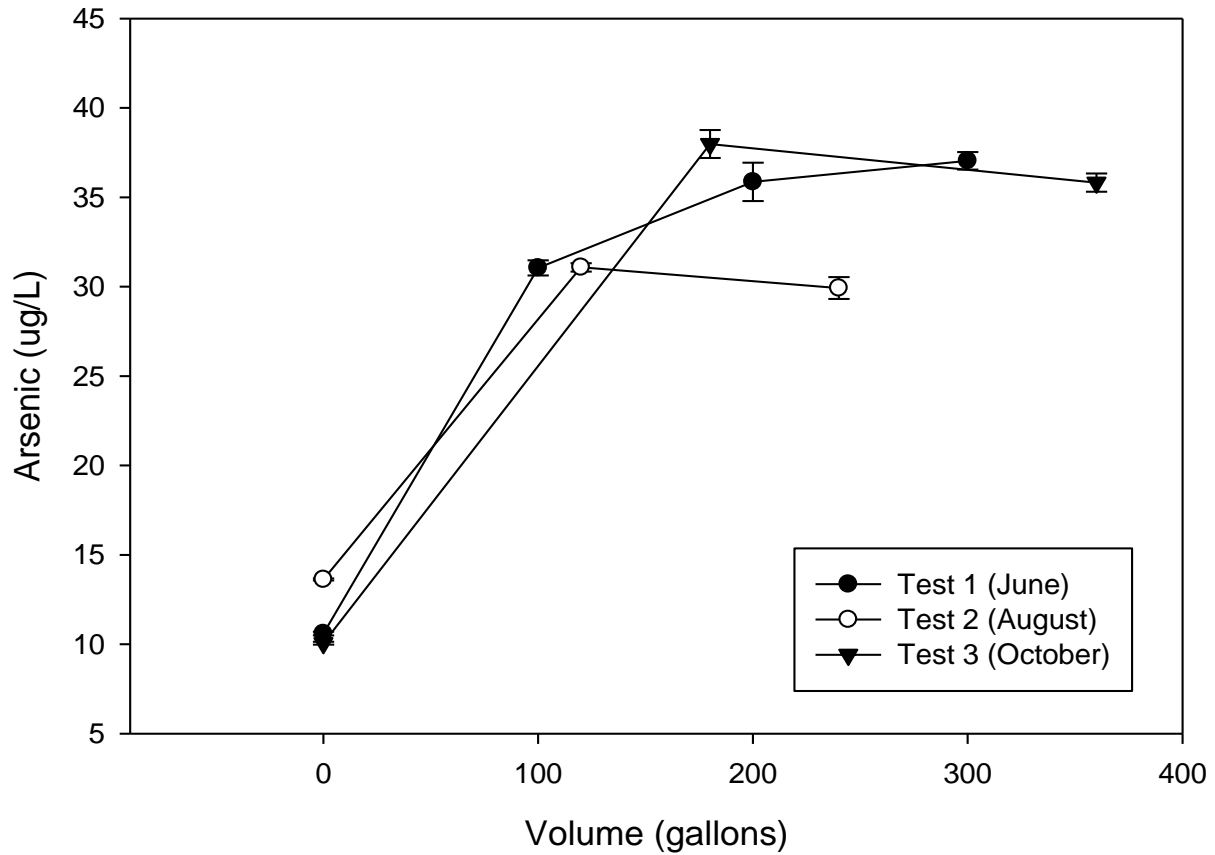

Figure 30. Three pump tests conducted at location L5. Comparing volume pumped (gallons) to total arsenic concentration (ug/L).

well L5, well L6 had the greatest variations in arsenic concentrations in October, and the lowest variations in June. The most substantial increase in arsenic (October) was 15.64 ug/L after 300 gallons of pumping (1-hour). The release mechanism responsible for total arsenic in well L6 appears to be occurring at a slower rate than that of well L5.

Well L15 exhibited a trend unlike wells L5 and L6, in which total arsenic concentration decreased substantially (218.79 ug/L) during the first 20 minutes (80 gallons) of pumping. Following the initial decrease, arsenic concentrations began to increase as the test continued,

120.87 ug/L for the remaining 40 minutes (160 gallons) of pumping. The release mechanism in well L15 is much more sensitive to pumping than that of wells L5 and L6.

### Location L6 Pump Tests vs Arsenic

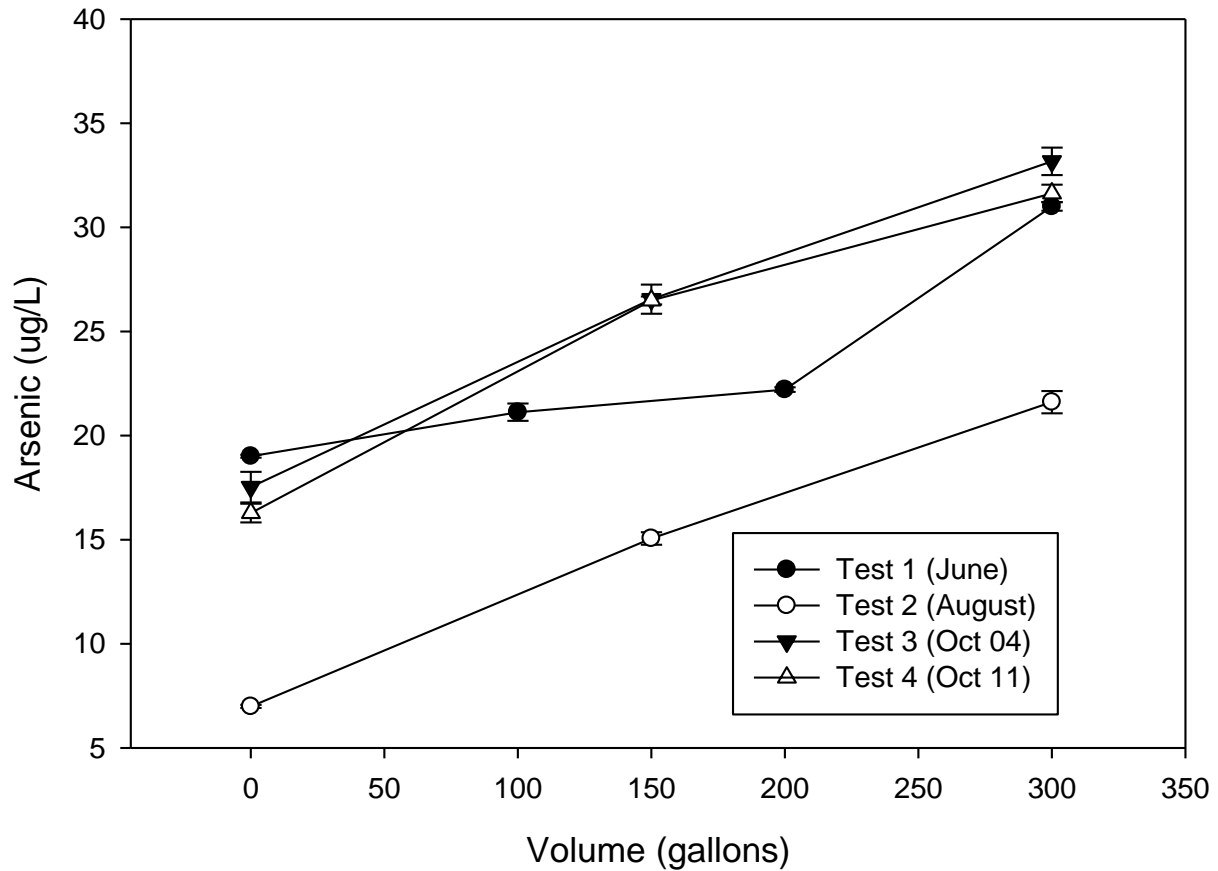

Figure 31. Four pump tests conducted at location L6. Comparing volume pumped (gallons) to total arsenic concentration (ug/L).

## Location L15 Pump Test vs Arsenic

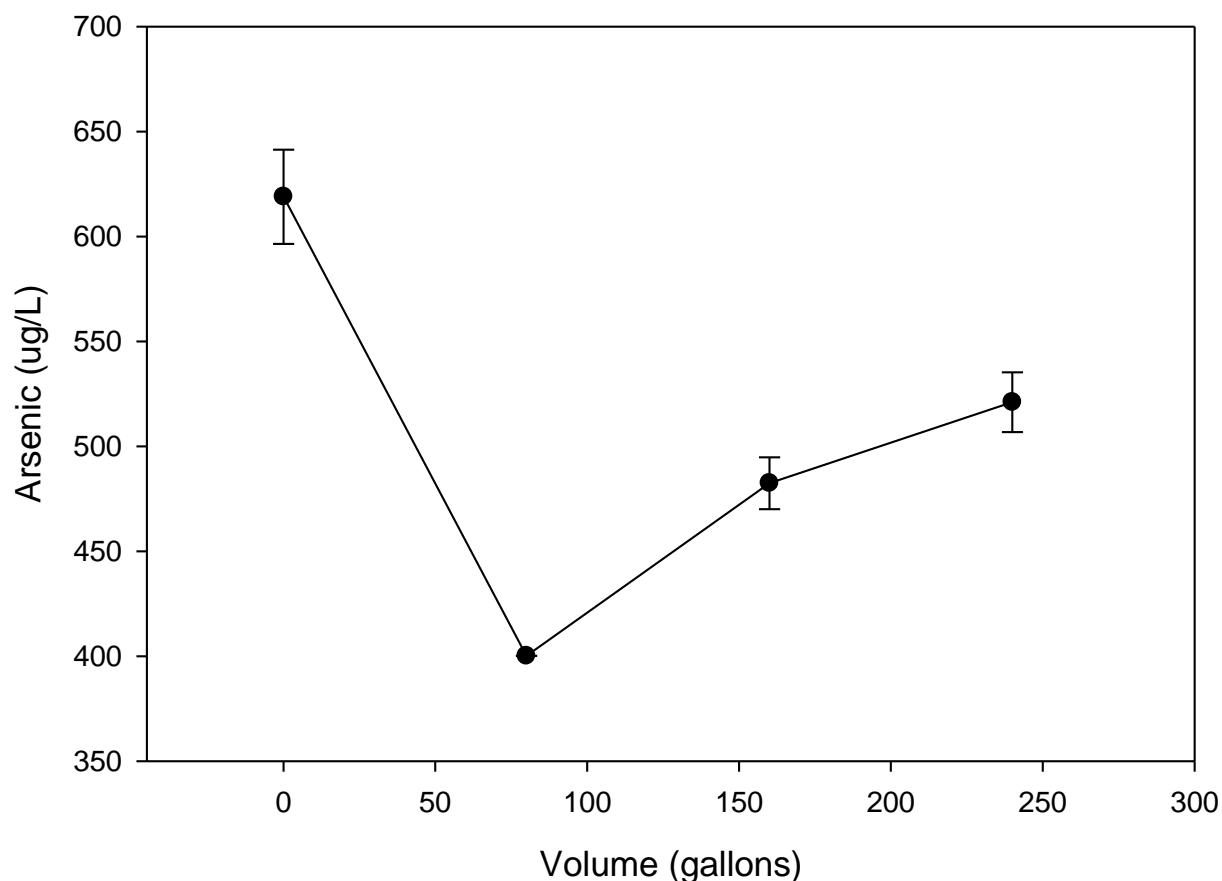
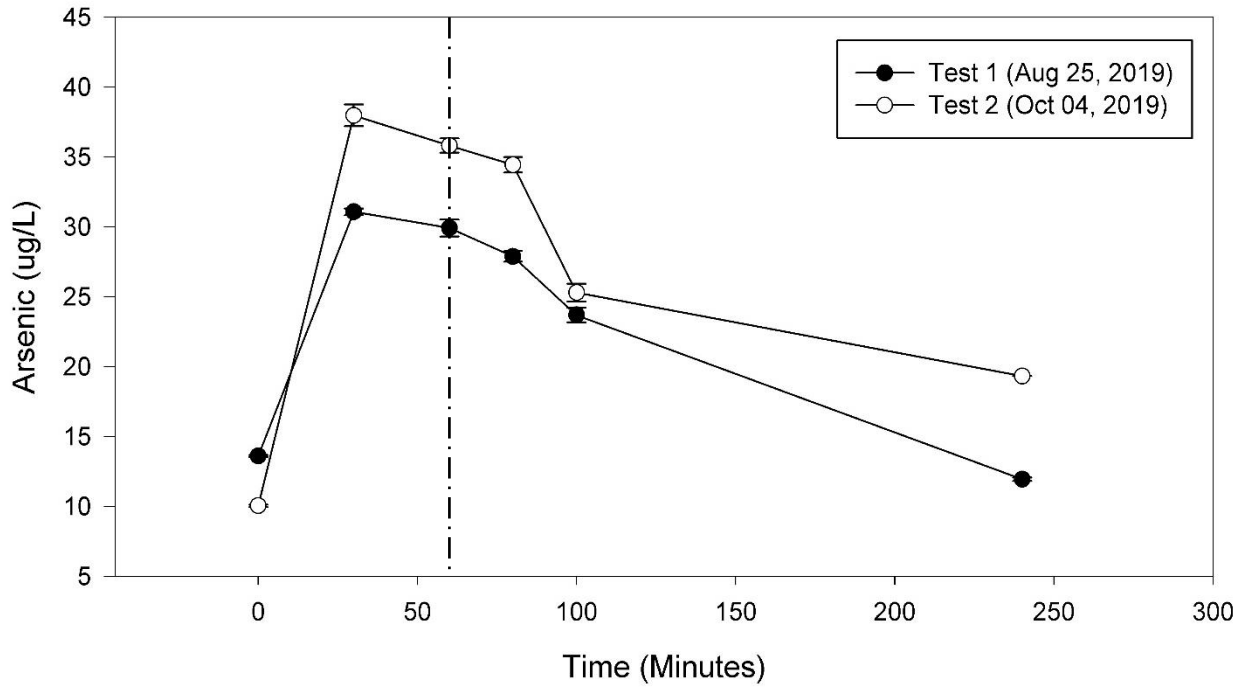

Figure 32. Pump test conducted at location L15. Comparing volume pumped (gallons) to total arsenic concentration (ug/L).

Tests were also conducted on wells L5 and L6 to determine how arsenic concentrations rebounded after pumping had ceased (Figure 33). Well L5 displayed decreasing arsenic concentrations after pumping ceased in both tests. Arsenic concentrations returned to initial values after 3 hours during the August test, and appeared to be more gradual in decline in October, decreasing 64% of the way back to initial concentration. Well L6 displayed decreasing arsenic concentrations in tests 1 and 3 where pumping ceased, however values did not return to initial concentrations. Arsenic values decreased 33 and 52% of the way back to initial concentrations, respectively. Test 2 displayed arsenic concentrations as a result of continuous

### 1-Hour Pump & Post-Pump Test (Overlay): L5



### 1-Hour Pump & Post-Pump Test (Overlay): L6

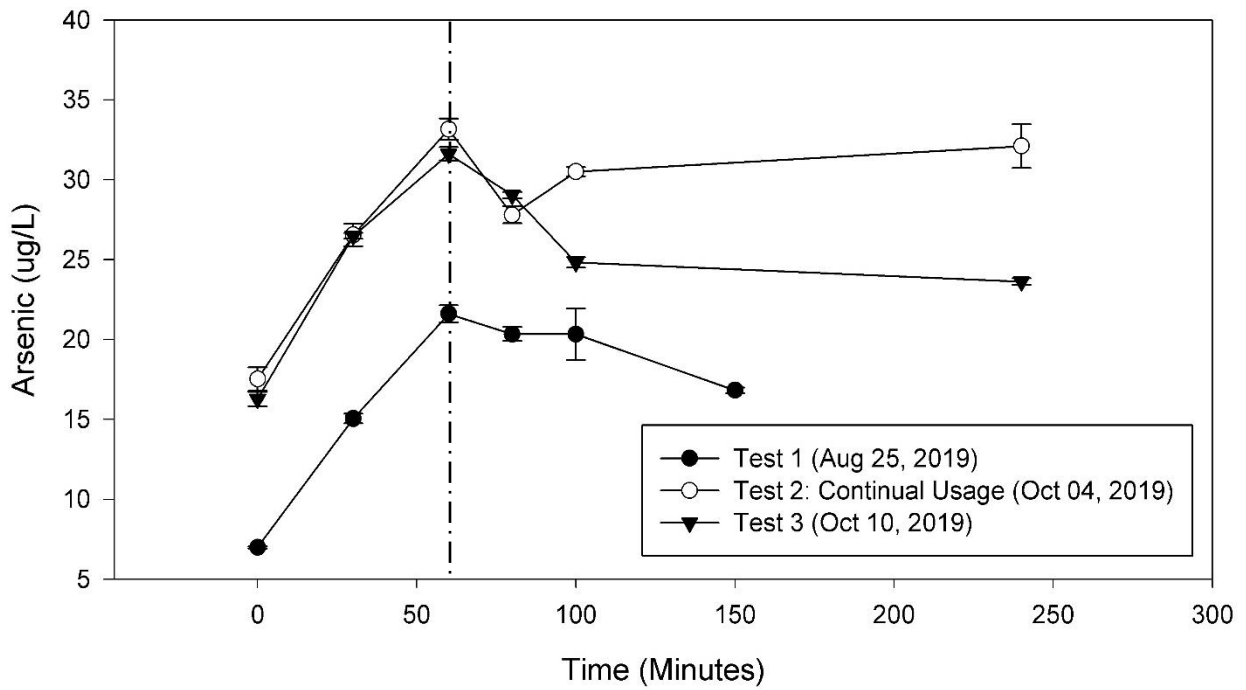

Figure 33. Arsenic concentrations following 1-hour pump tests. Location L5 (top) and Location L6 (bottom) show rebounding arsenic values. Vertical dash-dot line shows stoppage of pumping.

usage throughout the post-pump 3-hour period. The homeowner continued to use water for household activities such as laundry (~50 gallons), and arsenic concentrations failed to decrease.

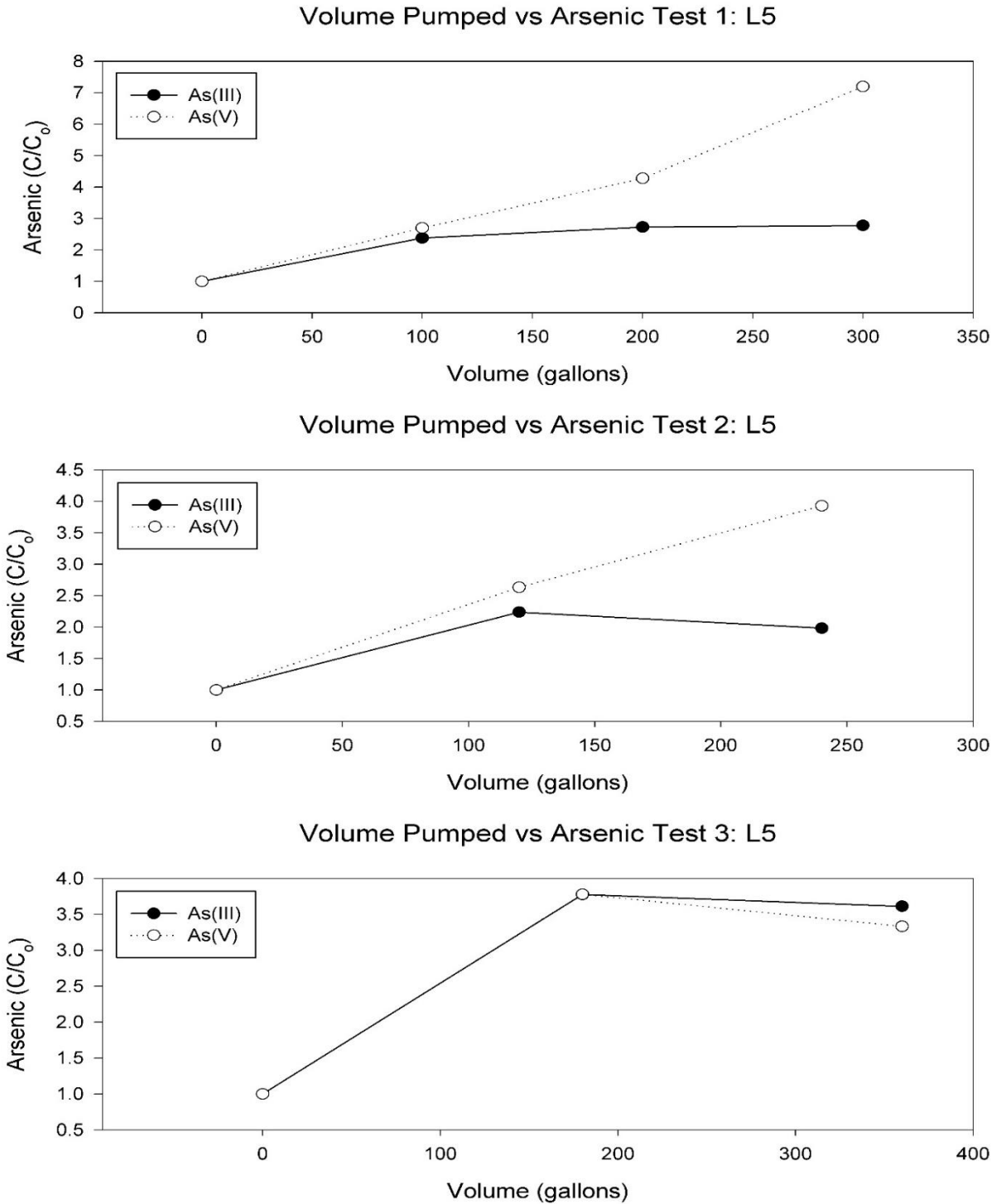
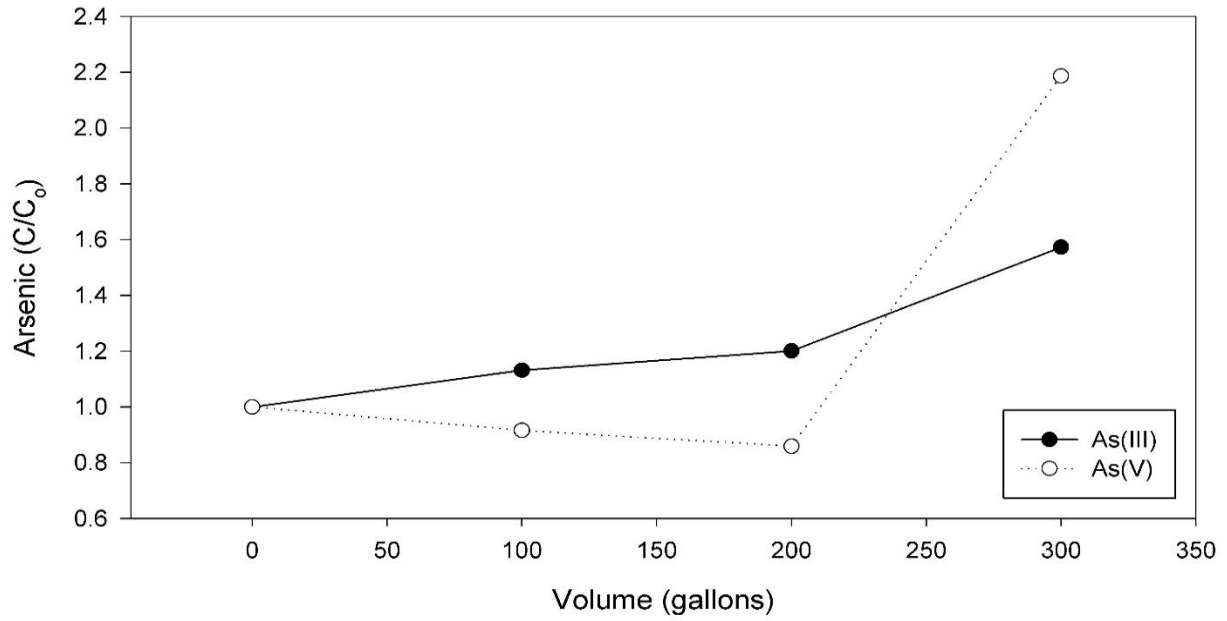

Figure 34. Location L5 arsenic species (C/Co) variation through pumping.

Volume Pumped vs Arsenic Test 1: L6



Volume Pumped vs Arsenic Test 2: L6

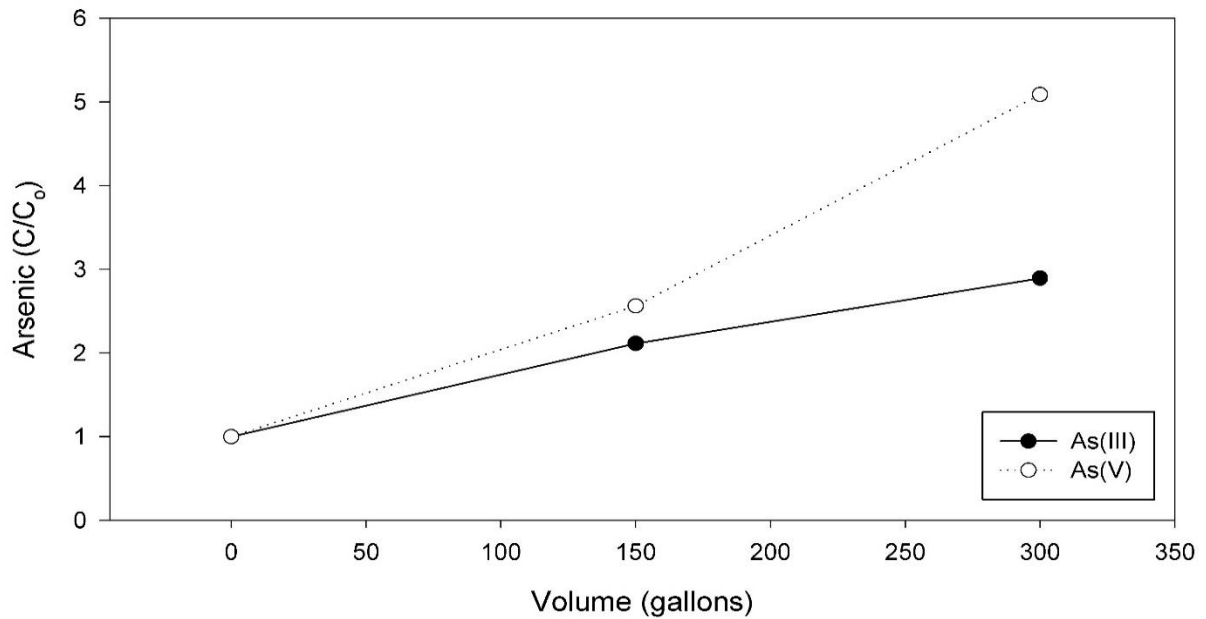
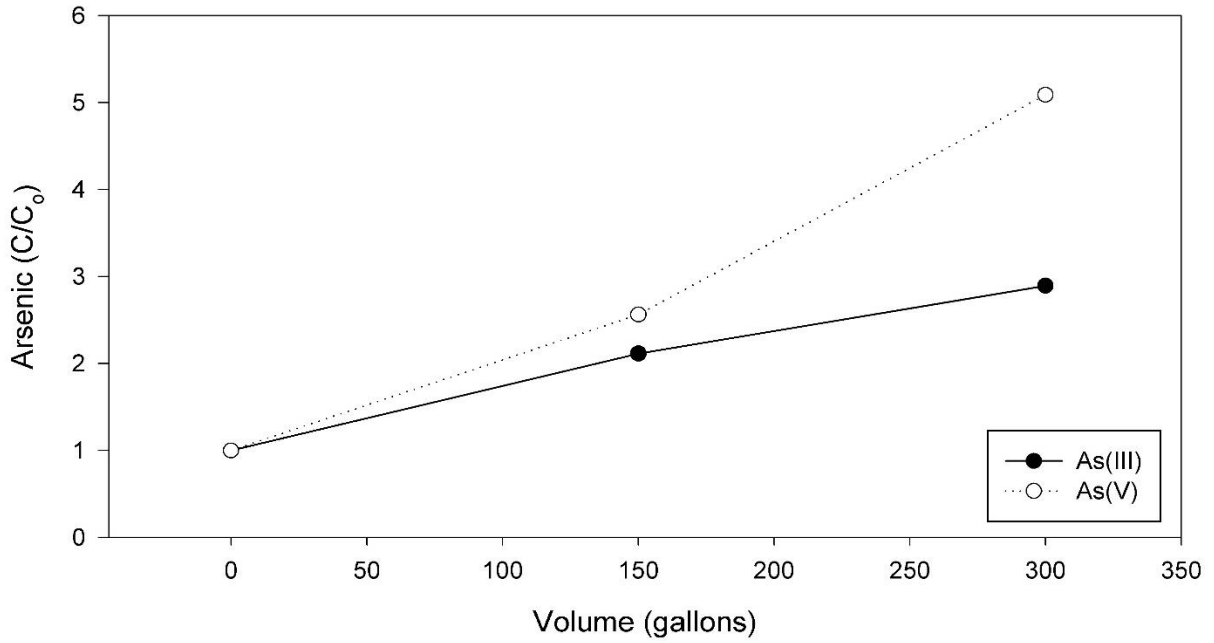

Figure 35. Location L6 arsenic species (C/C<sub>0</sub>) variation through pumping (tests 1-2).

Volume Pumped vs Arsenic Test 3: L6



Volume Pumped vs Arsenic Test 4: L6

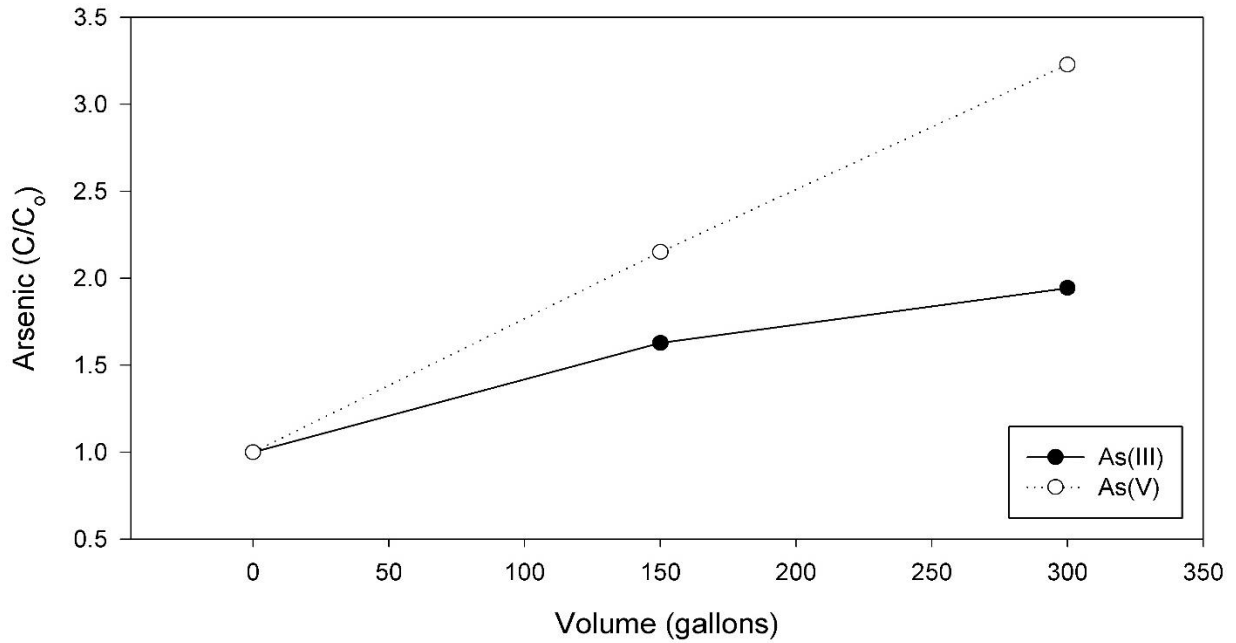

Figure 36. Location L6 arsenic species (C/C<sub>0</sub>) variation through pumping (tests 3-4).

### Volume Pumped vs Arsenic: L15

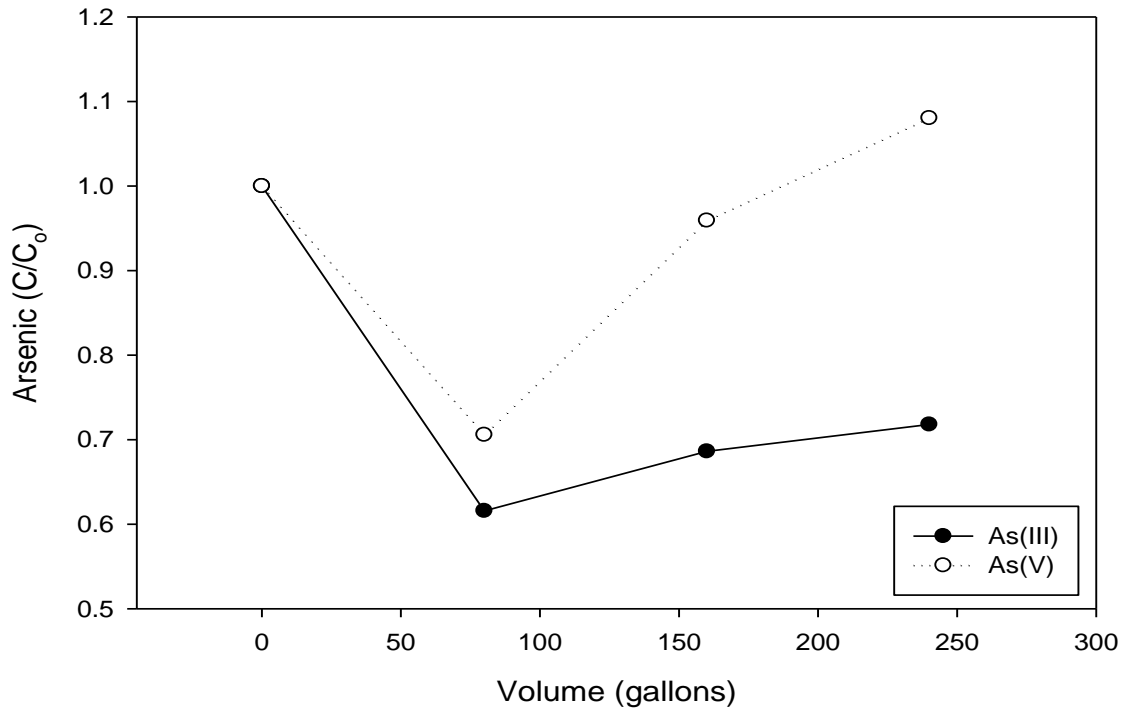

Figure 37. Location L15 arsenic species (C/C<sub>0</sub>) variation through pumping.

Pump tests were also utilized to demonstrate variations in arsenic species. Wells L5, L6, and L15 all exhibited increasing arsenic concentrations, thus the concentration of one or both of the arsenic species must increase as well. Although arsenic species was dominated at all locations by As(III), during the pump tests As(V) appeared to increase more substantially than As(III) (Figures 34-37). By the conclusion of the pump tests, many of the C/C<sub>0</sub> values for As(V) were 1.5 – 2 times greater than that of As(III). As(V) did not appear to deviate greatly from As(III) until after approximately 150 gallons of pumping. The increase in As(V) C/C<sub>0</sub> values can be attributed to oxidation from borehole during pumping. Redox sensitive ions such as SO<sub>4</sub><sup>2-</sup> and Fe<sup>3+</sup> did not show a substantial trend during pumping.

### 3.3 Group 2: Moderate Arsenic Increase

The second group of wells, L3, L9, and L18 all exhibited changes in arsenic concentration during pumping, however increases weren't as substantial ( $1 \text{ ug/L} < \text{As} < 15 \text{ ug/L}$ ). Based upon well construction reports, it was inferred that well L3 was drawing water from the Eastern Silurian dolomite, well L9 was drawing water from the Sinnipee dolomite, and well L18 was drawing water from at or near the SCH.

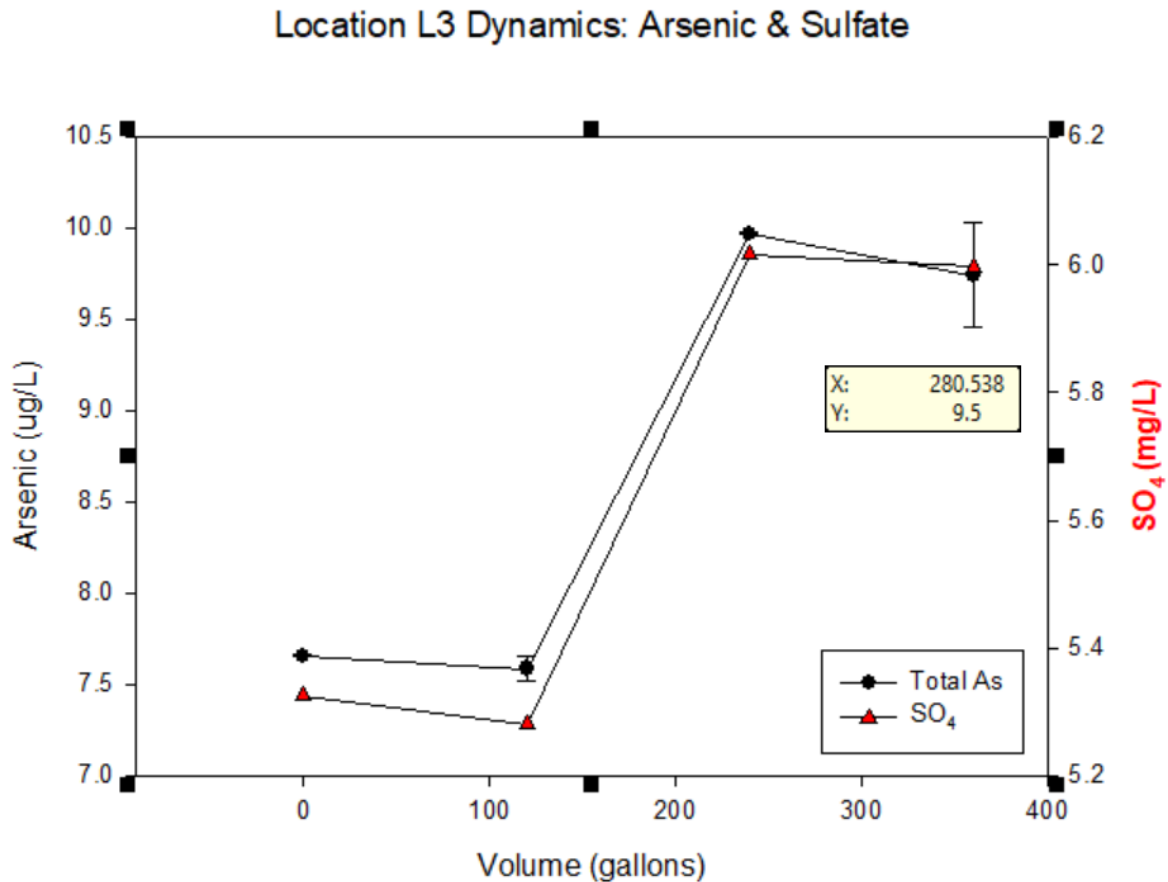

Figure 38. Pump test conducted at location L3. Comparing volume pumped (gallons) to total arsenic (left axis) and sulfate (right axis) concentration.

Well L3 did not show a trend in total arsenic concentration for the first 20 minutes of pumping, however a 2.31 ug/L increase occurred between 20 and 40 minutes (120 and 240 gallons) and a slight decrease in concentration for the last 20 minutes of the test. The arsenic

trend coincided directly with sulfate concentration, which is conducive of oxidizing conditions (Figure 38).

Well location L9 exhibited an increase of arsenic by 6.19 ug/L through the first 40 minutes (280 gallons) of pumping followed by a slight decrease for the remainder of the test (Figure 39). At the beginning of this pump test arsenic concentrations were already 4 times greater than the EPA MCL and became more dangerous as the test continued. There did not appear to be a trend with respect to the redox ions or water quality measures through pumping, rather most concentrations remained unchanged making it difficult to infer the reason for arsenic increase.

Location L9 Pump Test vs Arsenic

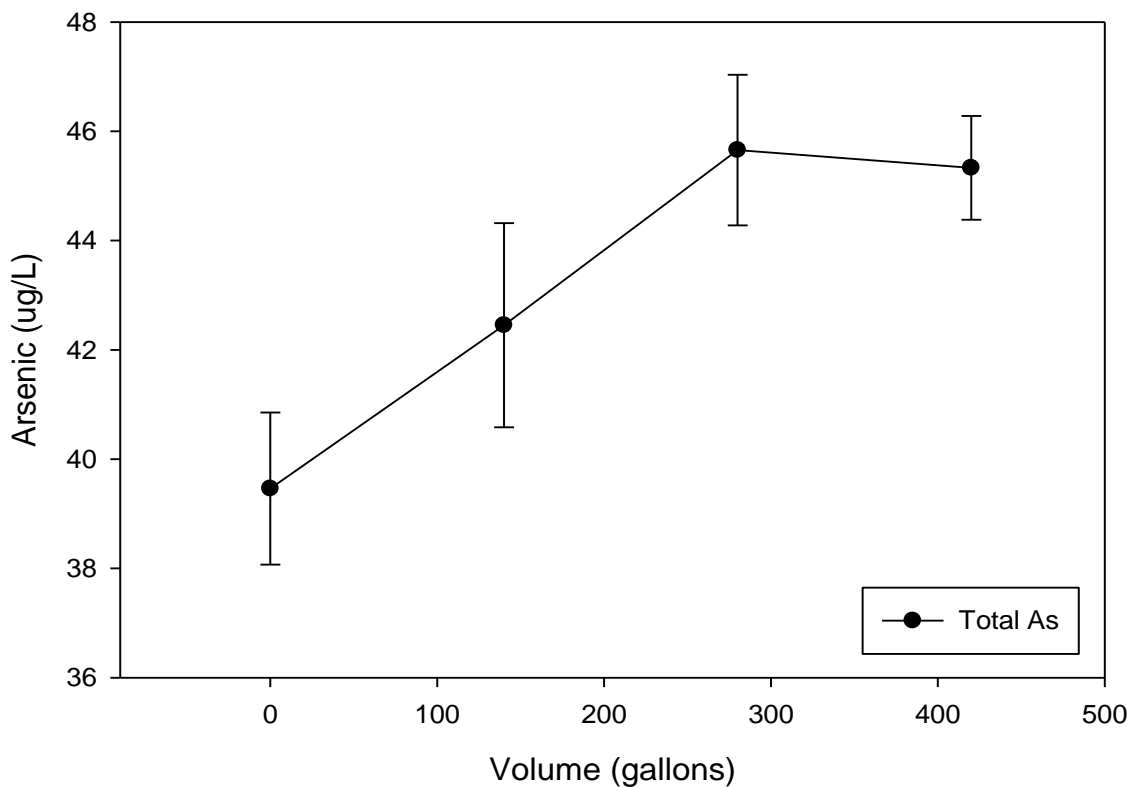

Figure 39. Pump test conducted at location L9. Comparing volume pumped (gallons) to total arsenic concentration (ug/L).

### Location L18 Pump Test vs Arsenic

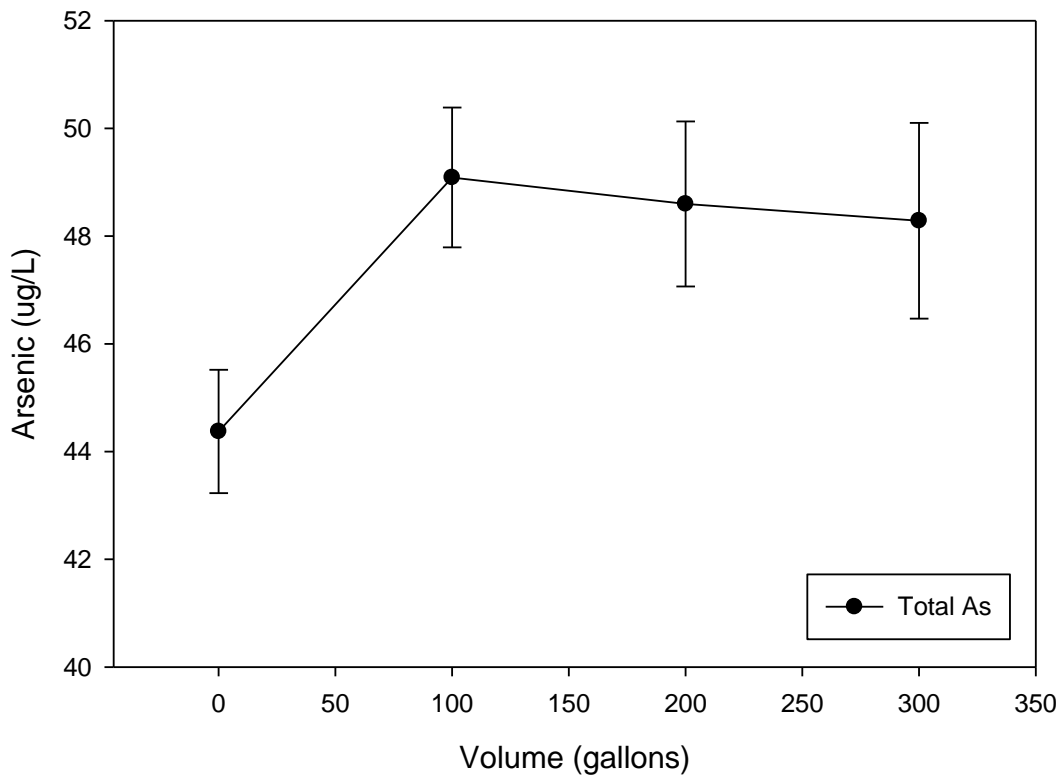
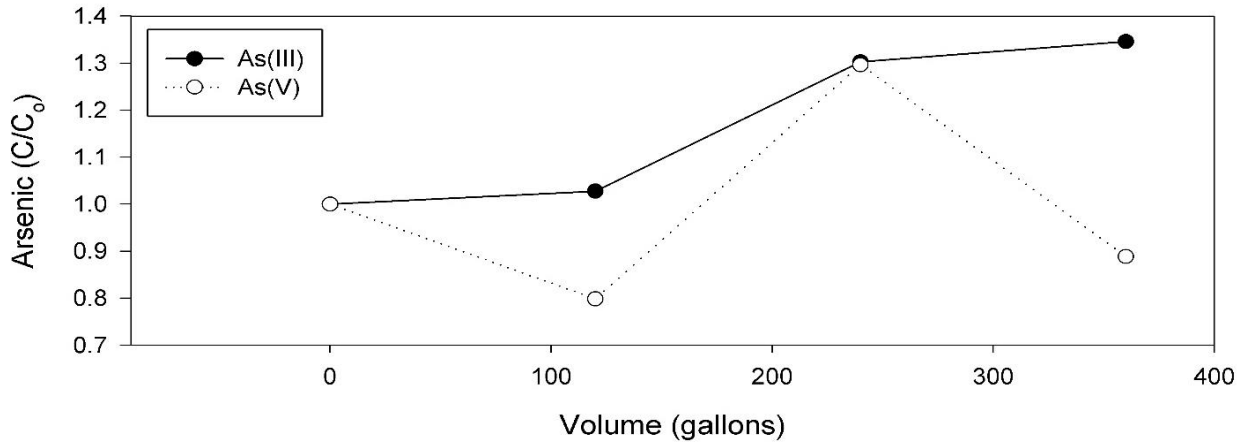

Figure 40. Pump test conducted at location L18. Comparing volume pumped (gallons) to total arsenic concentration (ug/L).

Well location L18 displayed an increase in total arsenic of 4.72 ug/L during the first 20 minutes (100 gallons) of pumping followed by a slight decrease for the remaining 40 minutes of the test (Figure 40). Like well L9, arsenic concentrations were over 4 times the EPA MCL at the beginning of the test and increased towards more dangerous levels as the test continued. Similar to the other wells in this group, it did not show many trends with respect to water quality measures or redox ions. All locations in this group appeared to reach a peak concentration at some point during the pump test and then decrease as the test continued.

Pump tests were also utilized to demonstrate variations in arsenic species at these three locations (Figure 41). Although As(III) was the dominant species in each well during each test,

Volume Pumped vs Arsenic: L3



Volume Pumped vs Arsenic: L9

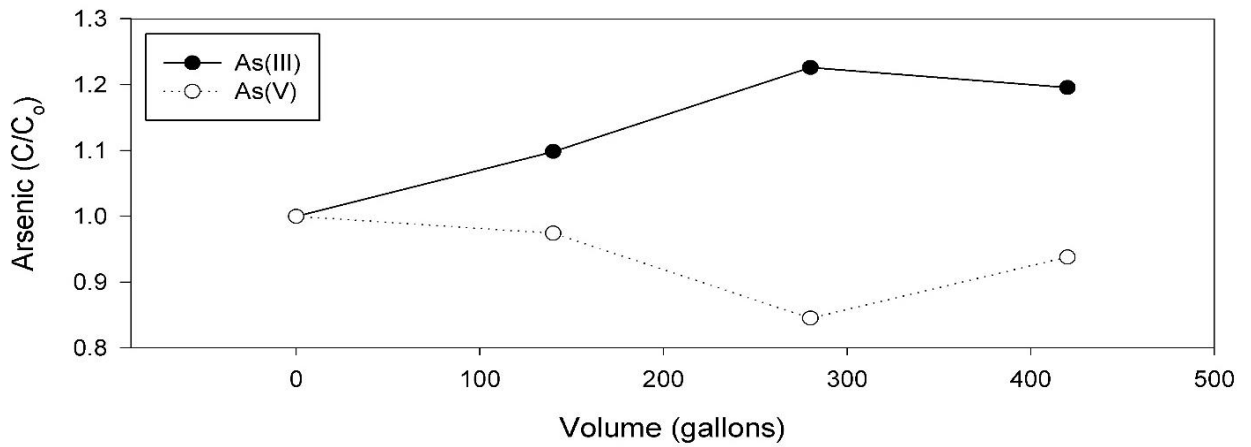

Volume Pumped vs Arsenic: L18

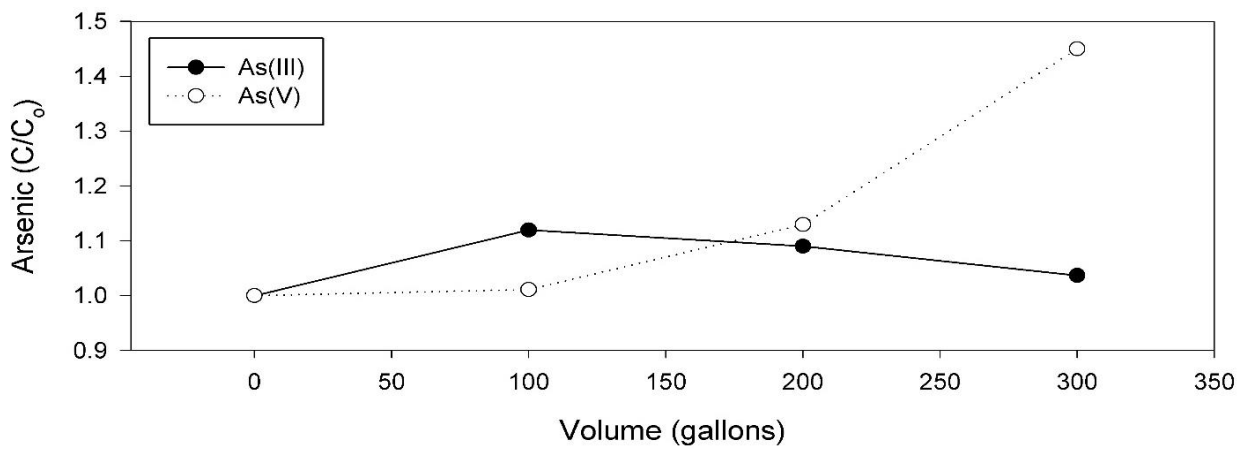

Figure 41. Locations L3 (top), L9 (middle), & L18 (bottom) arsenic species (C/C<sub>0</sub>) variation through pumping.

variations occurred throughout the pump tests. Arsenic  $C/C_o$  values for As(III) and As(V) were not consistent in this group of wells. Well L3 displayed a trend in which As(III)  $C/C_o$  values were dominant for the first 20 minutes, followed by As(V) for the second 20 minutes, and As(III) became dominant in the final 20 minutes. Based upon this trend, there appeared to be a relationship between As(III)  $C/C_o$  values and total As concentration. As As(III)  $C/C_o$  values became more significant, total arsenic concentrations appeared to increase and vice versa.

Well L9 displayed a trend in which As(III)  $C/C_o$  values increased while As(V) values decreased through the first 40 minutes of pumping, followed by As(III) values decreasing and As(V) values increasing for the remaining 20 minutes of pumping. Comparing this trend to that of total arsenic, total arsenic concentrations reflected As(III)  $C/C_o$  values, increasing as As(III)  $C/C_o$  increased and vice versa.

Well L18 displayed a trend in which As(III)  $C/C_o$  values increased more substantially than As(V) values for the first 20 minutes of pumping, followed by decreasing As(III) values and increasing As(V) values for the remaining 40 minutes of pumping. The increasing  $C/C_o$  trend of As(V) species is consistent with the first group of wells (Figures 33-36); however, when comparing total arsenic concentrations to As(V)  $C/C_o$  values, there appeared to be a trend more representative of the wells in this group (i.e. increasing As(III)  $C/C_o$  = increasing Total As).

### **3.4 Group 3: Unsubstantial Arsenic Increase**

The third group of wells, L1, L2, and L16 exhibited unsubstantial changes in arsenic concentration from the beginning of the pump test to the end ( $<1$  ug/L), however did exhibit small changes throughout the test. Based upon well construction reports, it was inferred that well

L1 was drawing water from the Sinnipee dolomite, well L2 was drawing water from the Eastern Silurian dolomite, and well L18 was drawing water from at or near the SCH.

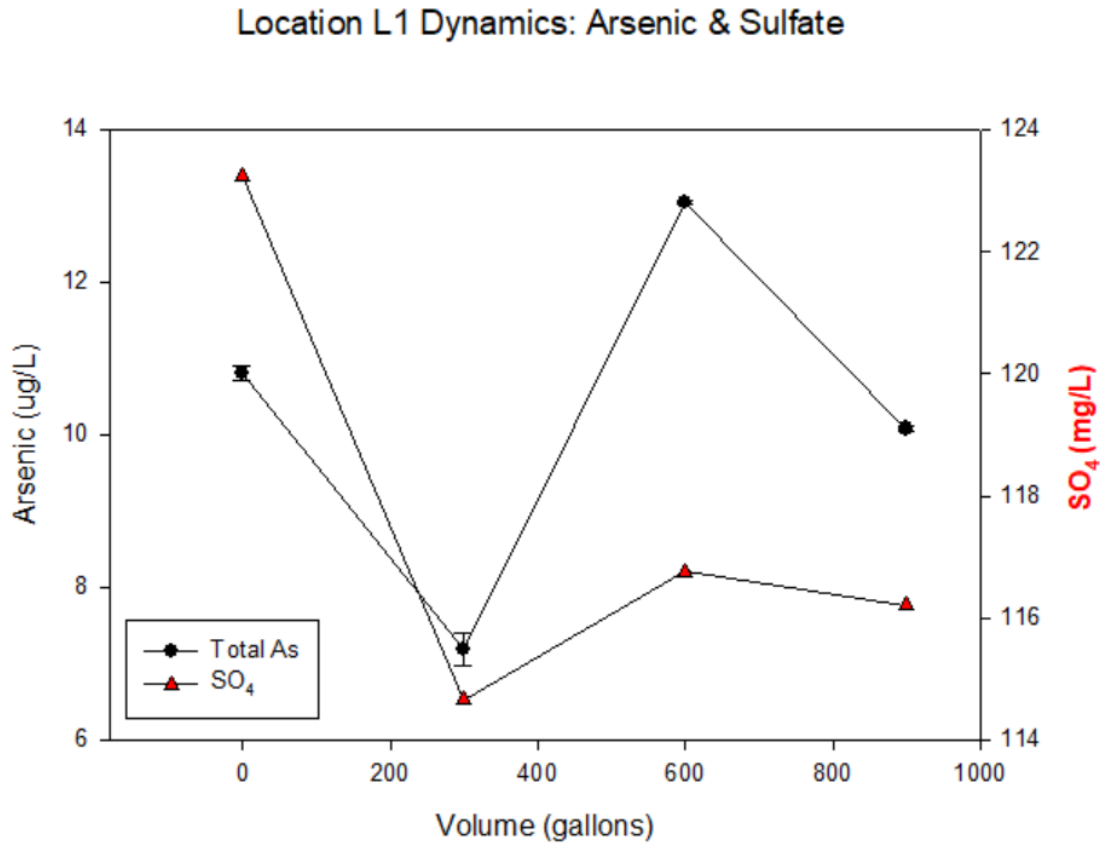
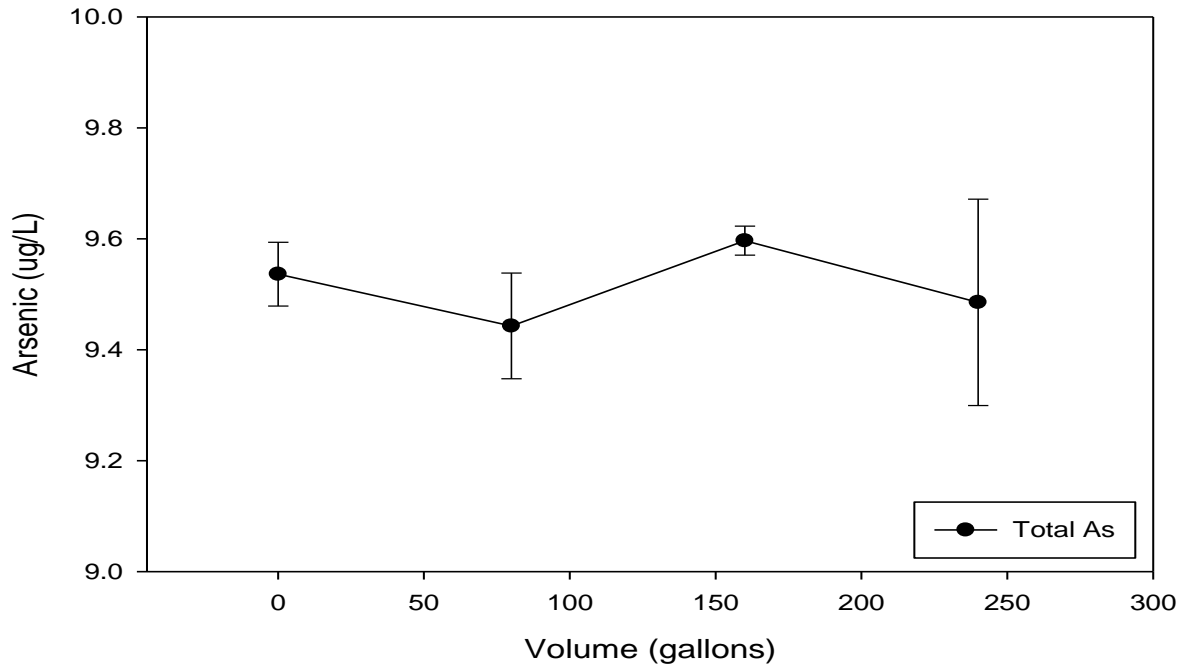

Figure 42. Pump test conducted at location L1. Comparing volume pumped (gallons) to total arsenic (left axis) and sulfate (right axis) concentration.

Well location L1 exhibited increasing and decreasing trends in total arsenic concentration throughout the 1-hour pump test. Through the first 20 minutes, total arsenic decreased by 3.63 ug/L, followed by an increase of 5.85 ug/L during the next 20 minutes, and a decrease of 2.96 ug/L during the final 20 minutes of pumping. The fluctuation in arsenic concentrations can be attributed to the well being pumped dry several times throughout the test due to elevated pumping rates. A direct relationship between sulfate and total arsenic was observed during the pump test, conducive of oxidation being responsible for arsenic release (Figure 42).

Location L2 Pump Test vs Arsenic



Location L16 Pump Test vs Arsenic

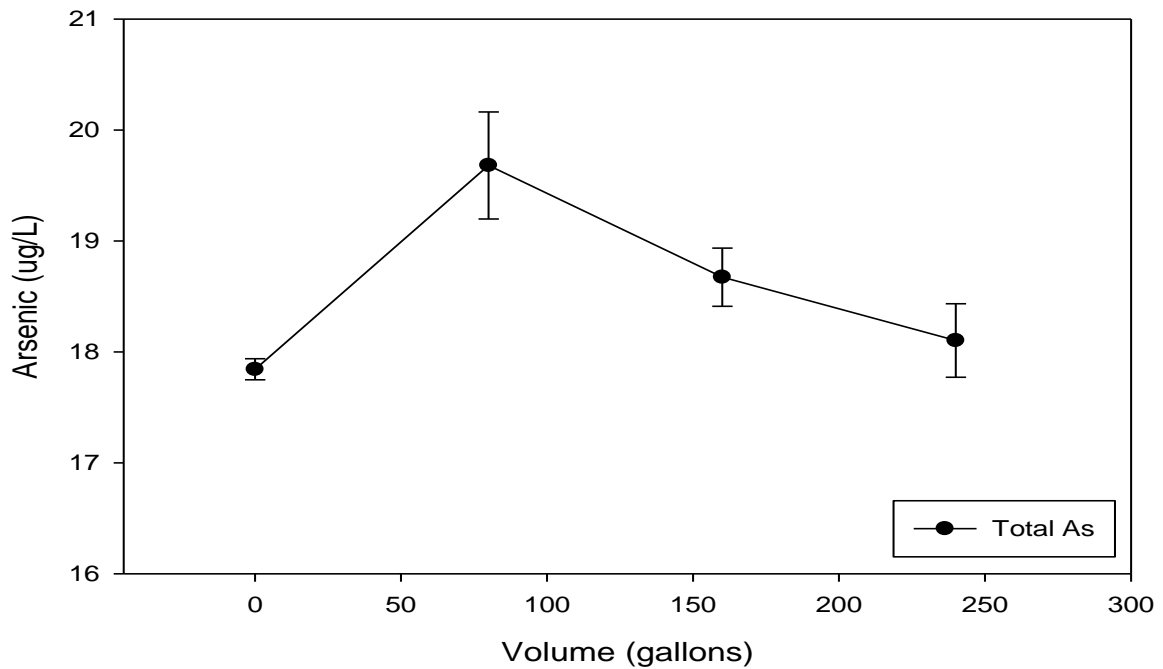

Figure 43. Pump tests conducted at location L2 (top) & L16 (bottom). Comparing volume pumped (gallons) to total arsenic concentration (ug/L).

Well Location L2 also exhibited increasing and decreasing trends in total arsenic concentrations throughout the pump test, however fluctuations were very minimal (<.20 ug/L). There did not appear to be any trends related to water quality measures or ion concentrations in the tests conducted at well L2.

Well location L16 displayed an initial increase in total arsenic of 1.84 ug/L during the first 20 minutes (80 gallons) of pumping. Following this initial increase, arsenic concentrations decreased for the following 40 minutes, approaching initial concentrations. Arsenic concentrations during this test were approximately twice that of the EPA MCL (19.68 ug/L). Higher arsenic concentrations were correlated with higher sulfate concentrations in Well L16.

Pump tests were also utilized to demonstrate variations in arsenic species at these three locations (Figure 43). Although As(III) was the dominant species in each well during each test, variations occurred throughout the pump tests. Well location L1 displayed a trend in which As(V) C/C<sub>o</sub> values decreased during the first 20 minutes of pumping to .31, increased for the next 20 minutes up to 2.57, and decreased during the last 20 minutes to .89. Total arsenic concentrations reflected this trend more so than As(III) C/C<sub>o</sub>.

Well location L2 did not display a trend with respect to As(V) C/C<sub>o</sub> values due to As(III) values being greater than total arsenic concentrations, thus all As(V) C/C<sub>o</sub> values were 1 (no change). Total arsenic concentrations appeared to be independent from As(III) C/C<sub>o</sub> values, as total arsenic concentration values did not change very much.

Volume Pumped vs Arsenic: L1

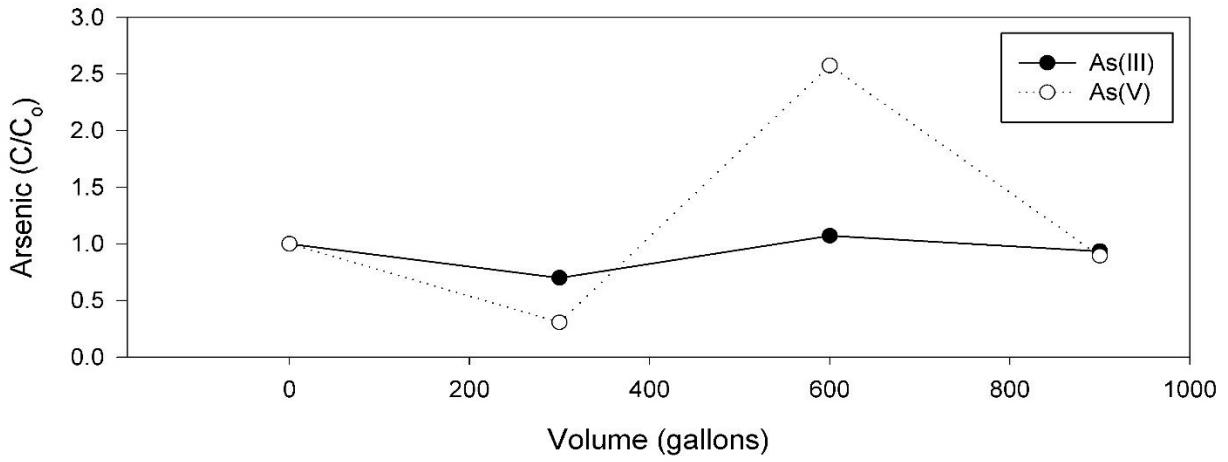

Volume Pumped vs Arsenic: L2

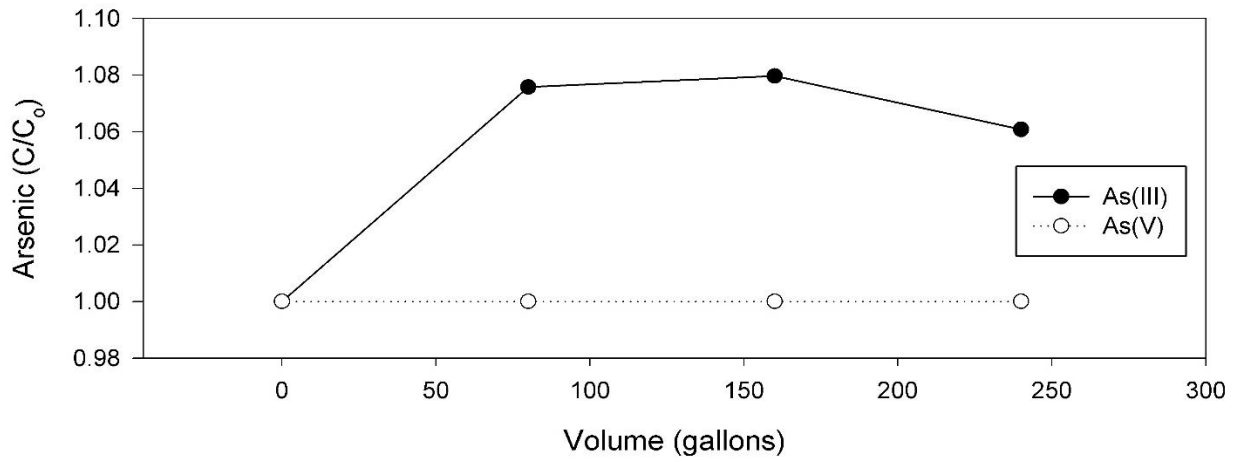

Volume Pumped vs Arsenic: L16

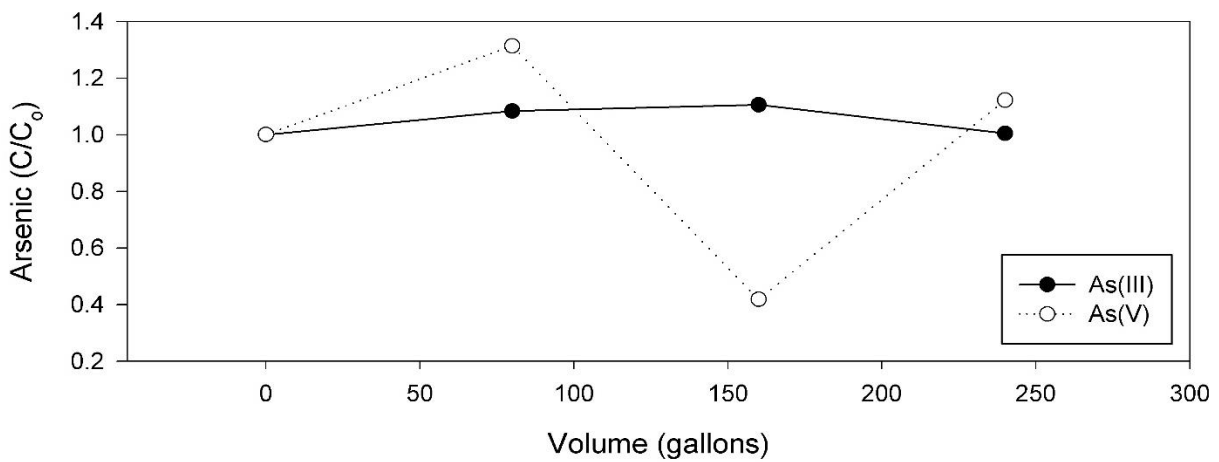

Figure 44. Locations L1 (top), L2 (middle), & L16 (bottom) arsenic species (C/C<sub>0</sub>) variation through pumping.

Well location L16 showed As(V)  $C/C_o$  values increasing for the first 20 minutes of pumping, followed by decreasing substantially for the next 20 minutes, and concluded by increasing for the final 20 minutes. As(III)  $C/C_o$  values did not change substantially throughout the pump test. The increase in total arsenic concentration could be explained by the spike in As(V) concentration during the first 20-minute interval and the decrease in arsenic concentration can be explained by the decrease in As(V) concentration during the next 20-minute interval. Comprehensively, total arsenic detected in the wells within this group did not have strong relationships with arsenic species, primarily due to low arsenic variation.

### **3.5 Comprehensive Geologic Interpretation of Arsenic Dynamics**

Group 1 wells, (L5, L6, L15) consisting of wells with the most substantial increases in arsenic concentrations ( $>15$  ug/L), are approximately screened at or near the location where the SCH is anticipated to be located, between the Sinipee dolomite and St. Peter Sandstone units. In the SCH there is a concentrated band of mineralization consisting of pyrite and marcasite (sulfide minerals). Previous research conducted in this region involving arsenic isotopic signatures found nearly identical  $\delta^{34}\text{S}$  values in the SCH and in the groundwater, suggesting that oxidation of these sulfide minerals is the dominant mechanism (Schreiber et al. 1999). Furthermore, As(V) is the dominant species that is released from oxidation reactions involving sulfide minerals (Shafer et al. 2005). Although there are many variables that are responsible for arsenic release, one of the most important variables is the location of the water level. If during pumping, water levels are drawn below the SCH exposing the pyrite and marcasite to air, oxidation of those minerals increases the concentration of arsenic in the water (Schreiber et al. 1999). Utilizing the variables responsible for arsenic release, it may be deduced that group 1 wells have substantial increases in arsenic concentration due to the presence of sulfide minerals coupled with a static water level

present near the SCH. The increase in As(V) species relative to As(III) in group 1 wells further explains the oxidation theory.

Other wells such as L16 and L18 appear to be screened at or near the SCH however do not exhibit significant changes in arsenic concentration during pump tests. Based upon well construction reports, water levels in these wells are much higher than the approximate level of the SCH, which doesn't favor oxidation via water level decrease as a mechanism for arsenic release. Rather, changes in arsenic concentration observed through pumping are more likely attributed to dissolved oxygen being introduced via disturbance of the borehole while pumping. It is important to note, although arsenic doesn't increase substantially in the aforementioned wells due to water table proximity, arsenic concentrations are still typically above the EPA MCL due to proximity to the SCH.

The moderate, or small to no change, that was displayed by the remaining wells in groups 2 and 3, can be explained by a combination of the aforementioned variables responsible for arsenic dynamics. Based upon the well construction reports it can be deduced that the wells are not near the SCH, however the wells are still screened in the dolomite. Sulfide minerals such as pyrite and marcasite are still present in the dolomite however, they are not present in a mineralized layer, rather nodules or veins that aren't as concentrated. Water levels may still fluctuate due to pumping, releasing arsenic into the groundwater, however not at as substantial of a rate.

## **Chapter 4: Conclusions**

This study examined the minute-scale pumping dynamics and speciation of naturally occurring arsenic in groundwater in the eastern Silurian dolomite and the Cambrian-Ordovician

sandstone and dolomite across eastern Wisconsin. This study investigated private drinking water wells to determine if water usage, via 1-hour pump tests, results in higher arsenic concentrations, as well as which species of arsenic dominates the groundwater and how the species concentrations change with pumping. A better understanding of these dynamics is critical for determining long-term exposure, health risks, and design and implementation of water treatment techniques.

This study concluded that arsenite (As(III)) was the dominant arsenic species present in the eastern Silurian dolomite and Cambrian-Ordovician sandstone and dolomite. During the winter, As(III) dominated the groundwater samples by an average of 76.8%, while in the summer, As(III) dominated by an average of 86.3%. Wells that contained arsenic had an average total arsenic of 86.8 ug/L in the winter, and an average total arsenic concentration of 72.9 ug/L in the summer. The highest arsenic concentration detected in this study was 764.83 ug/L, occurring in Winnebago county located in east central Wisconsin (Fox River valley).

Furthermore, total arsenic concentrations were primarily associated with the geologic unit in which each well is screened, coupled with the location of the water level in relation to the source minerals. Wells which exhibited substantial increases in arsenic concentration ( $>15$  ug/L) during 1-hour pump tests, were screened at or near the sulfide cement horizon with the water table in close proximity. Substantial arsenic increases were accompanied with increasing As(V) concentrations during pumping, indicative of sulfide mineral oxidation. Wells which exhibited moderate increases in arsenic concentration ( $1$  ug/L  $<$  As  $<$   $15$  ug/L) during 1-hour pump tests, were screened either at or near the sulfide cement horizon while the water table wasn't in close proximity; or they were screened in the Sinipee dolomite with the water table in close

proximity. Wells that didn't display an increase in arsenic concentration (<1 ug/L) during 1-hour pump tests, were also screened in various aquifers, however these exhibited stable water quality measures and ion concentrations, indicating that short-term pumping isn't responsible for arsenic presence in these wells.

Post-pump analysis conducted on wells demonstrating substantial arsenic increase showed that arsenic concentrations decrease towards initial values with time. During one post-pump test at well location L5, arsenic concentrations returned to initial values after a 3-hour period of non-use. Other post-pump analyses conducted at well location L5 and L6 showed arsenic concentrations not returning to initial values after 3 hours of non-use, however decreasing substantially. One test was conducted where water use continued inside the house throughout the 3-hour post-pump period and arsenic values remained substantial throughout.

Understanding which groundwater system drinking water is being extracted from is the first step in determining if arsenic may be present. Testing water regularly for arsenic is important, as arsenic concentrations tend to increase over time. It is also essential that homeowners are cautious while using substantial amounts of water, not to use any for drinking or cooking until at least a few hours after the strenuous use. Lastly, it is important that appropriate household filtration, based upon arsenic species and water quality, is in place to limit one's exposure to naturally occurring arsenic.

## References

Anderson, L.C., Bruland, K.W., 1991. *Biogeochemistry of arsenic in natural waters: the importance of methylated species*. Environ. Sci. Technol. 25 (3), 420-427.

- Bahr, Jean & Gotkowitz, Madeline. (2004). Arsenic Contamination in Southeast Wisconsin: Sources of Arsenic and Mechanisms of Arsenic Release.
- Benson, D. (2009, June 15). Test for arsenic, Ozaukee well owners told. Retrieved from <http://archive.jsonline.com/news/wisconsin/48085862.html/>
- Ellenhorn MJ. 1997. *Ellenhorn's Medical Toxicology: Diagnosis and Treatment of Human Poisoning*. 2nd ed. Baltimore: Williams & Wilkins, 1540.
- Environ Health Perspect. 2011 Oct; 119(10): 1356–1363. Published online 2011 Jun 17. doi: 10.1289/ehp.1103441
- Erickson, M., & Barnes, Randal J. (2005). *Arsenic in Upper Midwest Ground Water: Occurrence and Geochemical Mobilization Mechanisms*, ProQuest Dissertations and Theses.
- Gotkowitz, M. B.; Simo, J.A. (Juan Antonio); Schreiber, Madeline / *Geologic and geochemical controls on arsenic in groundwater in northeastern Wisconsin* [DNR-152] (2003)
- Gotkowitz, M., Schreiber, M., & Simo, J. (2004). Effects of Water Use on Arsenic Release to Well Water in a Confined Aquifer. *Ground Water*, 42(4), 568-575.
- Hach. (2014). *Iron, Total (Method 8008)* (9). Retrieved from <https://www.hach.com/wah>
- Hach. (2018). *Alkalinity (Method 8203)* (9). Retrieved from <https://www.hach.com/wah>
- Hach. (2018). *Sulfide (Method 8131)* (11). Retrieved from <https://www.hach.com/wah>
- Hach. (2019). *Iron, Ferrous (Method 8146)* (11). Retrieved from <https://www.hach.com/wah>
- Herath, I., Vithanage, M., Bundschuh, J. et al. *Curr Pollution Rep* (2016) 2: 68. <https://doi.org/10.1007/s40726-016-0028-2>
- Hughes, Michael. (2015). History of Arsenic as a Poison and a Medicinal Agent. 10.1002/9781118876992.ch1.
- J. Christopher States, Aaron Barchowsky, Iain L. Cartwright, John F. Reichard, Bernard W. Futscher, R. Clark Lantz
- Knobeloch, Lynda, Gorski, Patrick, Christenson, Megan, & Anderson, Hendry. (2013). Private drinking water quality in rural Wisconsin. *Journal of Environmental Health*, 75(7), 16-20.
- Larsen, O. and D. Postma. 2001. Kinetics of reductive bulk dissolution of lepidocrocite, ferrihydrite, and goethite. *Geochimica et Cosmochimica Acta* 9:1367-1379.
- Lu, P. & Zhu, C. *Environ Earth Sci* (2011) 62: 1673. <https://doi.org/10.1007/s12665-010-0652-x>
- Luczaj, J., & Masarik, K. (2015). Groundwater Quantity and Quality Issues in a Water-Rich Region: Examples from Wisconsin, USA. *Resources*, 4(2), 323-357.

- Luczaj, J.A. *Geology of the Niagara escarpment in Wisconsin*. Geosci. Wis. 2013, 22, 1–34. Available Online: <http://wgnhs.uwex.edu/pubs/gs22a01/> (accessed on 15 April 2015).
- Luczaj, John & McIntire, Michael & Hunt, Megan. (2016). Geochemical Characterization of Trace MVT Mineralization in Paleozoic Sedimentary Rocks of Northeastern Wisconsin, USA. *Geosciences*. 6. 29. 10.3390/geosciences6020029.
- Minnesota Department of Health. (2014). A Consumer's Guide to Water Wells in Minnesota. *WELL OWNER'S HANDBOOK, Fourth Edition*, 12.
- Mirza, B., Muruganandam, S., Meng, X., Sorensen, D., Dupont, R., McLean, J. (2014). Arsenic(V) Reduction in Relation to Iron(III) Transformation and Molecular Characterization of the Structural and Functional Microbial Community in Sediments of a Basin-Fill Aquifer in Northern Utah. *Applied and Environmental Microbiology*, 80(10), 3198-3208.
- Mok, W.M., Wai, C.M., 1990. Distribution and mobilization of arsenic and antimony species in the Coeur d'Alene River, Idaho. *Environ. Sci. Technol.* 24 (1), 102-108
- Najafpour, M., & Salimi, S. (2015). Carbon for engineering of a water-oxidizing catalyst. *Dalton Transactions*, 44(48), 20991-20998.
- Peggy A. O'Day, Dimitri Vlassopoulos, Robert Root, & Nelson Rivera. (2004). The influence of sulfur and iron on dissolved arsenic concentrations in the shallow subsurface under changing redox conditions. *Proceedings of the National Academy of Sciences of the United States of America*, 101(38), 13703-13708.
- Riewe, Tom & Weissbach, Annette & Heinen, Liz & Stoll, Rick. (2000). Naturally Occurring Arsenic In Well Water in Wisconsin. *Well Water Journal*. 54.
- Root, T. (2005). *Controls on arsenic concentrations in ground water from quaternary and silurian units in southeastern Wisconsin*.
- Root, T., Gotkowitz, M., Bahr, J., & Attig, J. (2010). Arsenic Geochemistry and Hydrostratigraphy in Midwestern U.S. Glacial Deposits. *Ground Water*, 48(6), 903-912.
- Schreiber, M., Simo, J., & Freiberg, P. (2000). Stratigraphic and geochemical controls on naturally occurring arsenic in groundwater, eastern Wisconsin, USA. *Hydrogeology Journal*, 8(2), 161-176.
- Schreiber, M.E. and others. 2003. Mechanisms of arsenic release to ground water from naturally occurring sources, eastern Wisconsin. In Welch, A.H. and Stollenwerk, K.G. Eds., *Arsenic in ground water, geochemistry and occurrence*. Kluwer Academic Publishers: Boston. 259-280.
- Shafer, M., Overdier, Joel T, & Kerr, Sara Christine. (2007). *Arsenic Species (III,V) Distribution In Wisconsin Groundwaters: Field Measurements and Prediction Using Multivariate Analysis of Geochemical Data* (Groundwater Research Report WR05R001). Madison: University of Wisconsin, Water Resources Institute.

- Smedley, P.L., Kinniburgh, D.G., 2002. A review of the source, behavior and distribution of arsenic in natural waters. *Appl. Geochem.* 17 (5), 517-568.
- Smith, A., Lingas, E., & Rahman, M. (2000). Contamination of drinking-water by arsenic in Bangladesh: A public health emergency. *Bulletin of the World Health Organization*, 78(9), 1093-1103.
- Smith, A., Lingas, E., & Rahman, M. (2000). Contamination of drinking-water by arsenic in Bangladesh: A public health emergency. *Bulletin of the World Health Organization*, 78(9), 1093-1103.
- Smith, Ah, Hopenhaynrich, C, Bates, Mn, Goeden, HM, Hertzpicciotto, I, Duggan, HM, . . . Smith, Mt. (1992). CANCER RISKS FROM ARSENIC IN DRINKING-WATER. *Environmental Health Perspectives*, 97, 259-267.
- Sorg, T., Chen, A., & Wang, L. (2014). Arsenic species in drinking water wells in the USA with high arsenic concentrations. *Water Research*, 48, 156-169.
- States, J. (2015). History of Arsenic as a Poison and a Medicinal Agent. In *Arsenic* (pp. 1-22). Hoboken, NJ: John Wiley & Sons.
- Thornburg, K., & Sahai, N. (2004). Arsenic Occurrence, Mobility, and Retardation in Sandstone and Dolomite Formations of the Fox River Valley, Eastern Wisconsin. *Environmental Science & Technology*, 38(19), 5087-5094.
- Trujillo, D., & Wang, Y. (2018). Separation of Arsenic Species (As(III) and As(V)) Using Ion Exchange Resin. Department of Civil and Environmental Engineering, University of Wisconsin-Milwaukee.
- United States Environmental Protection Agency. (2016, September). Quick Guide To Drinking Water Sample Collection. Retrieved November 1, 2019, from [https://www.epa.gov/sites/production/files/2015-11/documents/drinking\\_water\\_sample\\_collection.pdf](https://www.epa.gov/sites/production/files/2015-11/documents/drinking_water_sample_collection.pdf)
- United States Environmental Protection Agency. (1994). *Method 200.8, Revision 5.4: Determination of Trace Elements in Waters and Wastes by Inductively Coupled Plasma – Mass Spectrometry* (5). Retrieved from [https://www.epa.gov/sites/production/files/2015-08/documents/method\\_200-8\\_rev\\_5-4\\_1994.pdf](https://www.epa.gov/sites/production/files/2015-08/documents/method_200-8_rev_5-4_1994.pdf)
- United States Geological Survey . (2017, October 18). Study Estimates about 2.1 Million People using Wells High in Arsenic. Retrieved November 1, 2019, from <https://www.usgs.gov/news/study-estimates-about-21-million-people-using-wells-high-arsenic>
- USEPA, 2001. *National Primary Drinking Water Regulations: Arsenic and Clarifications to Compliance and New Source Contaminants Monitoring*. Federal Register 40 CFR Parts 9, 141, and 142.

- Wang, L., & Giammar, D. (2015). Effects of pH, dissolved oxygen, and aqueous ferrous iron on the adsorption of arsenic to lepidocrocite. *Journal of Colloid And Interface Science*, 448, 331-338.
- Welch, A.H., Lico, M.S., Hughes, J.L., 1988. Arsenic in ground water of the Western United States. *Ground Water* 26 (3), 333-347.
- Welch, A.H., Westjohn, D.B., Heisel, D.R., Wanty, R.B., 2000. Arsenic in ground water of the United States: occurrence and geochemistry. *Ground Water* 38 (4), 589-604
- Wilkie, J., & Hering, J. (1998). Rapid oxidation of geothermal arsenic(III) in streamwaters of the Eastern Sierra Nevada. *Environmental Science & Technology*, 32(5), 657-662.
- Wisconsin Department of Natural Resources. (2019). *Arsenic and Other Naturally-Occurring Elements*. Retrieved from <https://dnr.wi.gov/topic/Groundwater/documents/GCC/gwQuality/Arsenic.pdf>
- Wisconsin Geological & Natural History Survey. (n.d.). Wisconsin aquifers. Retrieved November 1, 2019, from <http://wgnhs.uwex.edu/water-environment/wisconsin-aquifers/>

## **APPENDICES**

## **APPENDIX A:**

### **Data Tables**

## Location L1

Sample Round	Date Sampled	As (ug/L)	As 3 (ug/l)	As 5 (ug/L)
1	12/20/2018	9.27	6.57	2.70
2	5/31/2019	10.82	9.86	0.96

Sample Round	pH	Cond. (us/cm)	Temp. (°C)	TDS (ppm)	ORP (mV)
1	7	917	16	455	n.a.
2	7.68	682	12	n.a.	-31

Sample Round	Ca (mg/L)	Mg (mg/L)	K (mg/L)	Na (mg/L)	Cl (mg/L)	NO3 (mg/L)	PO4 (mg/L)	SO4 (mg/L)
1	59.51	32.23	1.58	41.33	54.65	n.d.	n.d.	170.51
2	59.81	58.05	2.88	39.54	39.34	n.d.	0.23	123.25

Sample Interval	Rate (gpm)	Gallons Pumped	As (ug/L)	As 3 (ug/l)	As 3 %	As 5 (ug/L)	As 5 %
Initial	15	0	10.82	9.86	91.12	0.96	8.88
20 min	15	300	7.19	6.90	95.91	0.29	4.09
40 min	15	600	13.05	10.57	81.03	2.47	18.97
60 min	15	900	10.08	9.23	91.49	0.86	8.51

Sample Interval	Ferrous Fe (mg/L)	Ferric Fe (mg/L)	Total Fe (mg/L)
Initial	0.49	0.10	0.59
20 min	0.89	1.29	2.18
40 min	1.00	0.12	1.12
60 min	0.97	0.03	1.00

Sample Interval	Ca (mg/L)	Mg (mg/L)	K (mg/L)	Na (mg/L)	Cl (mg/L)	NO3 (mg/L)	PO4 (mg/L)	SO4 (mg/L)
Initial	59.81	58.05	2.88	39.54	39.34	n.d.	0.23	123.25
20 min	49.93	53.80	3.07	38.14	37.39	n.d.	n.d.	114.65
40 min	56.35	52.43	3.78	38.52	37.11	0.13	n.d.	116.75
60 min	56.90	52.52	2.90	38.71	37.02	n.d.	n.d.	116.21

## Location L2

Sample Round	Date Sampled	As (ug/L)	As 3 (ug/l)	As 5 (ug/L)
1	1/10/2019	9.00	6.85	2.15
2	6/22/2019	9.54	11.29	0.00

Sample Round	pH	Cond. (us/cm)	Temp. (°C)	TDS (ppm)	ORP (mV)
1	7.00	787.00	12.00	397.00	n.a.
2	7.43	1168.00	12.00	n.a.	-75.00

Sample Round	Ca (mg/L)	Mg (mg/L)	K (mg/L)	Na (mg/L)	Cl (mg/L)	NO3 (mg/L)	PO4 (mg/L)	SO4 (mg/L)
2	77.36	47.24	0.76	0.58	19.70	n.d	n.d.	45.51

Sample Interval	Rate (gpm)	Gallons Pumped	As (ug/L)	As 3 (ug/l)	As 3 %	As 5 (ug/L)	As 5 %
Initial	4	0	9.54	11.29	118.44	0.00	0.00
20 min	4	80	9.44	12.15	128.67	0.00	0.00
40 min	4	160	9.60	12.19	127.07	0.00	0.00
60 min	4	240	9.49	11.98	126.31	0.00	0.00

Sample Interval	Ferrous Fe (mg/L)	Ferric Fe (mg/L)	Total Fe (mg/L)
Initial	1.12	0.08	1.2
20 min	1.23	0.01	1.24
40 min	1.22	0.2	1.42
60 min	1.23	0	1.23

Sample Interval	Ca (mg/L)	Mg (mg/L)	K (mg/L)	Na (mg/L)	Cl (mg/L)	NO <sub>3</sub> (mg/L)	PO <sub>4</sub> (mg/L)	SO <sub>4</sub> (mg/L)
Initial	77.36	47.24	0.76	0.58	19.70	n.d	n.d.	45.51
20 min	79.46	45.50	0.77	0.57	24.34	n.d	n.d.	53.90
40 min	80.06	46.08	0.88	0.53	24.18	n.d	n.d.	53.62
60 min	84.56	48.89	1.30	0.51	24.46	n.d	n.d.	53.94

### Location L3

Sample Round	Date Sampled	Arsenic (ug/L)	As 3 (ug/l)	As 5 (ug/L)
1	1/17/2019	6.80	5.23	1.57
2	6/7/2019	7.66	6.42	1.24

Sample Round	pH	Cond. (us/cm)	Temp. (°C)	TDS (ppm)	ORP (mV)
1	7	500	11.4	254	n.a.
2	7.73	400	12.6	n.a.	-65.3

Sample Round	Ca (mg/L)	Mg (mg/L)	K (mg/L)	Na (mg/L)	Cl (mg/L)	NO3 (mg/L)	PO4 (mg/L)	SO4 (mg/L)
2	50.69	34.67	2.04	3.08	0.87	n.d.	n.d.	5.33

Sample Interval	Rate (gpm)	Gallons Pumped	As (ug/L)	As 3 (ug/l)	As 3 %	As 5 (ug/L)	As 5 %
Initial	6	0	7.66	6.42	83.82	1.24	16.18
20 min	6	120	7.59	6.60	86.96	0.99	13.04
40 min	6	240	9.97	8.37	83.88	1.61	16.12
60 min	6	360	9.74	8.64	88.69	1.10	11.31

Sample Interval	Ferrous Fe (mg/L)	Ferric Fe (mg/L)	Total Fe (mg/L)
Initial	1.75	0.34	2.09
20 min	1.93	0.2	2.13
40 min	0.57	0.05	0.62
60 min	0.45	0.01	0.46

Sample Interval	Ca (mg/L)	Mg (mg/L)	K (mg/L)	Na (mg/L)	Cl (mg/L)	NO3 (mg/L)	PO4 (mg/L)	SO4 (mg/L)
Initial	50.69	34.67	2.04	3.08	0.87	n.d.	n.d.	5.33
20 min	50.90	33.96	2.02	2.87	0.84	n.d.	n.d.	5.28
40 min	50.29	34.77	1.81	3.09	0.86	n.d.	n.d.	6.02
60 min	48.77	33.42	1.81	2.99	3.51	n.d.	0.76	6.00

## Location L4

Sample	Date Sampled	Arsenic			As 5	
		(ug/L)	As 3 (ug/l)	As 3 %	(ug/L)	As 5 %
Well	1/19/2019	2.96	2.03	68.59	0.93	31.41
RO Filter	1/19/2019	0.04	0.10	n.d.	n.d.	n.d.

Sample	Date Sampled	pH	Cond.	Temp.	TDS
			(us/cm)	(°C)	(ppm)
Well	1/19/2019	7	794	12.3	398

## Location L5

Sample	Date Sampled	Arsenic (ug/L)	STDDEV	As 3 (ug/l)	As 3 %	As 5 %
Initial	2/9/2019	14.25	0.51	10.48	73.51	26.49
Initial (Tap)	2/9/2019	17.36	3.40	3.72	21.41	78.59

Sample	Ca (mg/L)	Mg (mg/L)	K (mg/L)	Na (mg/L)	Cl (mg/L)	NO <sub>3</sub> (mg/L)	PO <sub>4</sub> (mg/L)	SO <sub>4</sub> (mg/L)
Initial	71.66	36.87	0.69	8.71	8.19	0.31	n.d.	16.59

Sample	pH	Cond. (us/cm)	Temp. (°C)	TDS (ppm)	Alkalinity (mg/L)
Initial	6.5	625	13.3	311	344

Sample (June 15)	Rate (gpm)	Gallons Pumped	As (ug/L)	As 3 (ug/l)	As 3 %	As 5 (ug/L)	As 5 %
Initial	5	0	10.59	12.84	100.00	0.00	0.00
20 min	5	100	31.05	30.51	98.26	0.54	1.74
40 min	5	200	35.86	35.01	97.62	0.85	2.38
60 min	5	300	37.04	35.60	96.12	1.44	3.88

Sample (June 15)	Ferrous Fe (mg/L)	Ferric Fe (mg/L)	Total Fe (mg/L)
Initial	0.59	0.58	1.17
20 min	0.82	0.09	0.91
40 min	0.77	0.3	1.07
60 min	0.77	0.22	0.99

Sample	Ca (mg/L)	Mg (mg/L)	K (mg/L)	Na (mg/L)	Cl (mg/L)	NO <sub>3</sub> (mg/L)	PO <sub>4</sub> (mg/L)
Initial	69.76	38.01	1.90	0.43	4.54	0.25	n.d.
20 min	69.36	38.22	1.80	0.41	4.10	0.40	n.d.
40 min	68.19	38.27	1.89	0.37	3.59	0.51	n.d.
60 min	69.30	38.13	1.09	0.35	3.06	0.29	n.d.

pH	Cond. (us/cm)	Temp. (°C)	ORP (mV)	eh
7.23	1083	15.4	142.2	0.34
7.23	986	11.8	33	0.23
7.24	983	11.6	-24.1	0.18
7.23	982	11.4	-23.5	0.18

<b>Sample Interval (Aug 25)</b>	<b>Rate (gpm)</b>	<b>Gallons Pumped</b>	<b>As (ug/L)</b>	<b>As 3 (ug/l)</b>	<b>As 3 %</b>	<b>As 5 (ug/L)</b>	<b>As 5 %</b>
Initial	6	0	13.62	12.11	88.91	1.51	11.09
30 min	6	180	31.08	27.10	87.20	3.98	12.80
60 min	6	360	29.92	23.99	80.16	5.94	19.84
20 min (post)	6	n.a.	27.89	24.34	87.28	3.55	12.72
40 min (post)	6	n.a.	23.70	20.49	86.46	3.21	13.54
180 min (post)	6	n.a.	11.96	10.75	89.92	1.21	10.08

<b>Sample Round 3 (Ions)</b>	<b>Date Sampled</b>	<b>Time (min)</b>	<b>Ferrous Fe (mg/L)</b>	<b>Ferric Fe (mg/L)</b>	<b>Total Fe (mg/L)</b>
Initial Test	8/25/2019	0	1.08	0.12	1.2
Purge 1 (30 min)	8/25/2019	30	0.96	0.12	1.08
Purge 2 (60 min)	8/25/2019	60	1.04	0.46	1.5
Stop (20 min)	8/25/2019	80	0.87	0.5	1.37
Stop (40 min)	8/25/2019	100	0.99	0.43	1.42
Stop (180 min)	8/25/2019	240	0.06	1.13	1.19

<b>Sample Round 3 (Ions)</b>	<b>Ca (mg/L)</b>	<b>Mg (mg/L)</b>	<b>K (mg/L)</b>	<b>Na (mg/L)</b>	<b>Cl (mg/L)</b>	<b>NO<sub>3</sub> (mg/L)</b>	<b>PO<sub>4</sub> (mg/L)</b>	<b>SO<sub>4</sub> (mg/L)</b>
Initial Test	71.35	37.85	2.33	n.d.	7.25	n.d.	n.d.	12.85
Purge 1 (30 min)	70.46	37.90	2.40	n.d.	5.84	0.12	n.d.	12.00
Purge 2 (60 min)	70.37	37.83	2.42	n.d.	5.64	0.17	n.d.	11.96
Stop (20 min)	69.49	37.44	2.28	n.d.	6.69	0.26	n.d.	12.02
Stop (40 min)	68.04	36.80	2.25	n.d.	5.81	0.12	n.d.	12.01
Stop (180 min)	71.24	37.77	2.26	n.d.	5.95	n.d.	n.d.	12.25

<b>Sample Round 3 (Ions)</b>	<b>pH</b>	<b>Cond. (us/cm)</b>	<b>Temp. (°C)</b>	<b>ORP (mV)</b>	<b>eh</b>
Initial Test	7.56	985	12	-56	0.14
Purge 1 (30 min)	7.6	977	11.6	-55.1	0.14
Purge 2 (60 min)	7.59	647	11.6	-51.7	0.15
Stop (20 min)	7.62	1024	13.4	-50.1	0.15
Stop (40 min)	7.65	931	15.1	-47.6	0.15
Stop (180 min)	7.62	1168	18.7	-29.2	0.17

Sample Interval (Oct 04)	Rate (gpm)	Gallons Pumped	As (ug/L)	As 3 (ug/l)	As 3 %	As 5 (ug/L)	As 5 %
Initial	6	0	10.06	8.27	82.21	1.79	17.79
30 min	6	180	37.98	31.22	82.20	6.76	17.80
60 min	6	360	35.82	29.86	83.36	5.96	16.64
20 min (post)	6	n.a.	34.45	29.19	84.72	5.26	15.28
40 min (post)	6	n.a.	25.31	22.01	86.99	3.29	13.01
180 min (post)	6	n.a.	19.32	15.51	80.25	3.82	19.75

Sample Interval (Oct 04)	Ferrous Fe (mg/L)	Ferric Fe (mg/L)	Total Fe (mg/L)
Initial	1.45	0	1.45
30 min	1.25	0	1.25
60 min	1.1	0	1.1
20 min (post)	1.17	0	1.17
40 min (post)	1.09	0.24	1.33
180 min (post)	1.05	0.26	1.31

Sample Interval (Oct 04)	Ca (mg/L)	Mg (mg/L)	K (mg/L)	Na (mg/L)	Cl (mg/L)	NO <sub>3</sub> (mg/L)	PO <sub>4</sub> (mg/L)	SO <sub>4</sub> (mg/L)
Initial	69.07	37.21	1.29	7.26	8.72	0.00	0.00	20.16
30 min	63.35	34.90	1.23	6.56	5.53	0.14	0.00	17.04
60 min	65.87	36.20	1.24	6.37	5.46	0.16	0.00	16.93
20 min (post)	67.21	36.39	1.22	6.31	5.85	0.16	0.00	17.30
40 min (post)	65.70	36.15	1.29	5.72	5.87	0.12	0.00	17.46
180 min (post)	67.94	36.58	28.40	5.95	7.97	0.23	0.00	18.65

Sample Interval (Oct 04)	pH	Cond. (us/cm)	Temp. (°C)	ORP (mV)	eh
Initial	7.2	1077	15.2	159.1	0.36
30 min	7.13	938	10.7	132.2	0.33
60 min	7.2	936	11	-57	0.14

20 min (post)	7.3	911	10.1	-250.8	-0.05
40 min (post)	7.28	976	12.8	-247	-0.05
180 min (post)	7.31	977	12.2	-171.3	0.03

---

## Location L6

Sample (Jan 31)	Rate (gpm)	Gallons Pumped	As (ug/L)	As 3 (ug/l)	As 3 %	As 5 (ug/L)	As 5 %
Initial	5	0	21.13	18.77	88.83	2.36	11.17

Sample	Date Sampled	pH	Cond. (us/cm)	Temp. (°C)	TDS (ppm)	Alkalinity (mg/L)
Initial	1/31/2019	6.5	655.00	10.10	330.00	336.00

Sample Interval (July 07)	Rate (gpm)	Gallons Pumped	As (ug/L)	As 3 (ug/l)	As 3 %	As 5 (ug/L)	As 5 %
Initial	5	0	19.01	17.22	90.57	1.79	9.43
20 min	5	100	21.12	19.47	92.22	1.64	7.78
40 min	5	200	22.21	20.67	93.06	1.54	6.94
60 min	5	300	31.00	27.08	87.35	3.92	12.65

Sample Interval (July 07)	Ferrous Fe (mg/L)	Ferric Fe (mg/L)	Total Fe (mg/L)
Initial	0.46	2.54	>3
20 min	0.46	2.54	>3
40 min	0.43	2.57	>3
60 min	0.44	2.56	>3

Sample Interval (July 07)	Ca (mg/L)	Mg (mg/L)	K (mg/L)	Na (mg/L)	Cl (mg/L)	NO3 (mg/L)	PO4 (mg/L)	SO4 (mg/L)
Initial	71.88	40.37	0.93	0.47	3.16	n.d.	n.d.	4.10
20 min	70.92	40.04	0.71	0.50	2.18	n.d.	n.d.	3.57
40 min	72.20	39.49	0.74	0.47	1.13	n.d.	n.d.	3.07
60 min	72.21	39.64	0.26	0.47	1.10	n.d.	n.d.	4.73

Sample Interval (July 07)	pH	Cond. (us/cm)	Temp. (°C)	ORP (mV)	eh
Initial	7	1175	16.2	-46.7	0.15

20 min	7.5	1020	12	-50	0.15
40 min	6.5	833	11.7	-49.9	0.15
60 min	7	737	11.8	-43.3	0.16

Sample Interval (Aug 25)	Rate (gpm)	Gallons Pumped	As (ug/L)	As 3 (ug/l)	As 3 %	As 5 (ug/L)	As 5 %
Initial	5	0	6.99	6.36	90.95	0.63	9.05
30 min	5	150	15.06	13.44	89.24	1.62	10.76
60 min	5	300	21.60	18.38	85.10	3.22	14.90
20 min (post)	5	n.a.	20.34	18.67	91.80	1.67	8.20
40 min (post)	5	n.a.	20.33	18.37	90.34	1.96	9.66
180 min (post)	5	n.a.	16.82	14.47	86.04	2.35	13.96

Sample (Aug 25)	Ferrous		Total
	Fe (mg/L)	Ferric Fe (mg/L)	Fe (mg/L)
Initial	2.62	0.38	>3
30 min	1.91	1.09	>3
60 min	3	0	>3
20 min (post)	2.43	0.57	>3
40 min (post)	1.98	1.02	>3
180 min (post)	2.43	0.57	>3

Sample (Aug 25)	Ca (mg/L)	Mg (mg/L)	K (mg/L)	Na (mg/L)	Cl (mg/L)	NO <sub>3</sub> (mg/L)	PO <sub>4</sub> (mg/L)	SO <sub>4</sub> (mg/L)
Initial	70.55	37.99	2.05	1.73	2.01	n.d.	n.d.	3.96
30 min	73.03	39.82	2.05	2.04	2.12	n.d.	n.d.	2.44
60 min	72.28	39.65	2.11	1.53	1.19	n.d.	n.d.	3.69
20 min (post)	71.10	38.69	2.00	0.67	1.16	n.d.	n.d.	3.86
40 min (post)	74.02	39.40	2.05	1.00	1.26	n.d.	n.d.	3.36
180 min (post)	73.43	39.08	2.07	1.02	1.27	n.d.	n.d.	3.62

Sample (Aug 25)	pH	Cond. (us/cm)	Temp. (	ORP (mV)	eh
Initial	7.86	1291	20.5	-146.20	0.05
30 min	7.98	1059	11.8	-161.90	0.04
60 min	7.95	1039	11.4	-161.70	0.04

20 min (post)	7.89	1054	11.7	-145.90	0.05
40 min (post)	7.88	1104	13.9	-151.60	0.05
180 min (post)	7.85	1170	16.2	-126.00	0.07

Sample Interval (Oct 04)	Rate (gpm)	Gallons Pumped	As (ug/L)	As 3 (ug/l)	As 3 %	As 5 (ug/L)	As 5 %
Initial	5	0	17.52	16.18	92.32	1.35	7.68
30 min	5	150	26.54	23.95	90.22	2.60	9.78
60 min	5	300	33.16	28.87	87.07	4.29	12.93
20 min (post)	5	n.a.	27.81	22.99	82.68	4.82	17.32
40 min (post)	5	n.a.	30.51	25.10	82.28	5.41	17.72
180 min (post)	5	n.a.	32.11	25.57	79.65	6.54	20.35

Sample (Oct 04)	Ferrous Fe (mg/L)	Ferric Fe (mg/L)	Total Fe (mg/L)
Initial	3	0	3
30 min	3	0	3
60 min	2.6	0.4	3
20 min (post)	3	0	3
40 min (post)	3	0	3
180 min (post)	3	0	3

Sample (Oct 04)	Ca (mg/L)	Mg (mg/L)	K (mg/L)	Na (mg/L)	Cl (mg/L)	NO <sub>3</sub> (mg/L)	PO <sub>4</sub> (mg/L)	SO <sub>4</sub> (mg/L)
Initial	69.47	37.21	1.15	6.58	1.59	0.00	0.00	3.21
30 min	70.46	34.90	0.99	6.31	1.21	0.00	0.00	3.99
60 min	67.18	36.20	1.08	6.11	1.08	0.00	0.00	4.84
20 min (post)	70.19	36.39	0.98	5.94	1.07	0.00	0.00	4.87
40 min (post)	69.54	36.15	1.01	5.79	1.06	0.00	0.00	4.75
180 min (post)	69.78	36.58	0.91	5.66	1.09	0.00	0.00	4.94

Sample (Oct 04)	pH	Cond. (us/cm)	Temp. (°C)	ORP (mV)	eh
Initial	7.47	1045	12.8	-44.00	0.16
30 min	7.51	993	10.9	-60.50	0.14

60 min	7.55	991	10.9	-	133.90	0.07
20 min (post)	7.55	1005	11.3	-	168.50	0.03
40 min (post)	7.54	1019	12	-	173.10	0.03
180 min (post)	7.31	1064	13.1	-	-39.50	0.16

Sample Interval (Oct 10)	Rate (gpm)	Gallons Pumped	As (ug/L)	As 3 (ug/l)	As 3 %	As 5 (ug/L)	As 5 %
Initial	5	0	16.27	14.81	91.00	1.46	9.00
30 min	5	150	26.48	23.33	88.11	3.15	11.89
60 min	5	300	31.62	26.90	85.06	4.73	14.94
20 min (post)	5	n.a.	29.04	25.07	86.36	3.96	13.64
40 min (post)	5	n.a.	24.83	22.22	89.49	2.61	10.51
180 min (post)	5	n.a.	23.63	19.30	81.66	4.33	18.34

Sample (Oct 10)	Ferrous Fe (mg/L)	Ferric Fe (mg/L)	Total Fe (mg/L)
Initial	3	0	3
30 min	3	0	3
60 min	3	0	3
20 min (post)	3	0	3
40 min (post)	3	0	3
180 min (post)	3	0	3

Sample (Oct 10)	Ca (mg/L)	Mg (mg/L)	K (mg/L)	Na (mg/L)	Cl (mg/L)	NO <sub>3</sub> (mg/L)	PO <sub>4</sub> (mg/L)	SO <sub>4</sub> (mg/L)
Initial	72.90	39.13	2.62	14.92	0.74	0.80	0.88	0.67
30 min	73.99	39.76	2.65	13.42	0.16	0.18	0.46	0.22
60 min	75.10	39.22	2.41	13.96	1.02	0.00	0.00	4.72
20 min (post)	73.36	39.30	2.15	14.83	1.08	0.00	0.00	4.61
40 min (post)	74.65	38.78	2.00	13.02	1.05	0.00	0.00	4.65
180 min (post)	74.84	39.00	2.12	14.65	1.14	0.00	0.00	4.61

Sample (Oct 10)	pH	Cond. (us/cm)	Temp. (°C)	ORP (mV)	eh
Initial	7.49	1091	14.1	-38.60	0.16
30 min	7.49	1002	11.1	-27.30	0.17
60 min	7.49	999	11	-22.90	0.18
20 min (post)	7.51	1032	12.1	-12.80	0.19
40 min (post)	7.47	1060	13.5	-8.80	0.19
180 min (post)	7.44	1133	16.1	35.00	0.24

## Location L9

Sample Round	Date Sampled	Arsenic (ug/L) (ug/L)	As 3 (ug/l)	As 5 (ug/L)
1	2/28/2019	39.77	32.75	7.02

Sample Round	pH	Conductivity (us/cm)	Temperature (°C)	TDS (ppm)	ORP (mV)
1	6.50	551.00	11.10	278.00	n.a.

Sample Interval (July 12)	Rate (gpm)	Gallons Pumped	As (ug/L)	As 3 (ug/l)	As 3 %	As 5 (ug/L)	As 5 %
Initial	7	0	7.66	6.42	83.82	1.24	16.18
20 min	7	140	7.59	6.60	86.96	0.99	13.04
40 min	7	280	9.97	8.37	83.88	1.61	16.12
60 min	7	420	9.74	8.64	88.69	1.10	11.31

Sample (July 12)	Ferrous Fe (mg/L)	Ferric Fe (mg/L)	Total Fe (mg/L)
Initial	0.7	0.03	0.73
20 min	0.73	0.02	0.75
40 min	0.68	0	0.68
60 min	0.87	0	0.73

Sample (July 12)	Ca (mg/L)	Mg (mg/L)	K (mg/L)	Na (mg/L)	Cl (mg/L)	NO3 (mg/L)	PO4 (mg/L)	SO4 (mg/L)
Initial	49.03	38.97	2.85	0.38	1.06	n.d.	n.d.	2.19
20 min	48.85	39.26	3.06	0.35	1.07	0.24	n.d.	2.16
40 min	49.04	36.67	2.53	0.37	1.17	n.d.	n.d.	2.14
60 min	48.67	39.46	2.87	0.37	1.08	n.d.	n.d.	2.17

Sample (July 12)	pH	Cond. (us/cm)	Temp. (°C)	ORP (mV)	eh
Initial	7.83	868	10.8	-76.2	0.12
20 min	7.87	861	10.7	-109.5	0.09
40 min	7.84	827	11	-113.6	0.09
60 min	7.87	873	10.9	-113.3	0.09

## Location L12

<b>Sample</b>	<b>Date Sampled</b>	<b>As (ug/L)</b>	<b>As 3 (ug/l)</b>	<b>As 3 %</b>	<b>As 5 (ug/L)</b>	<b>As 5 %</b>
Well	2/7/2019	0.24	0.17	70.20	0.07	29.80
Tap	2/7/2019	0.28	0.17	62.95	0.10	37.05

<b>Sample</b>	<b>Date Sampled</b>	<b>pH</b>	<b>Cond. (us/cm)</b>	<b>Temp. (°C)</b>	<b>TDS (ppm)</b>
Well	2/7/2019	6.5	939	11.6	473

### Location L13

Sample Round	Date Sampled	Arsenic (ug/L)	As 3 (ug/l)	As 3%	As 5 (ug/L)	As 5%
1	3/1/2019	8.05	6.36	78.99	1.69	21.01
2	9/9/2019	9.28	10.31	100.00	0.00	0.00

Sample Round	pH	Conductivity (us/cm)	Temperature (°C)	TDS (ppm)	ORP (mV)	Fe 2+ (mg/L)	Total Fe (mg/L)
1	7.00	1087.00	11.80	548.00	n.a.	n.a.	n.a.
2	7.22	1744.00	13.30	n.a.	-51.10	1.70	1.70

Sample Round	Ca (mg/L)	Mg (mg/L)	K (mg/L)	Na (mg/L)	Cl (mg/L)	NO3 (mg/L)	PO4 (mg/L)	SO4 (mg/L)
1	109.83	67.58	0.74	12.94	110.46	n.d.	n.d.	65.81
2	105.42	67.12	0.80	0.66	83.75	n.d.	0.20	68.37

## Location L14

Sample Round	Date Sampled	Arsenic (ug/L)	As 3 (ug/l)	As 3%	As 5 (ug/L)	As 5%
1	3/1/2019	12.74	5.81	45.57	0.26	54.43
2	9/9/2019	10.86	6.77	62.27	4.10	37.73

Sample Round	pH	Conductivity (us/cm)	Temperature (°C)	TDS (ppm)	ORP (mV)	Fe 3+ (mg/L)	Total Fe (mg/L)
1	6.50	707.00	12.30	352.00	n.a.	n.a.	n.a.
2	7.76	1089.00	11.70	n.a.	86.40	0.66	0.66

Sample Round	Ca (mg/L)	Mg (mg/L)	K (mg/L)	Na (mg/L)	Cl (mg/L)	NO3 (mg/L)	PO4 (mg/L)	SO4 (mg/L)
1	65.76	52.25	0.21	7.69	41.13	1.81	n.d.	30.79
2	63.12	51.75	0.14	0.46	11.34	1.21	n.d.	23.99

## Location L15

Sample Round	Date Sampled	As (ug/L)	As 3 (ug/l)	As 5 (ug/L)
1	3/7/2019	764.83	655.46	109.37

Sample Round	pH	Cond. (us/cm)	Temp. (°C)	TDS (ppm)	ORP (mV)
1	6.50	696.00	11.60	352.00	n.a.

Sample Round	Ca (mg/L)	Mg (mg/L)	K (mg/L)	Na (mg/L)	Cl (mg/L)	NO3 (mg/L)	PO4 (mg/L)	SO4 (mg/L)
1	84.44	42.29	1.35	2.85	1.10	n.d.	n.d.	81.01

Sample (June 30)	Ferrous Fe (mg/L)	Ferric Fe (mg/L)	Total Fe (mg/L)
Initial	1.96	0.92	2.88
20 min	2.94	0	2.21
40 min	3	0	3
60 min	3	0	3

Sample (June 30)	Ca (mg/L)	Mg (mg/L)	K (mg/L)	Na (mg/L)	Cl (mg/L)	NO3 (mg/L)	PO4 (mg/L)	SO4 (mg/L)
Initial	79.32	40.16	0.65	0.22	0.78	n.d.	n.d.	43.15
20 min	77.69	39.94	0.56	0.22	0.62	n.d.	n.d.	30.40
40 min	78.87	40.09	0.33	0.20	0.67	n.d.	n.d.	31.41
60 min	73.45	39.87	0.04	0.19	0.66	n.d.	n.d.	29.89

Sample (June 30)	pH	Cond. (us/cm)	Temp. (°C)	ORP (mV)	eh
Initial	7.05	1039	12.7	-97.8	0.10
20 min	7.09	687	12.3	-101.2	0.10
40 min	na*	na*	na*	-84.3	0.12
60 min	na*	na*	na*	-75.9	0.12

## Location L16

Sample Round	Date Sampled	As (ug/L)	As 3 (ug/l)	As 5 (ug/L)
1	3/15/2019	17.80	14.57	3.23

Sample Round	pH	Cond. (us/cm)	Temp. (°C)	TDS (ppm)	ORP (mV)
1	6.50	945.00	12.40	485.00	n.a.

Sample Round	Ca (mg/L)	Mg (mg/L)	K (mg/L)	Na (mg/L)	Cl (mg/L)	NO3 (mg/L)	PO4 (mg/L)	SO4 (mg/L)
1	78.68	57.88	1.30	35.17	209.97	7.52	n.d.	33.24

Sample (Jun 30)	Rate (gpm)	Gallons Pumped	As (ug/L)	As 3 (ug/l)	As 3 %	As 5 (ug/L)	As 5 %
Initial	4	0	17.84	16.31	91.43	1.53	8.57
20 min	4	80	19.68	17.67	89.79	2.01	10.21
40 min	4	160	18.67	18.03	96.58	0.64	3.42
60 min	4	240	18.10	16.39	90.52	1.72	9.48

Sample (June 30)	Ferrous Fe (mg/L)	Ferric Fe (mg/L)	Total Fe (mg/L)
Initial	1.35	0	1.01
20 min	1.31	0	1.04
40 min	1.12	0	1
60 min	0.99	0.12	1.11

Sample (June 30)	Ca (mg/L)	Mg (mg/L)	K (mg/L)	Na (mg/L)	Cl (mg/L)	NO3 (mg/L)	PO4 (mg/L)	SO4 (mg/L)
Initial	78.99	59.39	0.49	2.32	58.66	n.d.	n.d.	53.58
20 min	80.89	60.54	0.29	2.37	61.87	n.d.	n.d.	55.26
40 min	79.90	60.52	n.d.	2.39	60.59	n.d.	n.d.	54.41
60 min	79.33	60.26	n.d.	2.36	60.55	n.d.	n.d.	54.27

Sample (June 30)	pH	Cond. (us/cm)	Temp. (°C)	ORP (mV)	eh
Initial	7.35	1667	14.2	-72.8	0.13
20 min	7.35	921	12.8	-85.7	0.11
40 min	7.36	828	12.3	-91.2	0.11
60 min	7.38	1587	12.4	-89.6	0.11

## Location L17

Sample	Date Sampled	As (ug/L)	As 3 (ug/l)	As 3 %	As 5 (ug/L)	As 5 %
Well	3/18/2019	0.11	0.78	100.00	0.00	0.00

Sample	Ca (mg/L)	Mg (mg/L)	K (mg/L)	Na (mg/L)	Cl (mg/L)	NO3 (mg/L)	PO4 (mg/L)	SO4 (mg/L)
Well	58.01	25.68	3.30	47.13	76.81	31.52	n.d.	74.81

Sample	pH	Cond. (us/cm)	Temp. (°C)	TDS (ppm)
Well	6.5	939	11.6	473

## Location L18

Sample Round	Date Sampled	As (ug/L)	As 3 (ug/l)	As 5 (ug/L)
1	3/18/2019	51.17	41.08	10.09

Sample Round	pH	Cond. (us/cm)	Temp. (°C)	TDS (ppm)	ORP (mV)
1	6.75	725.00	12.40	363.00	n.a.

Sample Round	Ca (mg/L)	Mg (mg/L)	K (mg/L)	Na (mg/L)	Cl (mg/L)	NO3 (mg/L)	PO4 (mg/L)	SO4 (mg/L)
1	77.89	33.32	2.24	18.76	74.38	40.46	n.d.	72.89

Sample Interval (Jun 21)	Rate (gpm)	Gallons Pumped	As (ug/L)	As 3 (ug/l)	As 3 %	As 5 (ug/L)	As 5 %
Initial	5	0	44.37	38.88	87.62	5.49	12.38
20 min	5	100	49.09	43.54	88.69	5.55	11.31
40 min	5	200	48.60	42.39	87.23	6.20	12.77
60 min	5	300	48.28	40.32	83.51	7.96	16.49

Sample (June 21)	Ferrous Fe (mg/L)	Ferric Fe (mg/L)	Total Fe (mg/L)
Initial	0.6	0	0.6
20 min	0.55	0.01	0.56
40 min	0.56	0.07	0.63
60 min	0.51	0.01	0.52

Sample (June 21)	Ca (mg/L)	Mg (mg/L)	K (mg/L)	Na (mg/L)	Cl (mg/L)	NO3 (mg/L)	PO4 (mg/L)	SO4 (mg/L)
Initial	80.53	34.01	0.76	0.80	21.48	n.d.	n.d.	51.35
20 min	81.12	33.81	0.59	0.78	19.85	n.d.	n.d.	51.49
40 min	79.96	30.76	0.38	0.77	18.80	n.d.	n.d.	51.10
60 min	80.14	33.78	2.23	0.74	19.17	n.d.	n.d.	50.98

Sample (June 21)	pH	Cond. (us/cm)	Temp. (°C)	ORP (mV)	eh
Initial	7.29	1166	12.6	-36.6	0.16
20 min	7.31	1111	11.7	-46.4	0.15
40 min	7.3	1119	11.7	-50.2	0.15
60 min	7.32	1116	11.6	-54.2	0.15

## Location L19

Sample	Date Sampled	As (ug/L)	As 3 (ug/l)	As 3 %	As 5 (ug/L)	As 5 %
Well	3/19/2019	0.20	0.85	100.00	0.00	0.00

Sample	Ca (mg/L)	Mg (mg/L)	K (mg/L)	Na (mg/L)	Cl (mg/L)	NO3 (mg/L)	PO4 (mg/L)	SO4 (mg/L)
Well	89.31	39.14	1.89	112.39	71.81	n.d.	n.d.	70.22

Sample	pH	Cond. (us/cm)	Temp. (°C)	TDS (ppm)
Well	6.75	1280	12.2	638

## Location L20

Sample	Date Sampled	As (ug/L)	As 3 (ug/l)	As 3 %	As 5 (ug/L)	As 5 %
Well	4/26/2019	0.51	1.40	100.00	0.00	0.00

Sample	Ca (mg/L)	Mg (mg/L)	K (mg/L)	Na (mg/L)	Cl (mg/L)	NO3 (mg/L)	PO4 (mg/L)	SO4 (mg/L)
Well	78.50	37.88	0.77	3.45	14.56	1.49	n.d.	24.39

Sample	pH	Cond. (us/cm)	Temp. (°C)	TDS (ppm)
Well	7	647	12.6	325

## **APPENDIX B:**

### **Additional Analytical Figures**

# All Locations

## pH vs Arsenic

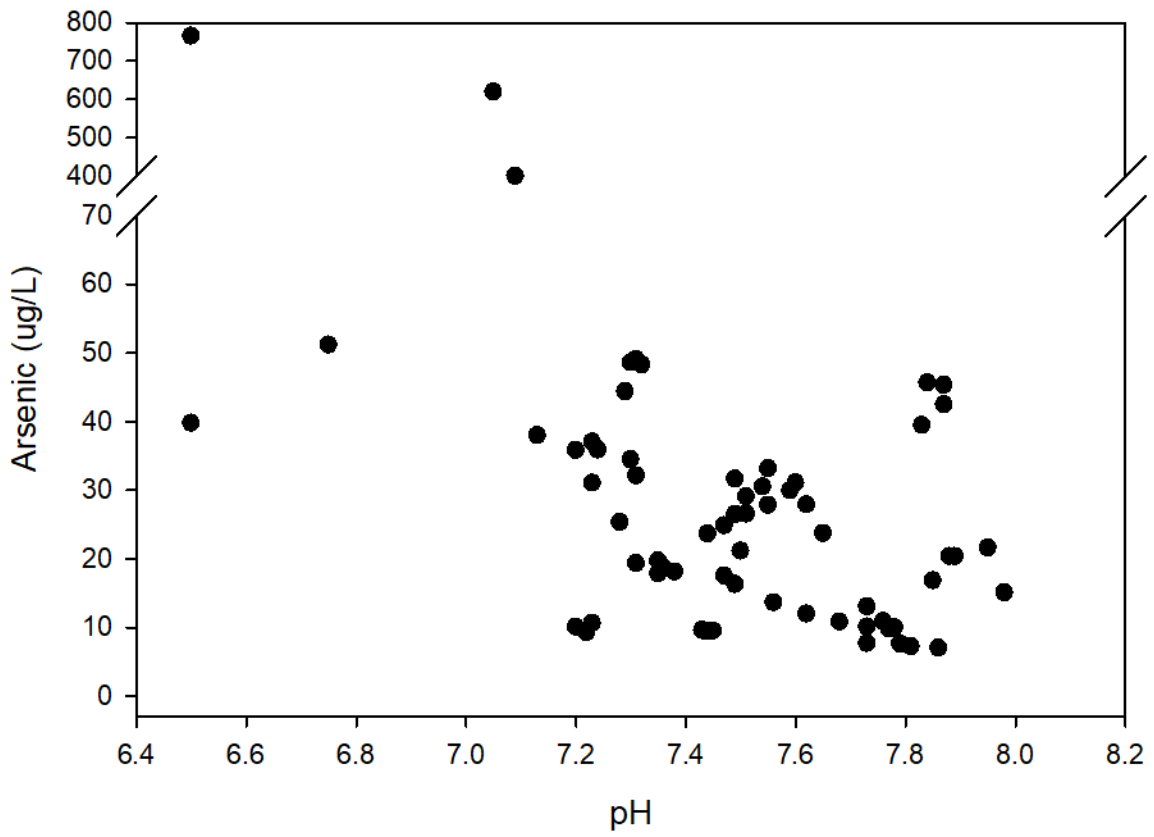







Eh vs Arsenic(V)

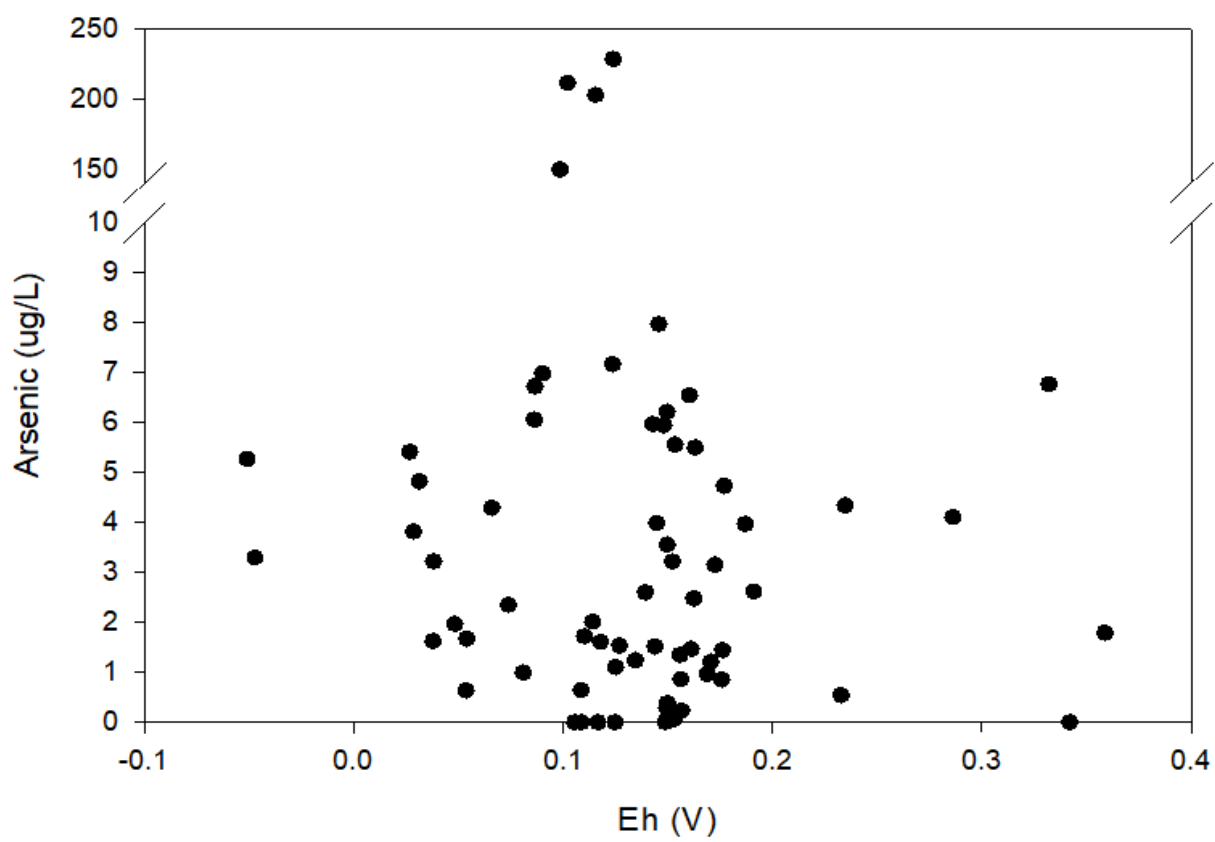

Sulfate vs Arsenic

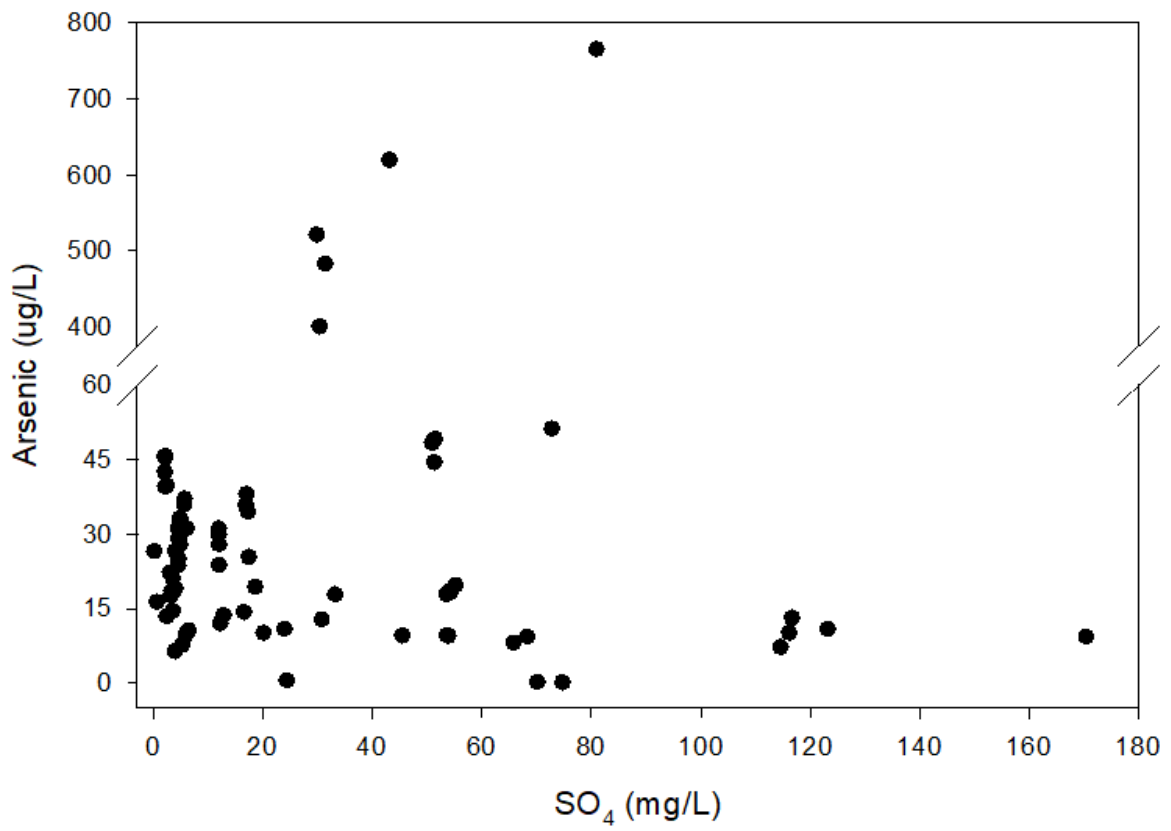

Ferrous Iron vs Arsenic

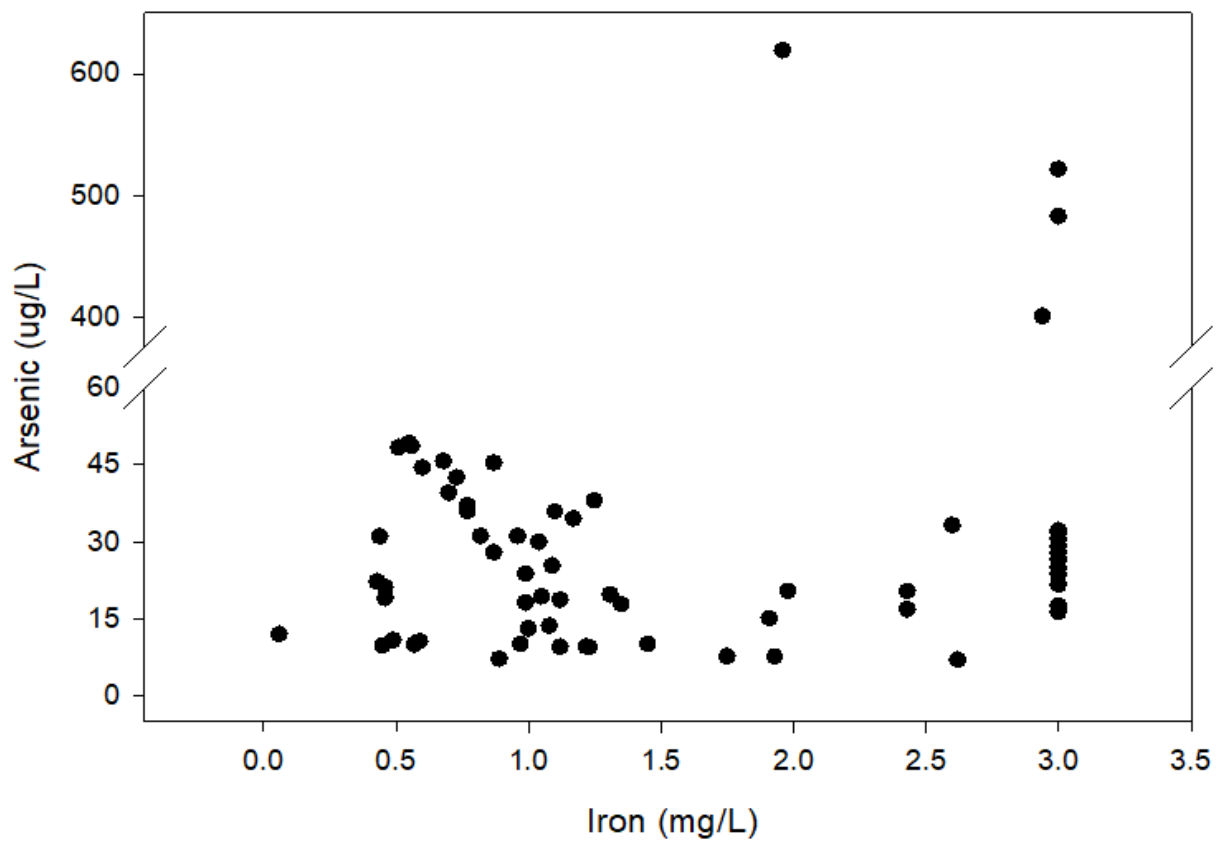

### % As(III) vs Wells

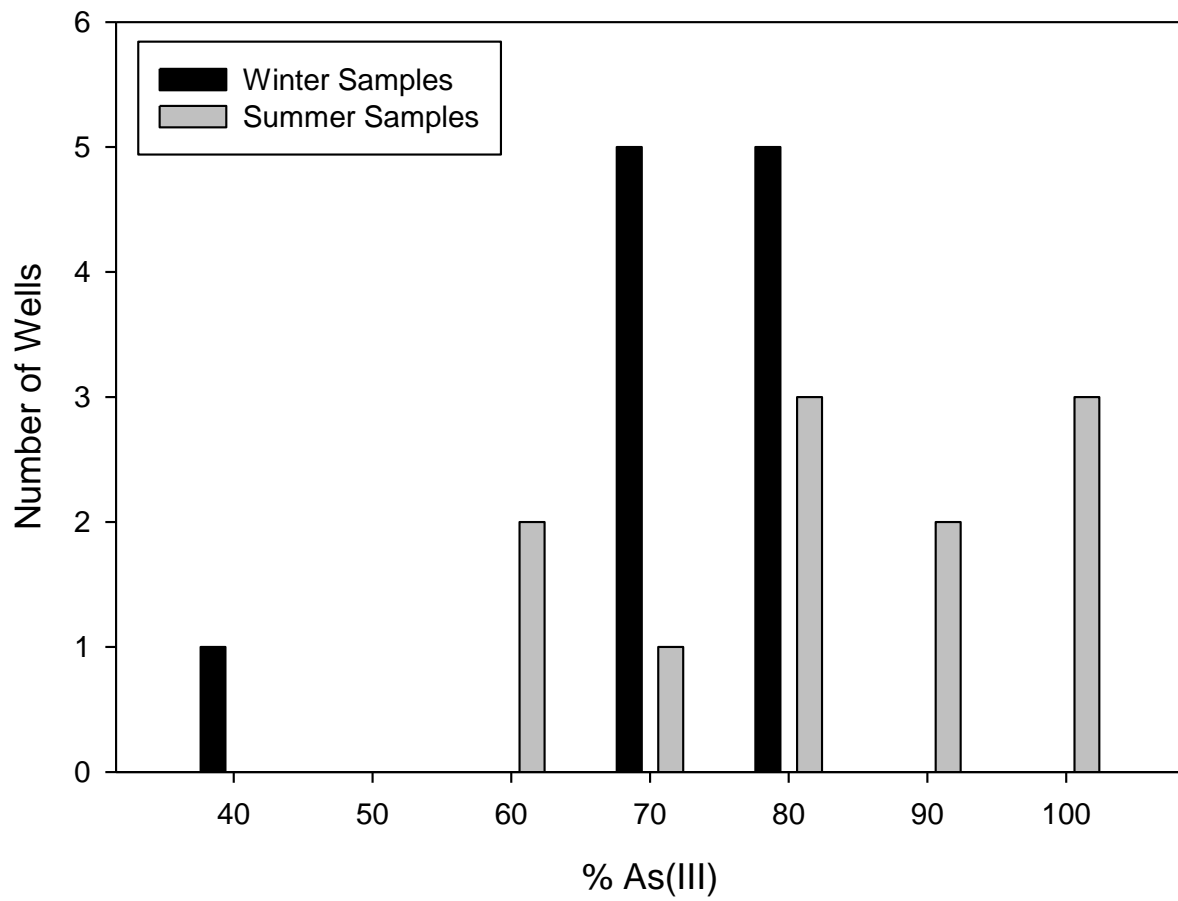

### Seasonal Arsenic Variation

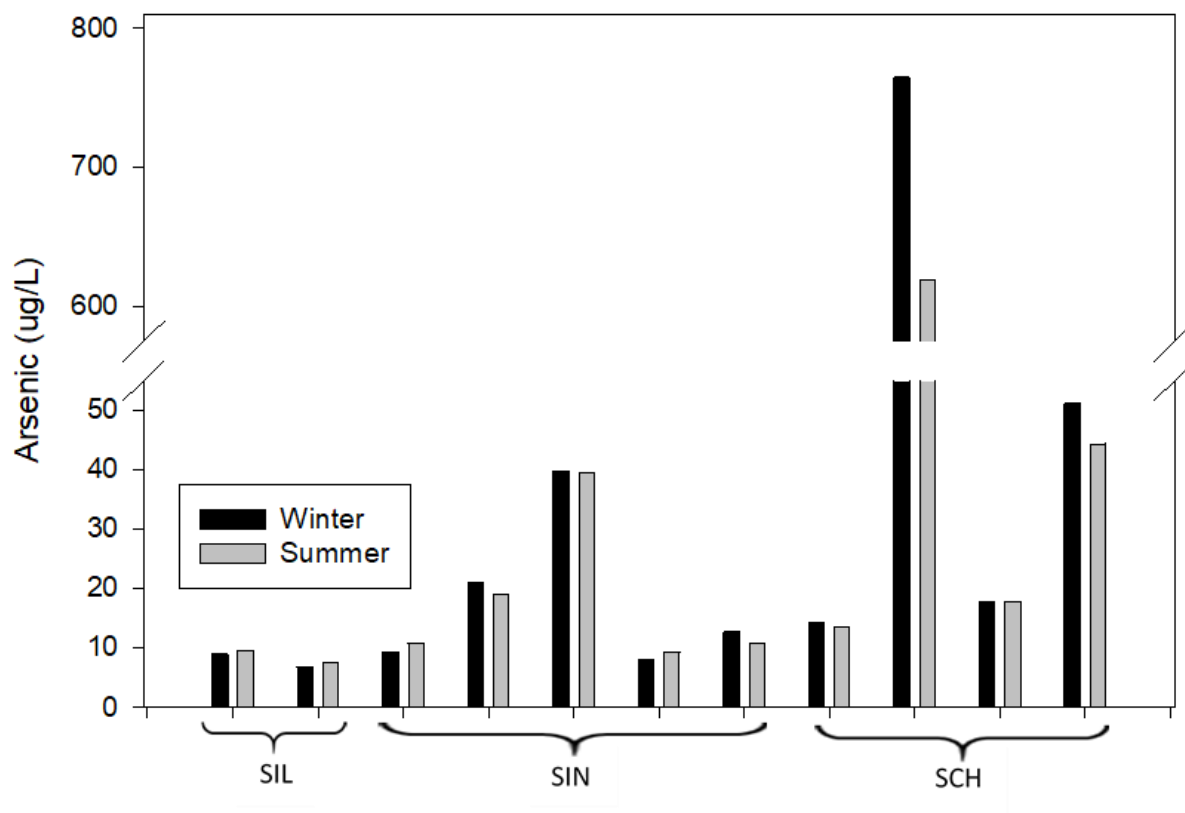

### Arsenic Pump Tests: Overlay

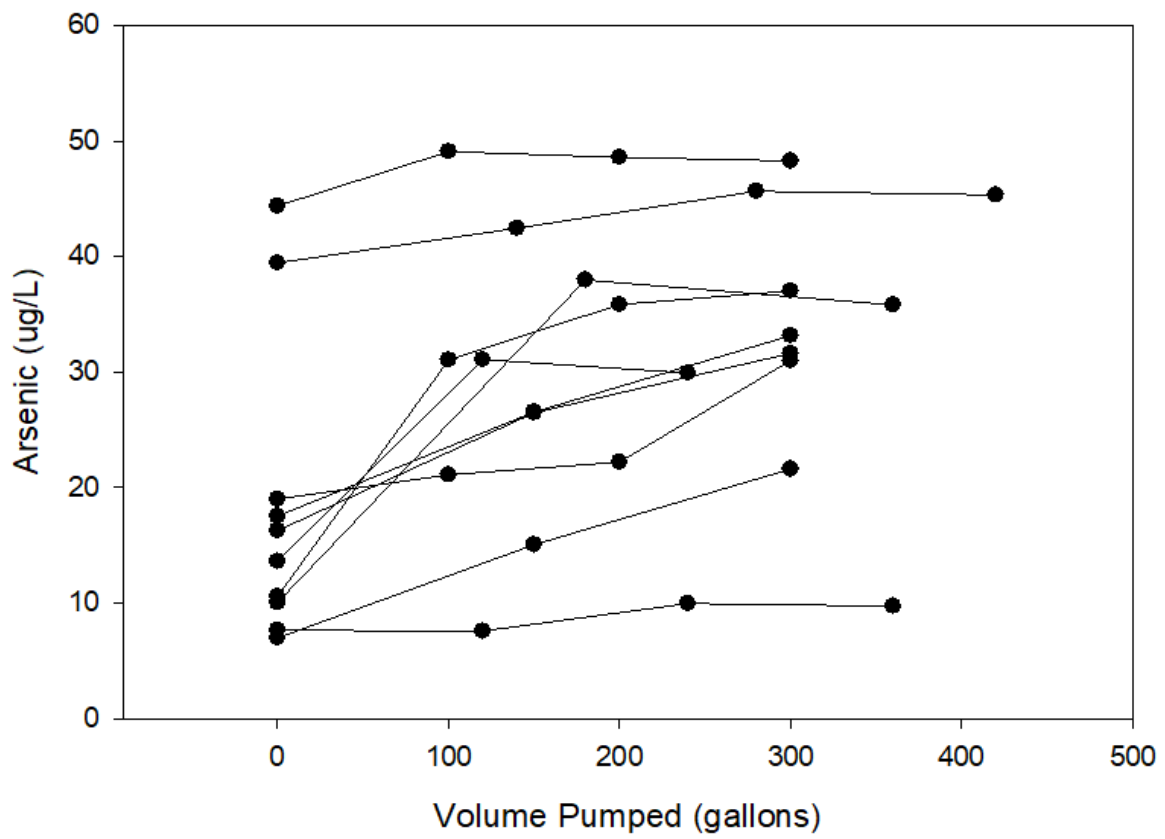

Pumping vs As(V) %

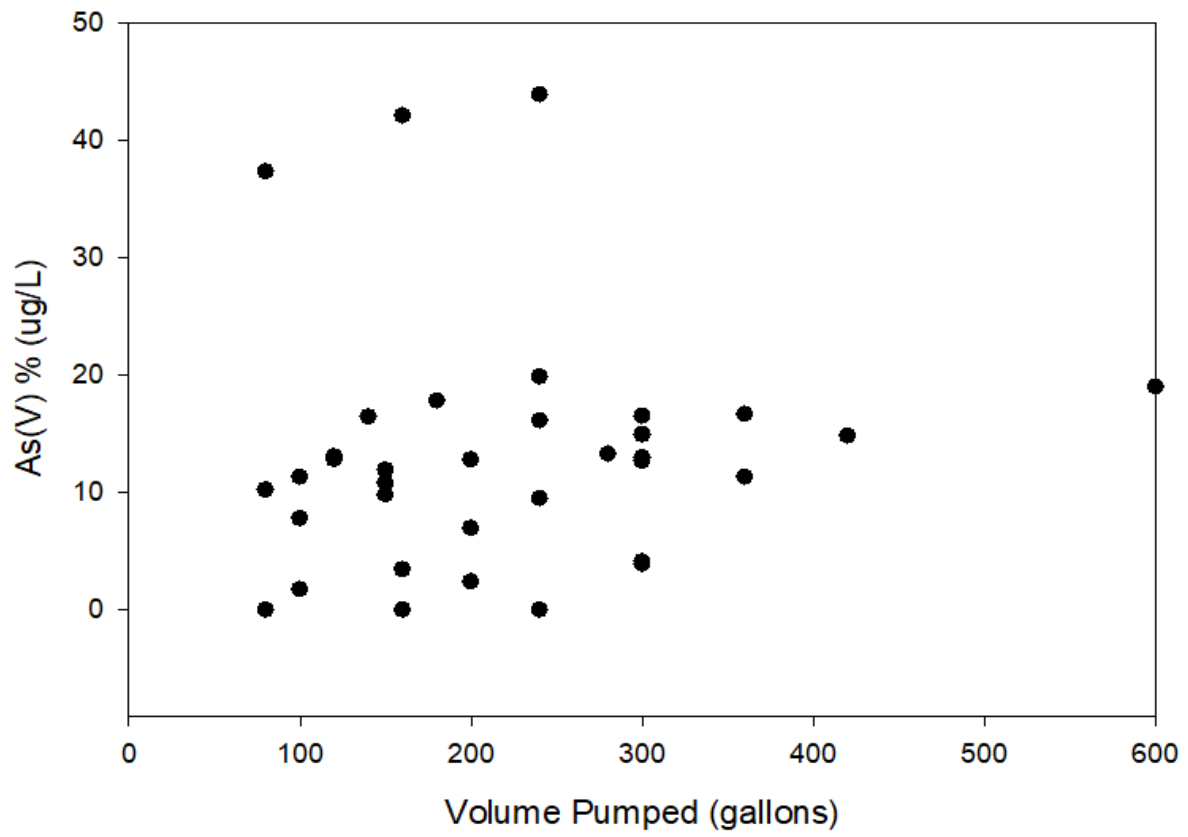

### Post-Pump Arsenic Concentrations

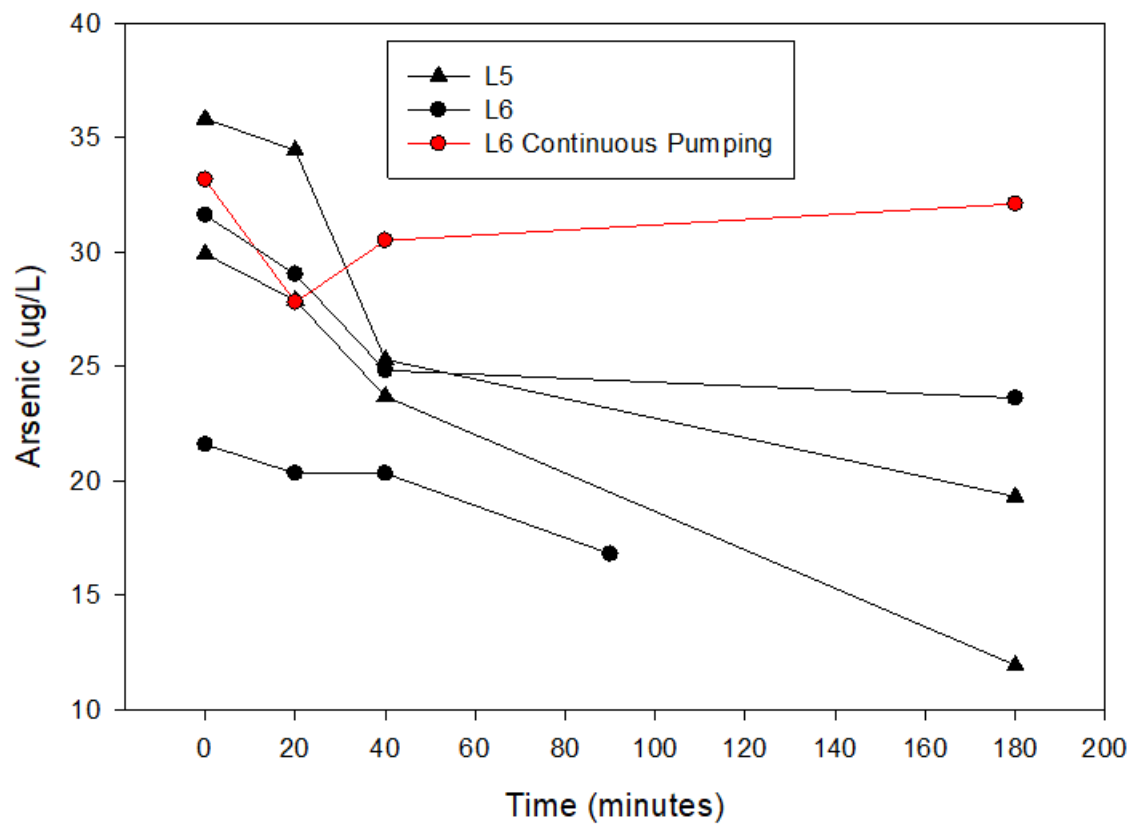

### Post-Pump As(III) %

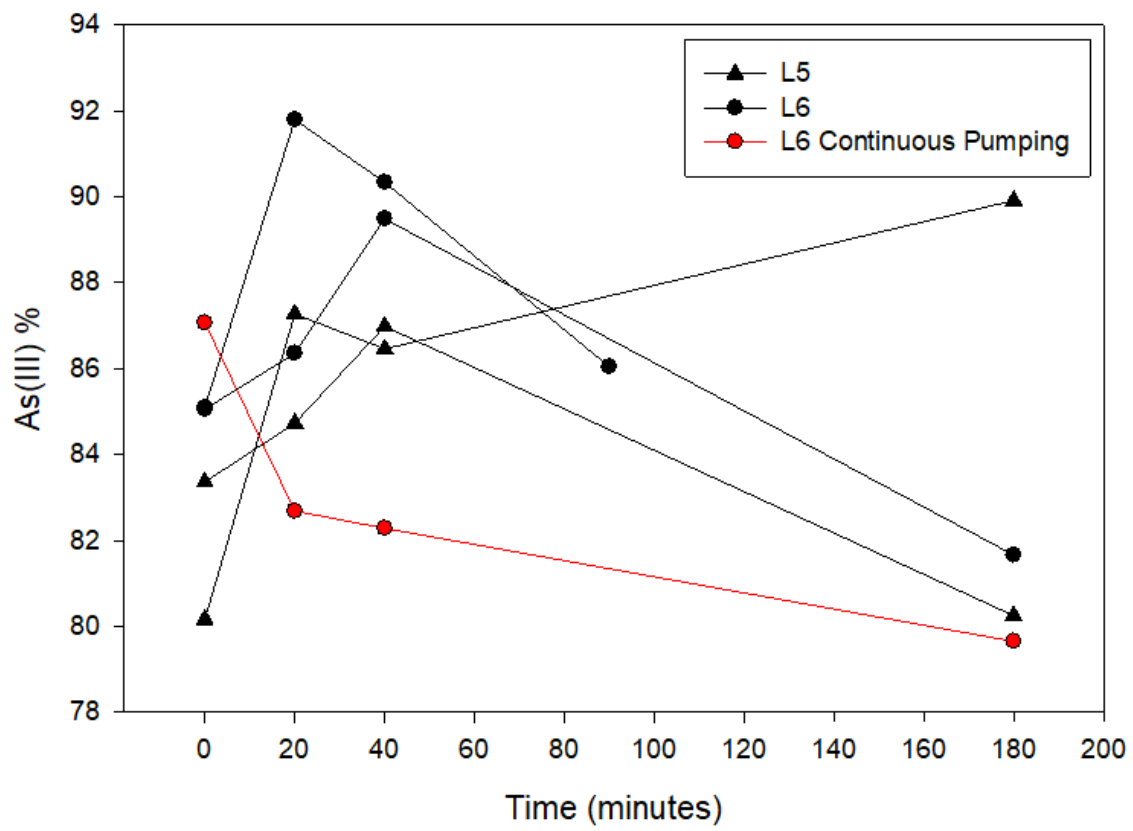

## Detection Summary

Client: University of Wisconsin - Milwaukee  
 Project/Site: Arsenic Testing

Job ID: 500-165576-1

### Client Sample ID: 061519001

### Lab Sample ID: 500-165576-1

Analyte	Result	Qualifier	LOQ	LOD	Unit	Dil Fac	D	Method	Prep Type
Arsenic	35.0	B	1.0	0.23	ug/L	1		6020A	Total/NA

### Client Sample ID: 061519002

### Lab Sample ID: 500-165576-2

Analyte	Result	Qualifier	LOQ	LOD	Unit	Dil Fac	D	Method	Prep Type
Arsenic	35.0	B	1.0	0.23	ug/L	1		6020A	Total/NA

### Client Sample ID: 061519003

### Lab Sample ID: 500-165576-3

Analyte	Result	Qualifier	LOQ	LOD	Unit	Dil Fac	D	Method	Prep Type
Arsenic	35.8	B	1.0	0.23	ug/L	1		6020A	Total/NA

## Individual Locations

### Location L1: Seasonal Arsenic Speciation

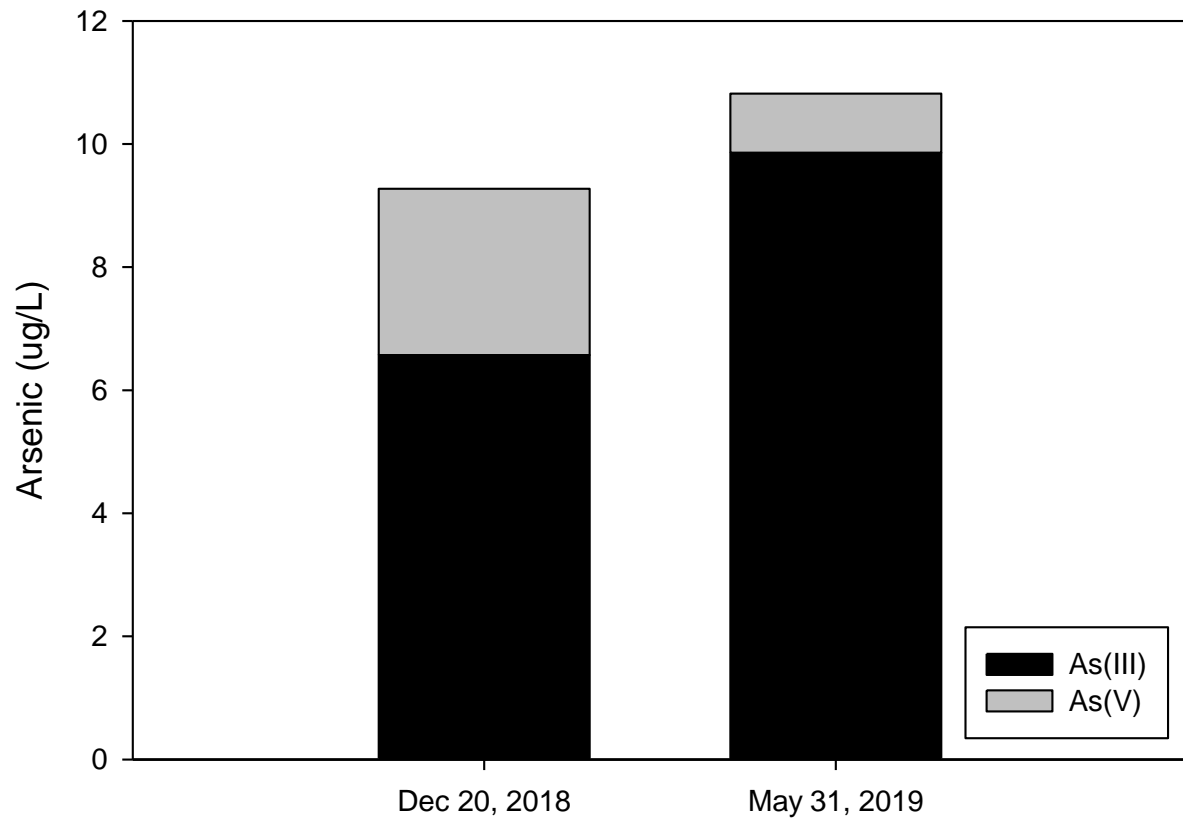

Location L1 Dynamics: Arsenic & Eh

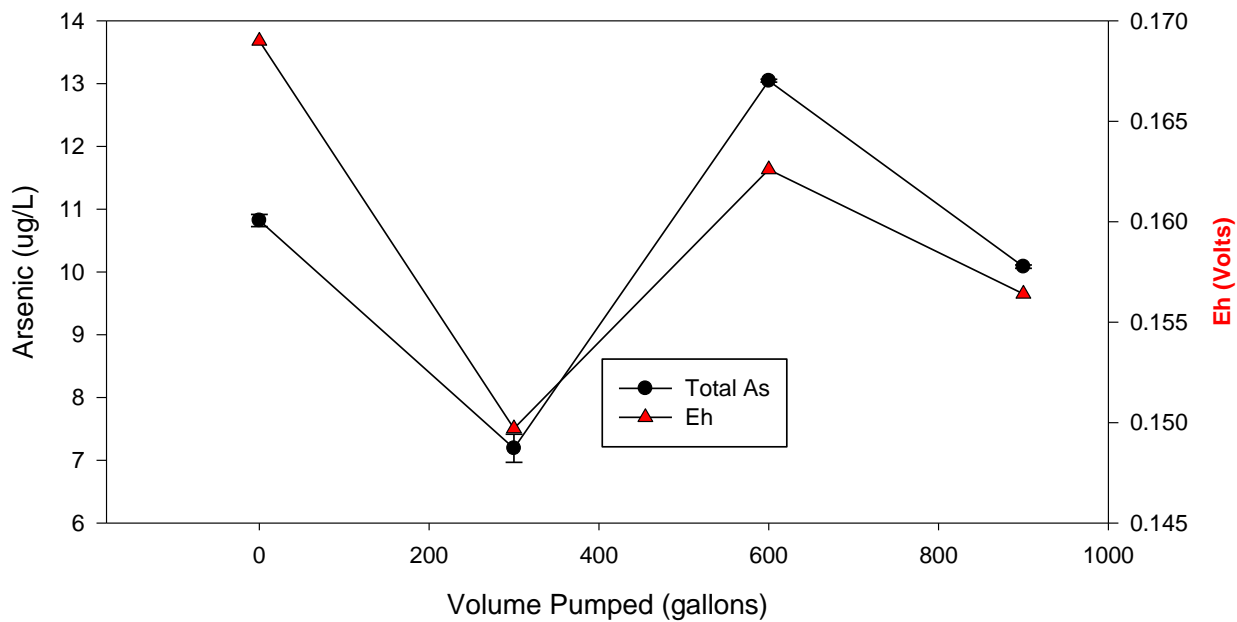

Location L1 Dynamics: Arsenic(V) & Eh

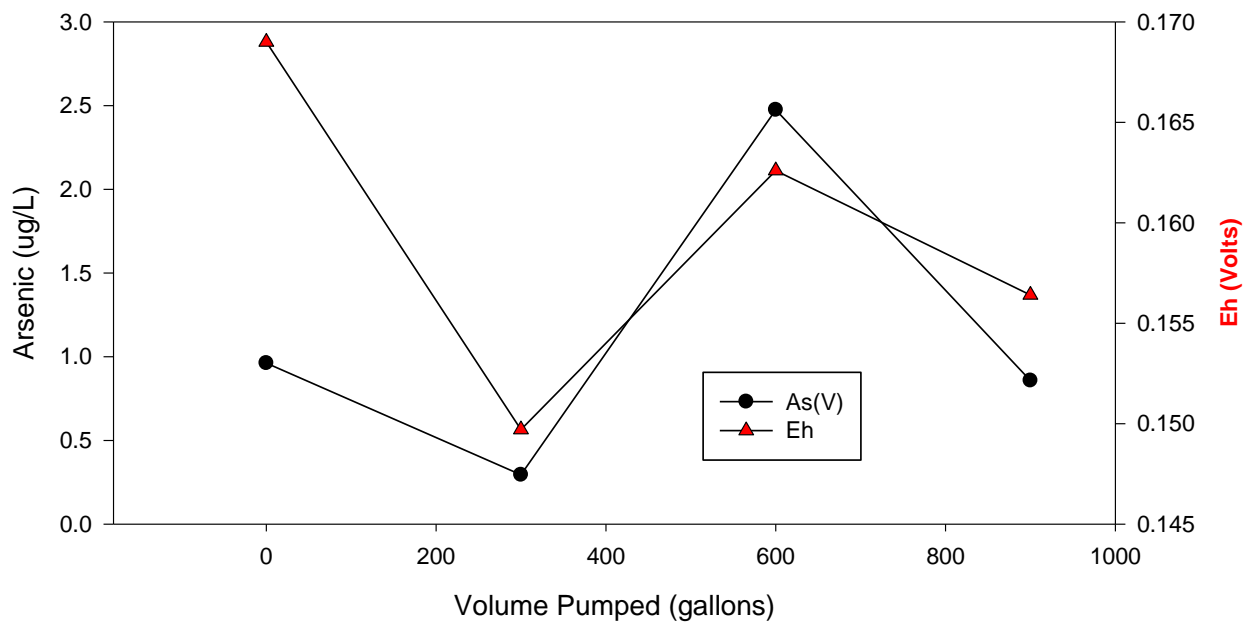

### Location L1 Dynamics: Arsenic & Iron

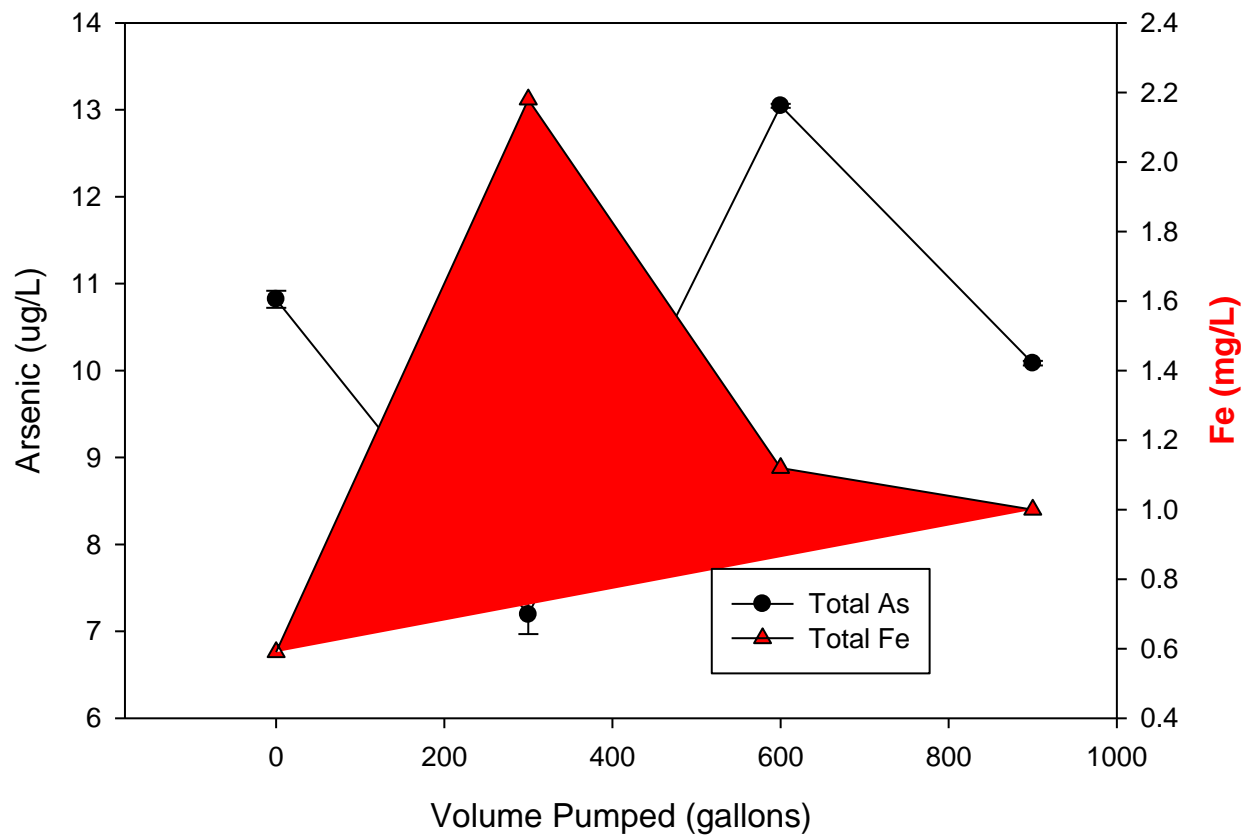

### Seasonal Arsenic: Location L2

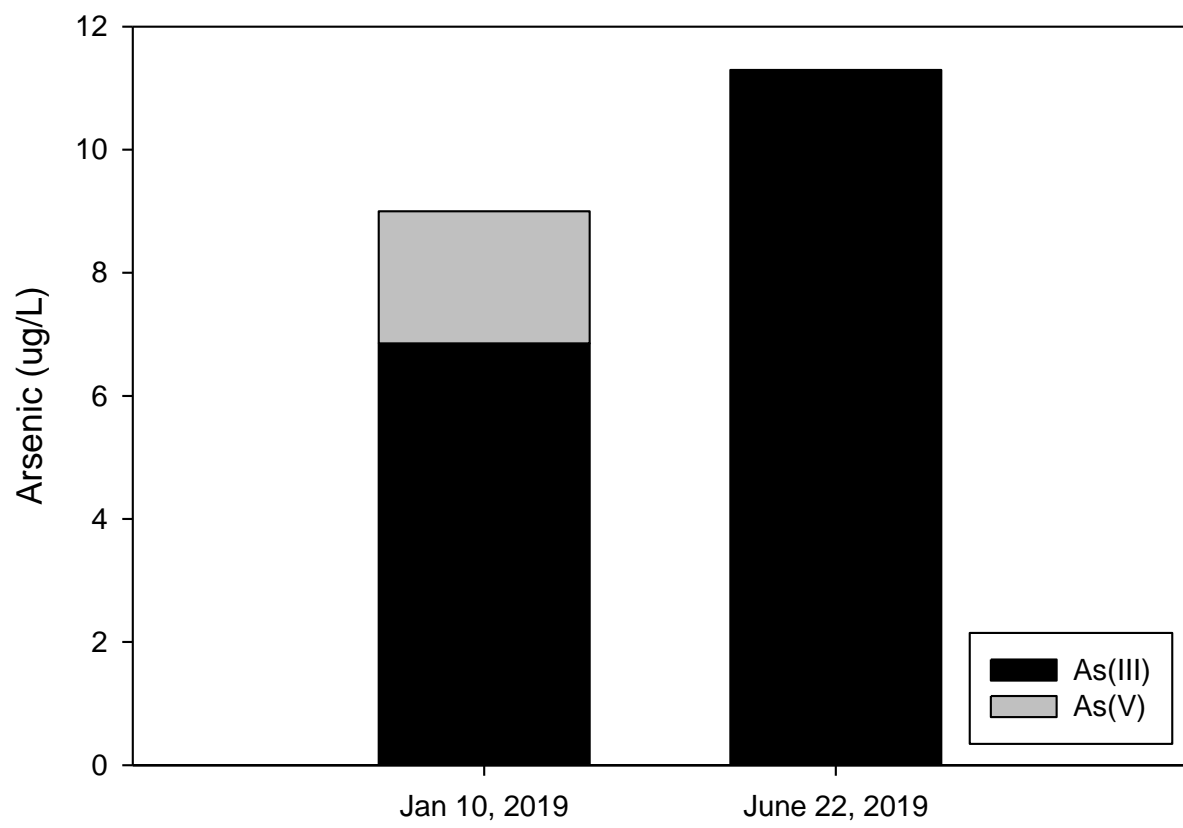

### Seasonal Arsenic: Location L3

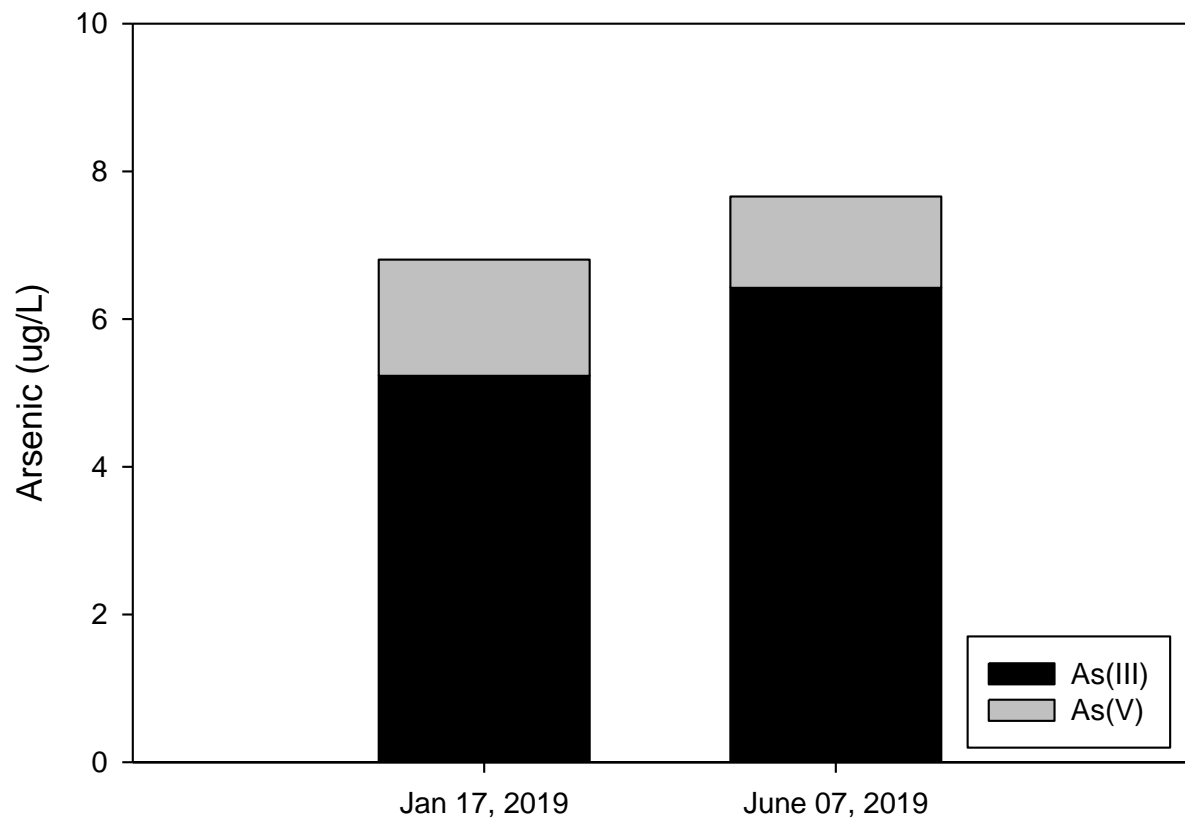

### Location L3 Dynamics: Arsenic & Iron

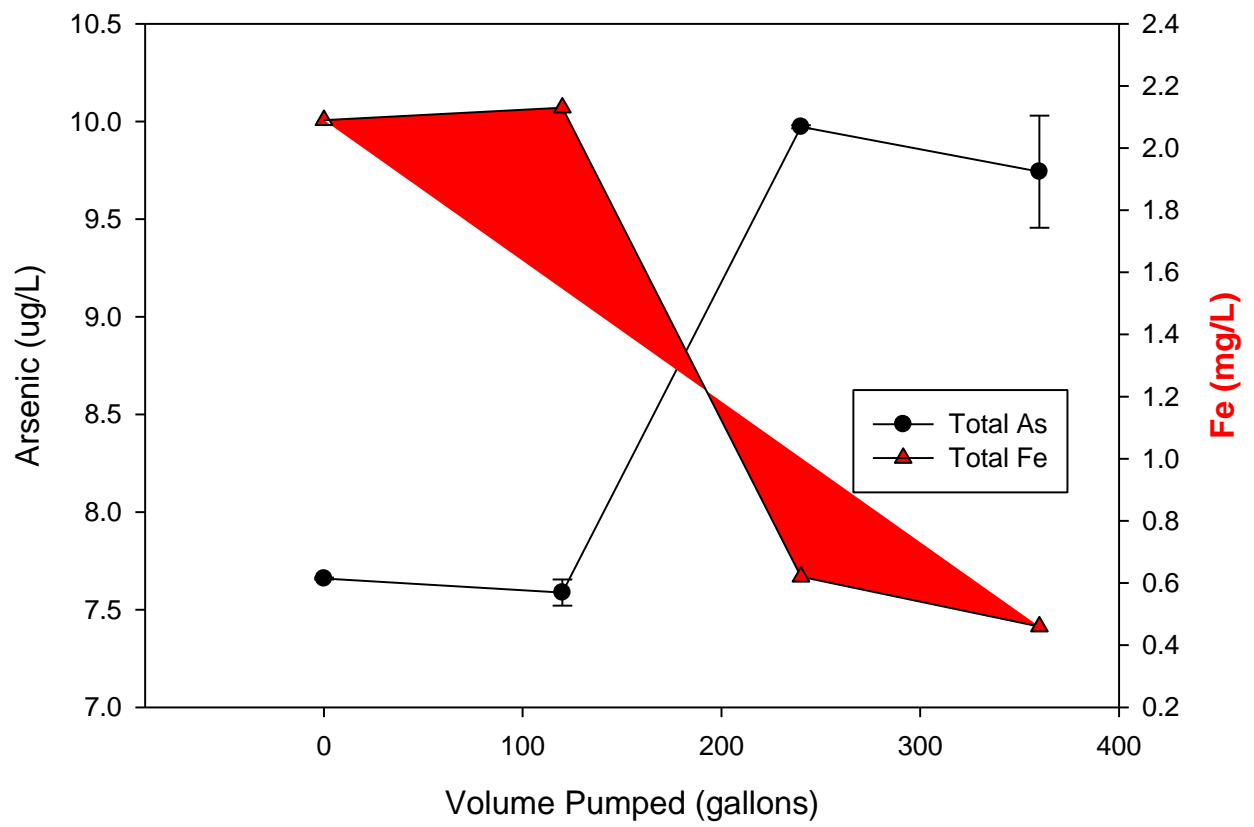

### Seasonal Arsenic: Location L5

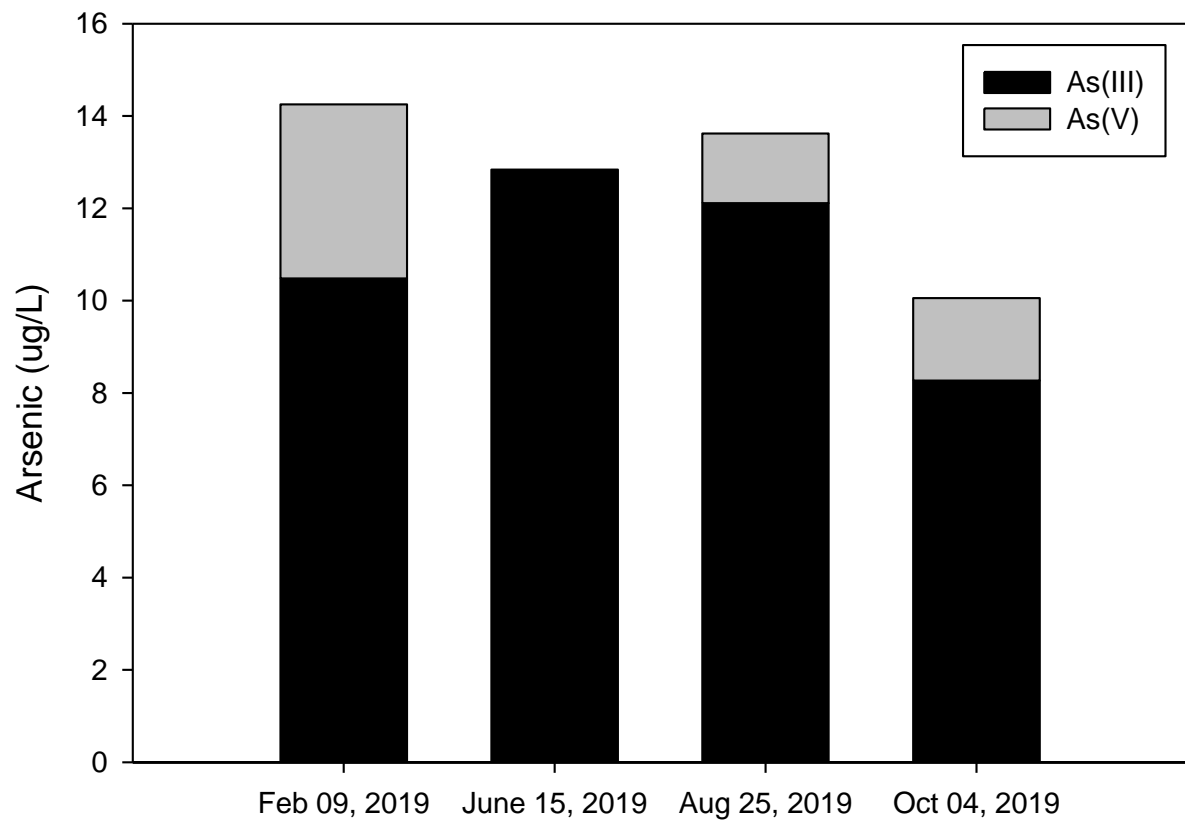

Location L5 Dynamics: Arsenic(V) & Sulfate (Test 1)

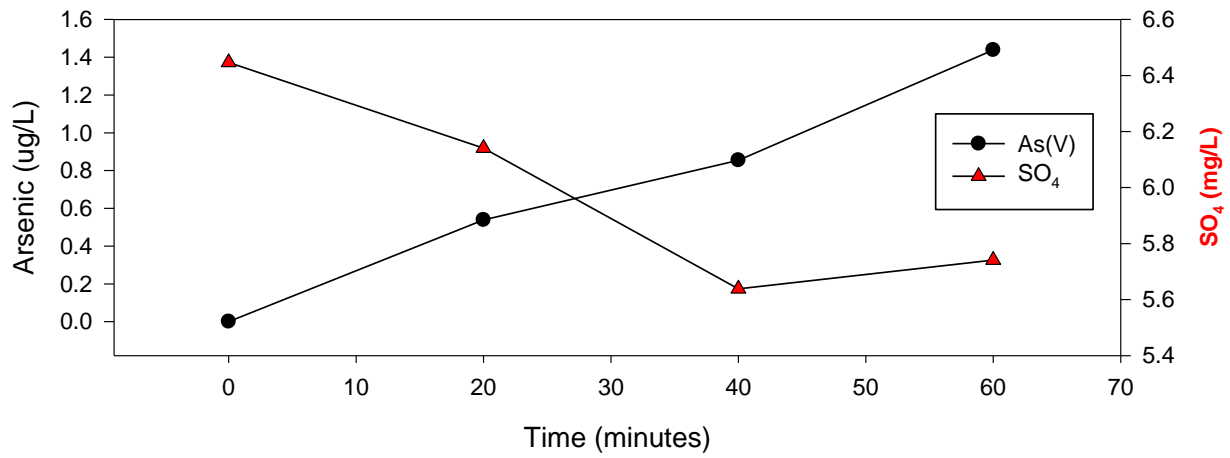

Location L5 Dynamics: Arsenic(V) & Sulfate (Test 2)

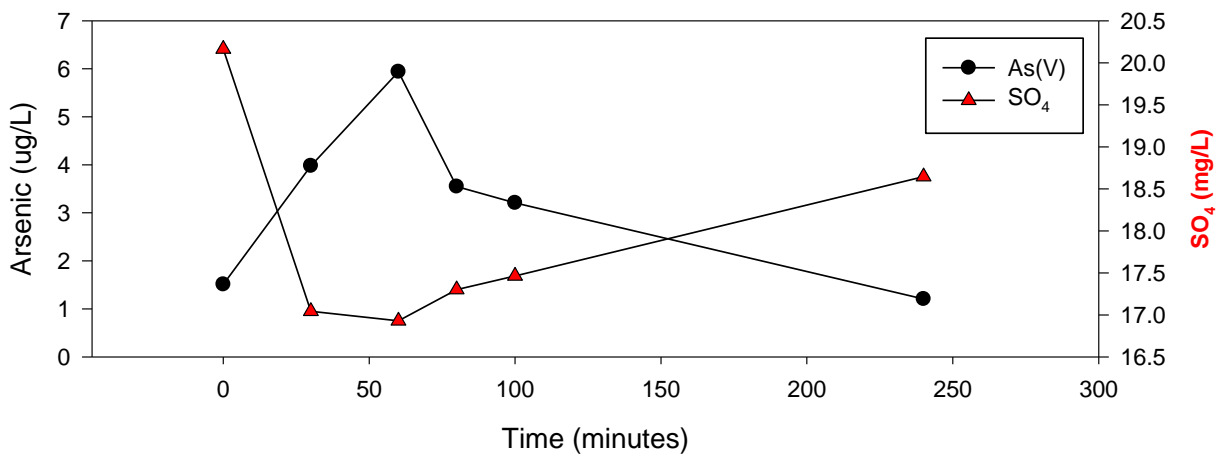

Location L5 Dynamics: Arsenic(V) & Sulfate (Test 3)

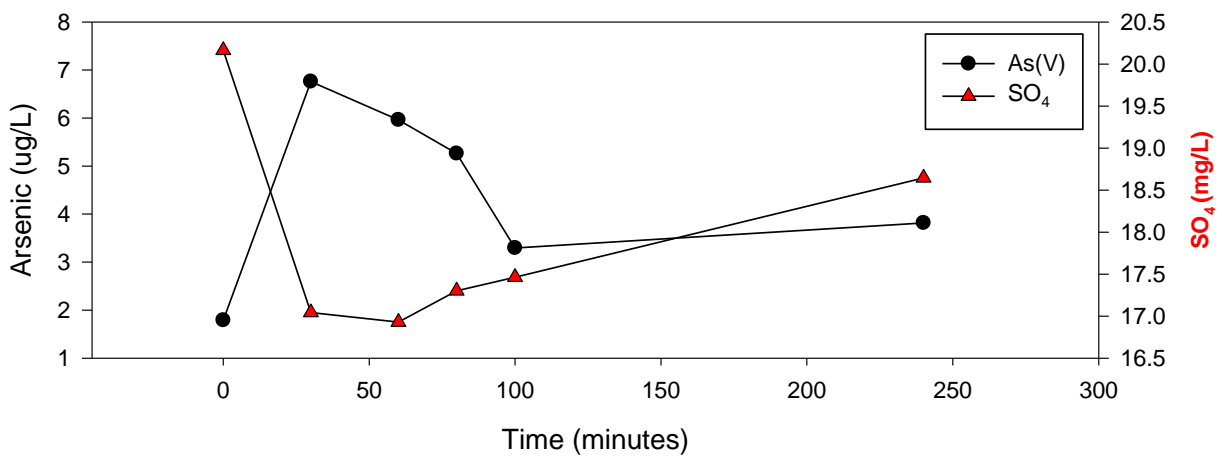

### Location L5 Pump Test: % Arsenic(V)

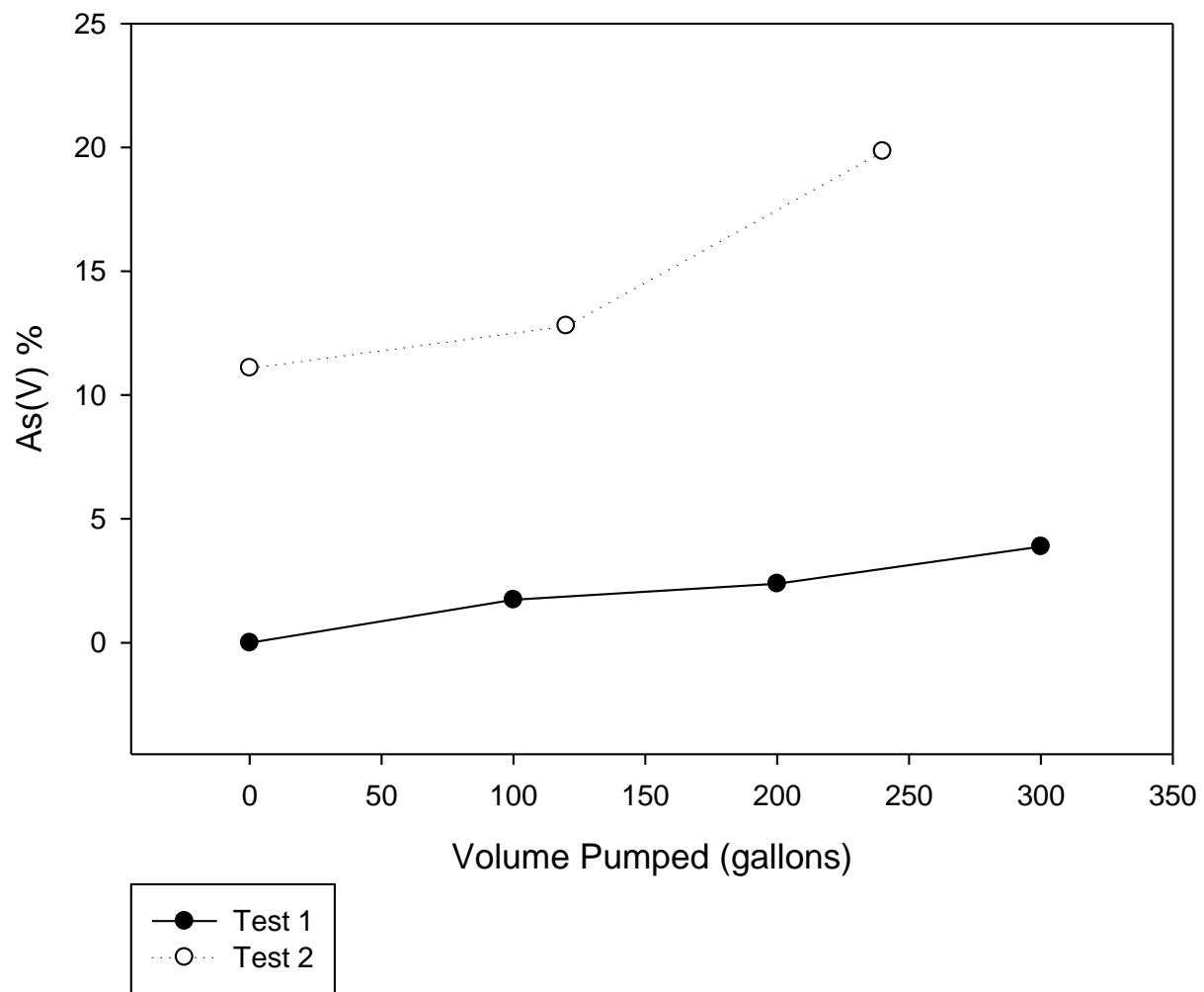

Location L5 Dynamics: Time vs Fe<sup>3+</sup>

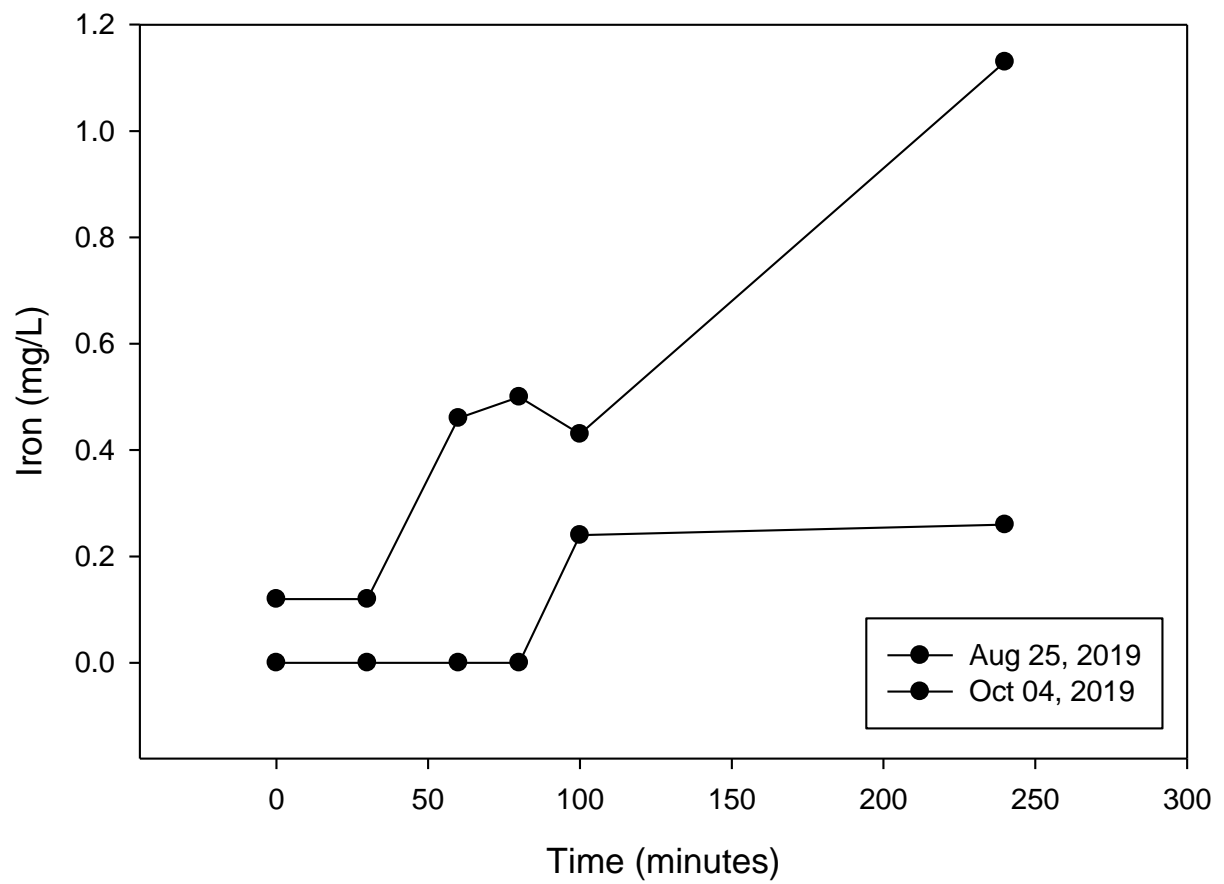

### Seasonal Arsenic: Location L6

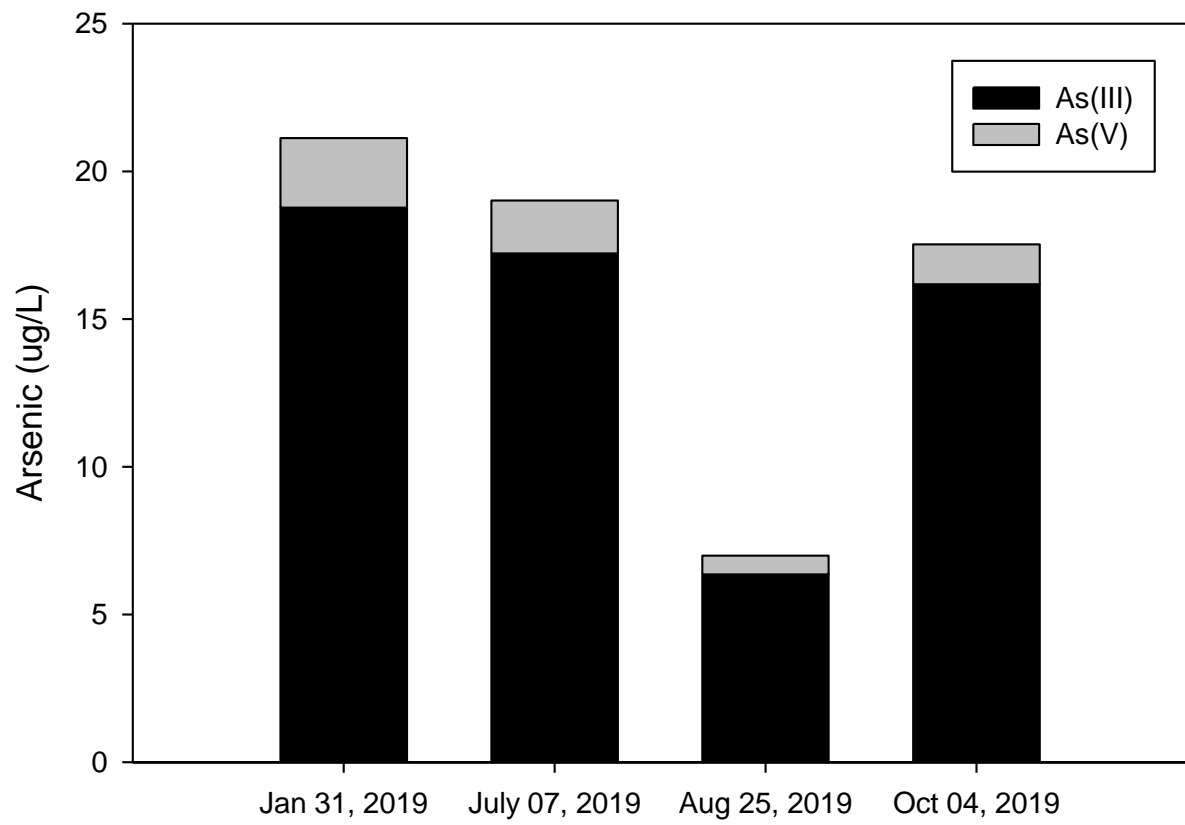

### Location L6 Dynamics: As & ORP

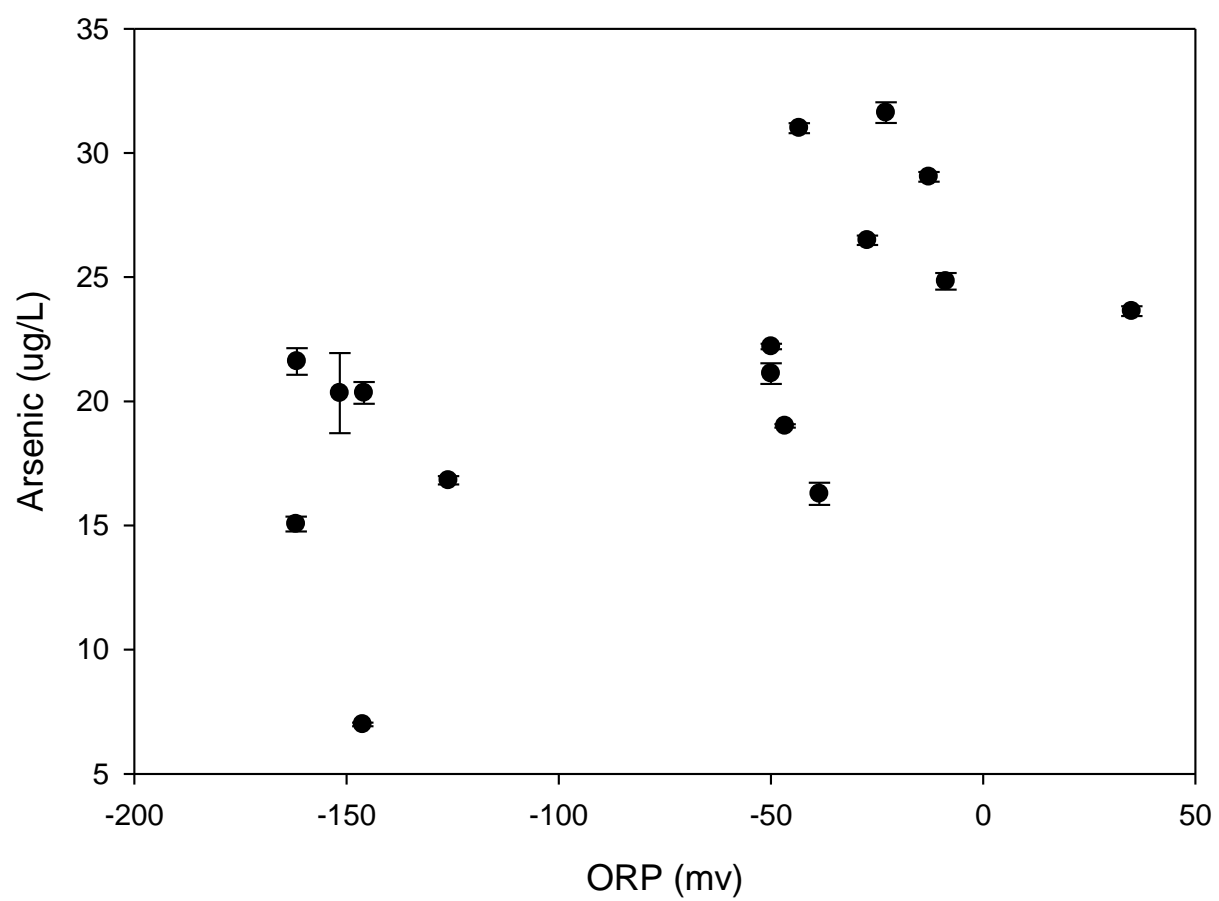

### Location L6 Dynamics: Arsenic & Sulfate

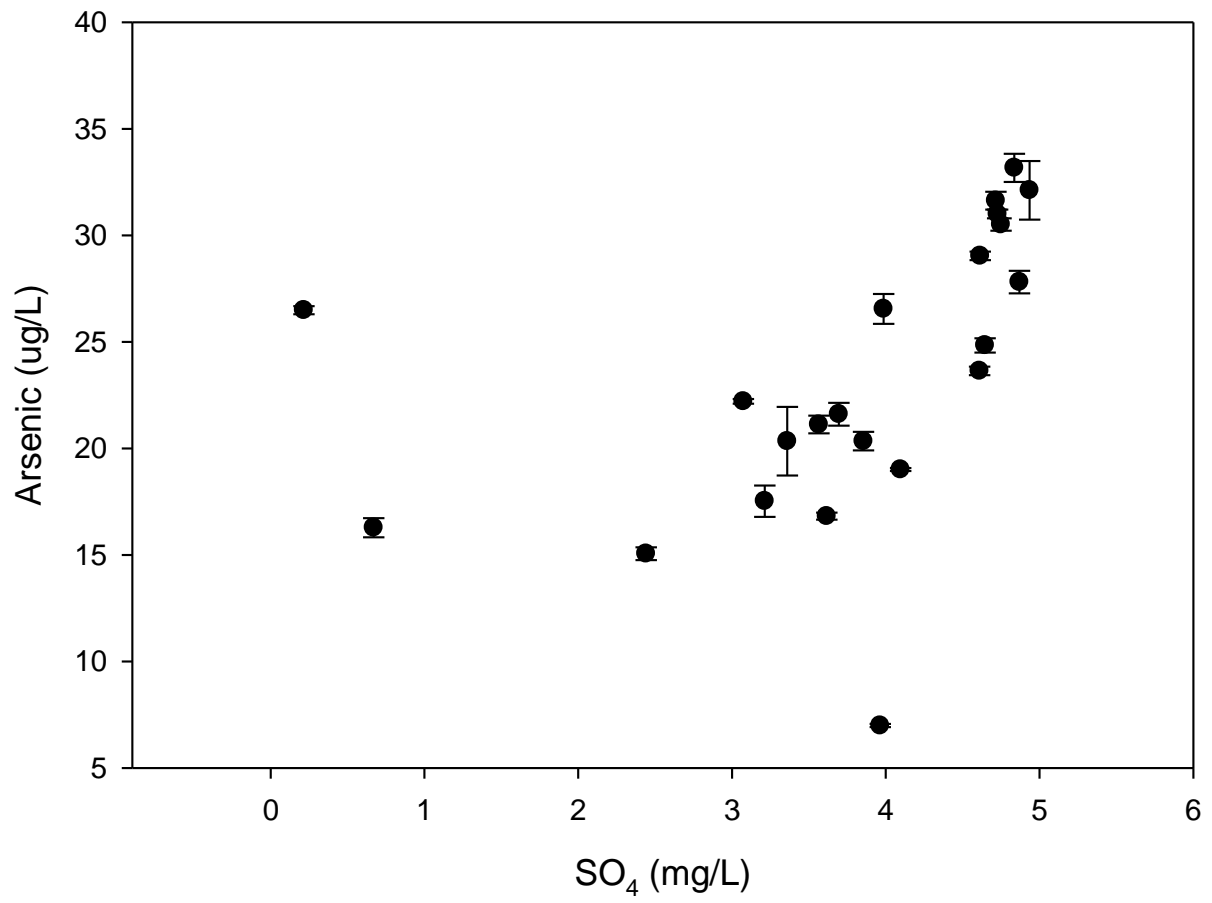

### Location L6 Dynamics: As(V) & ORP

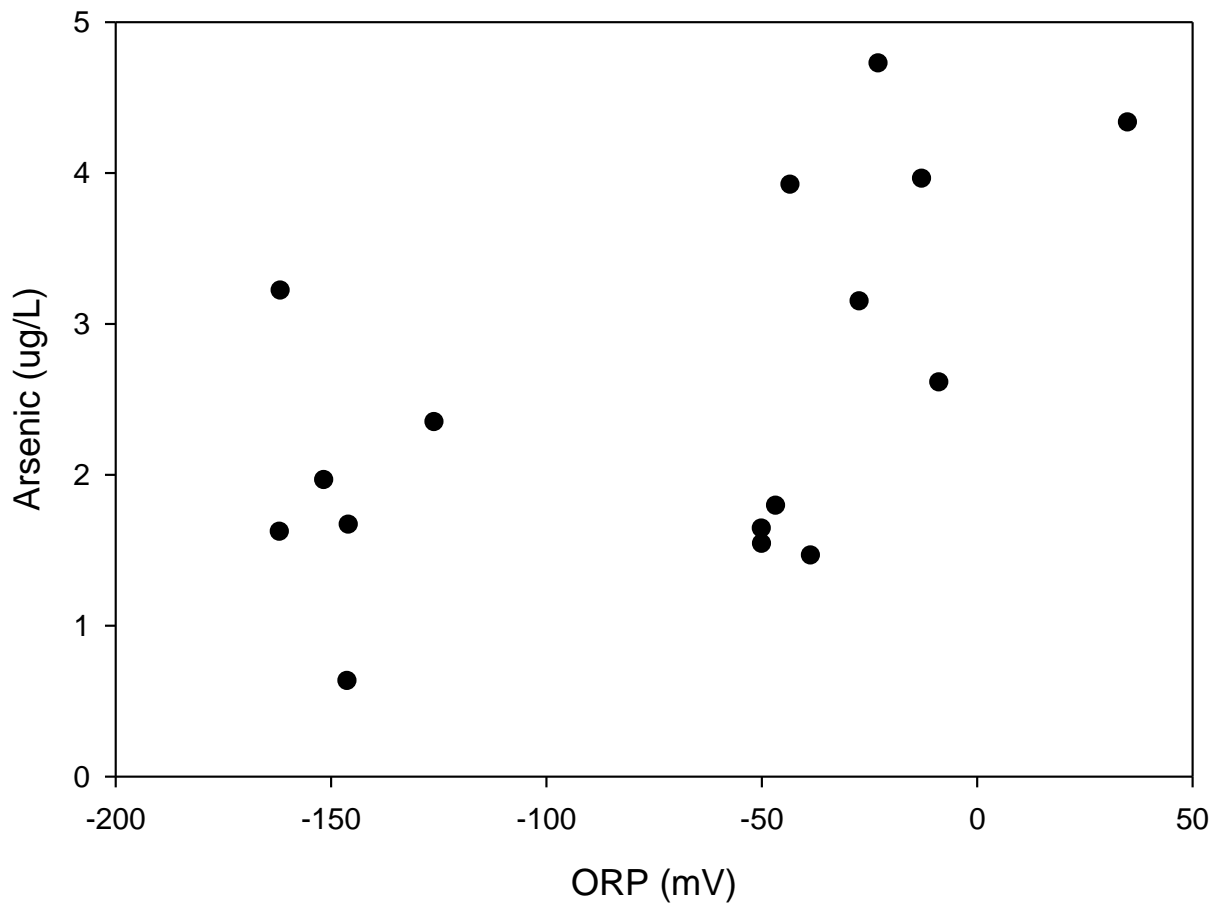

### Seasonal Arsenic: Location L9

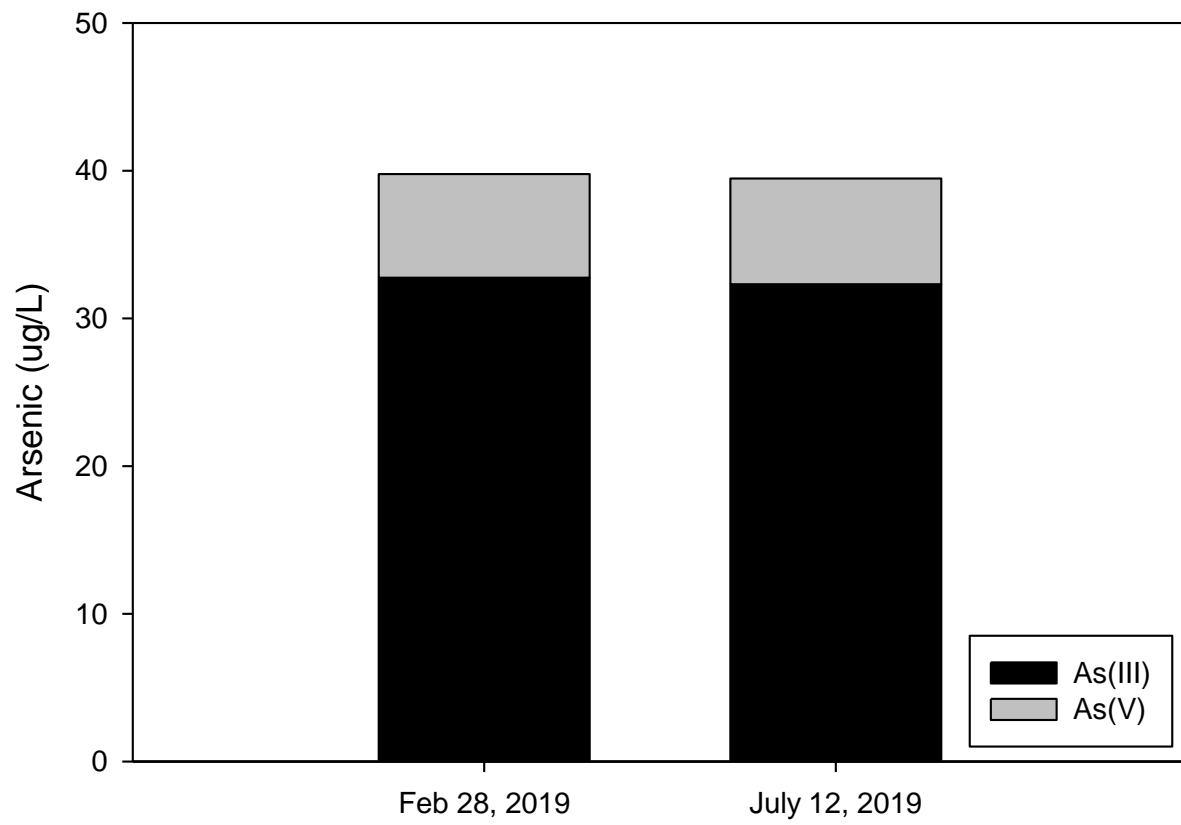

### Seasonal Arsenic: Location L15

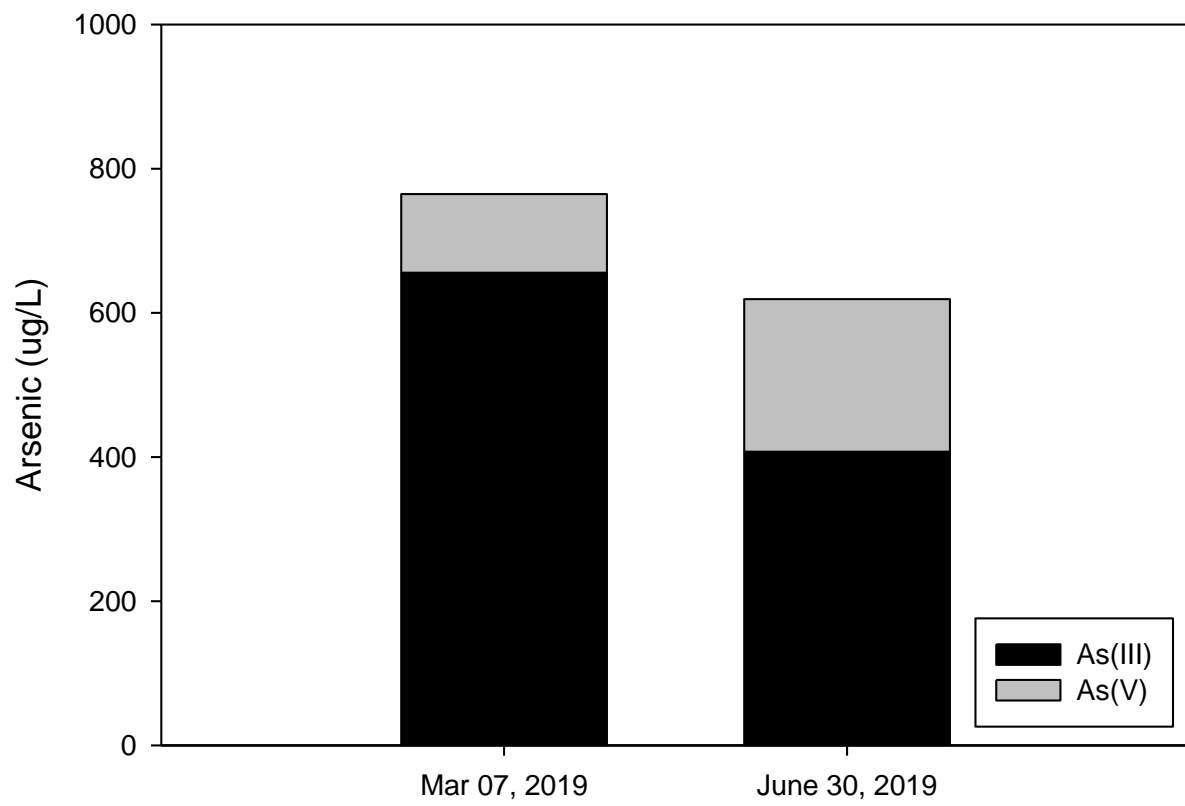

### Location L15 Dynamics: Arsenic & Sulfate

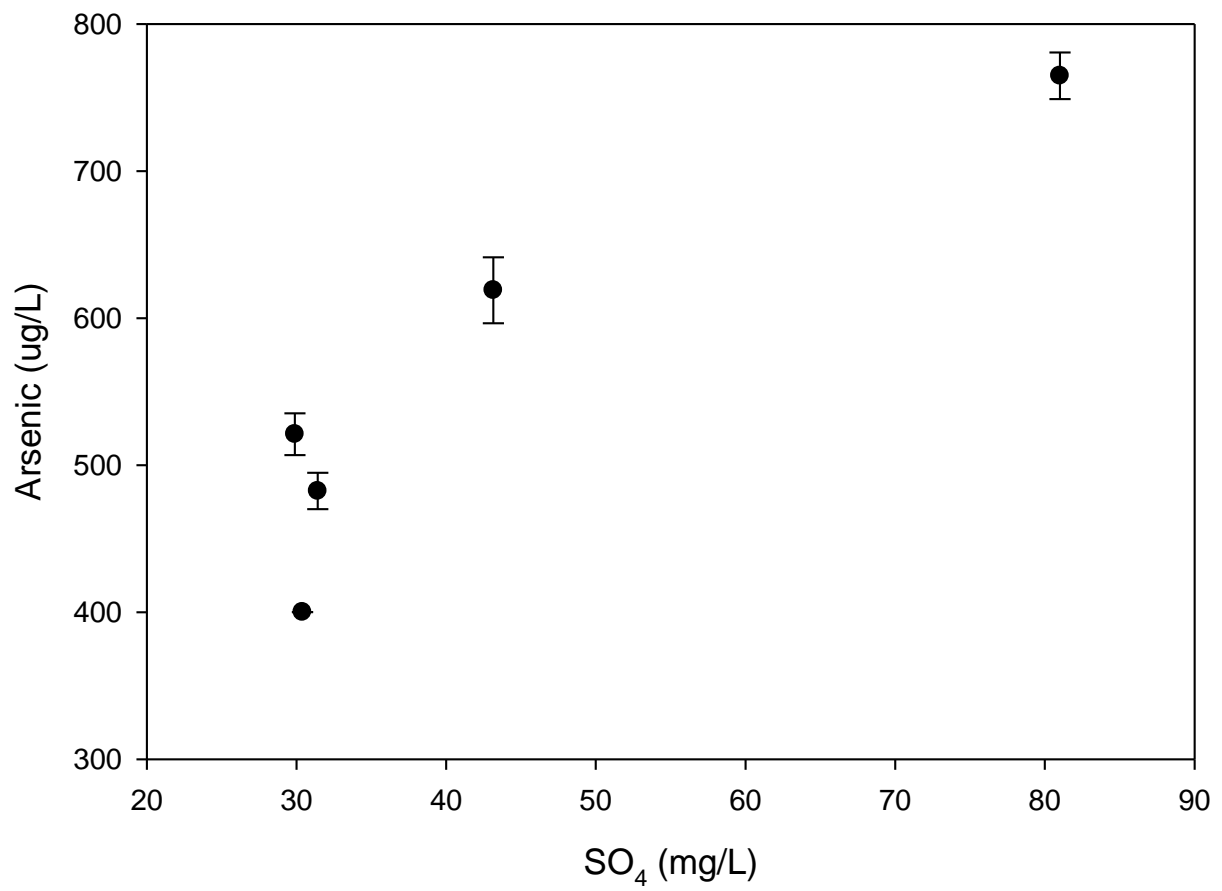

### Location L15 Pump Test: % As(V)

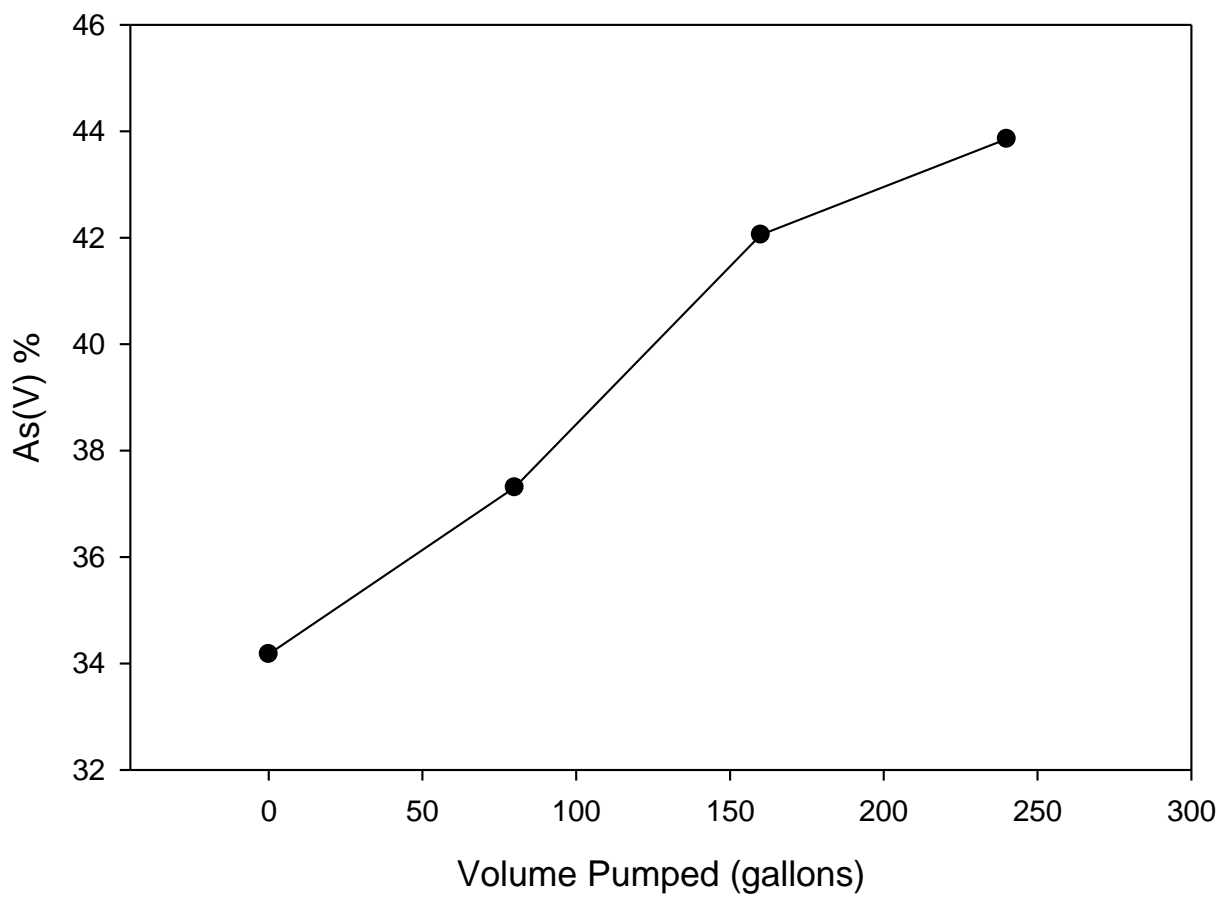

### Seasonal Arsenic: Location L16

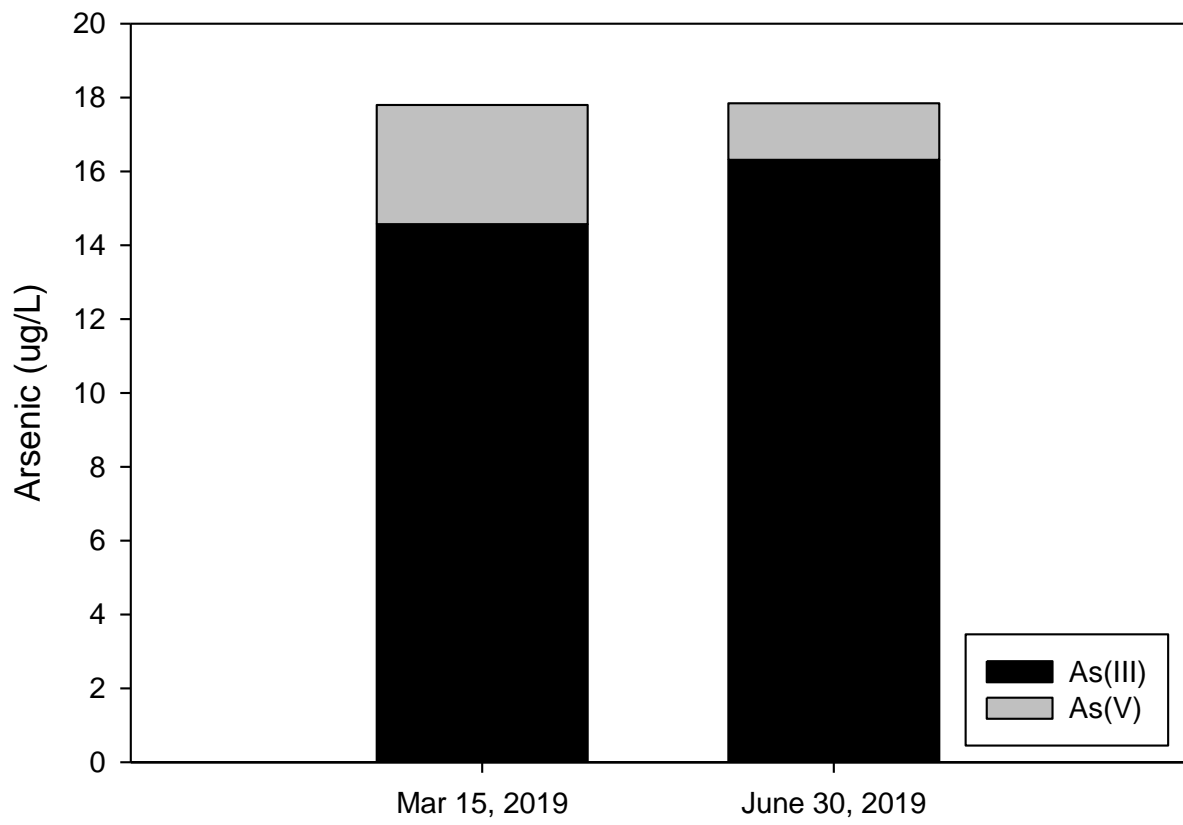

### Location L16 Dynamics: Sulfate vs Arsenic

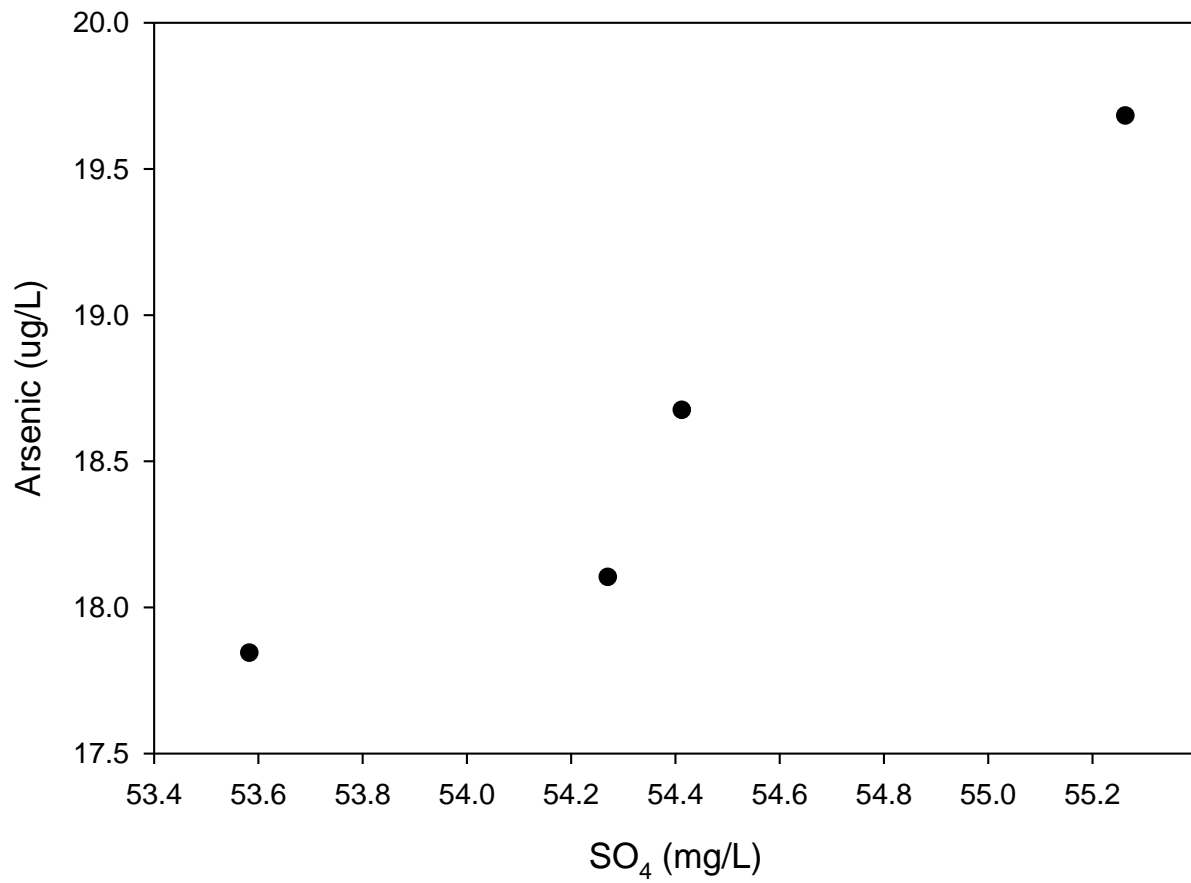

### Seasonal Arsenic: Location L18

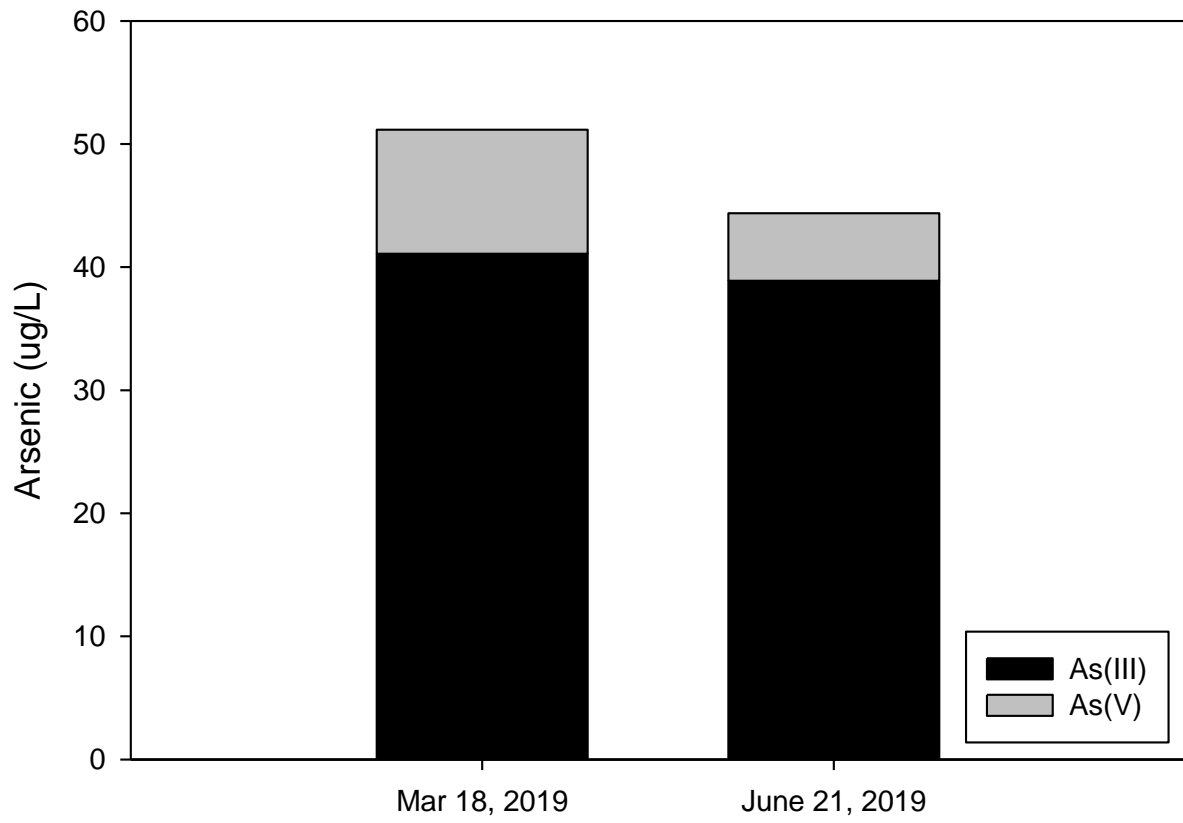

### Location L18 Pump Test: % As(V)

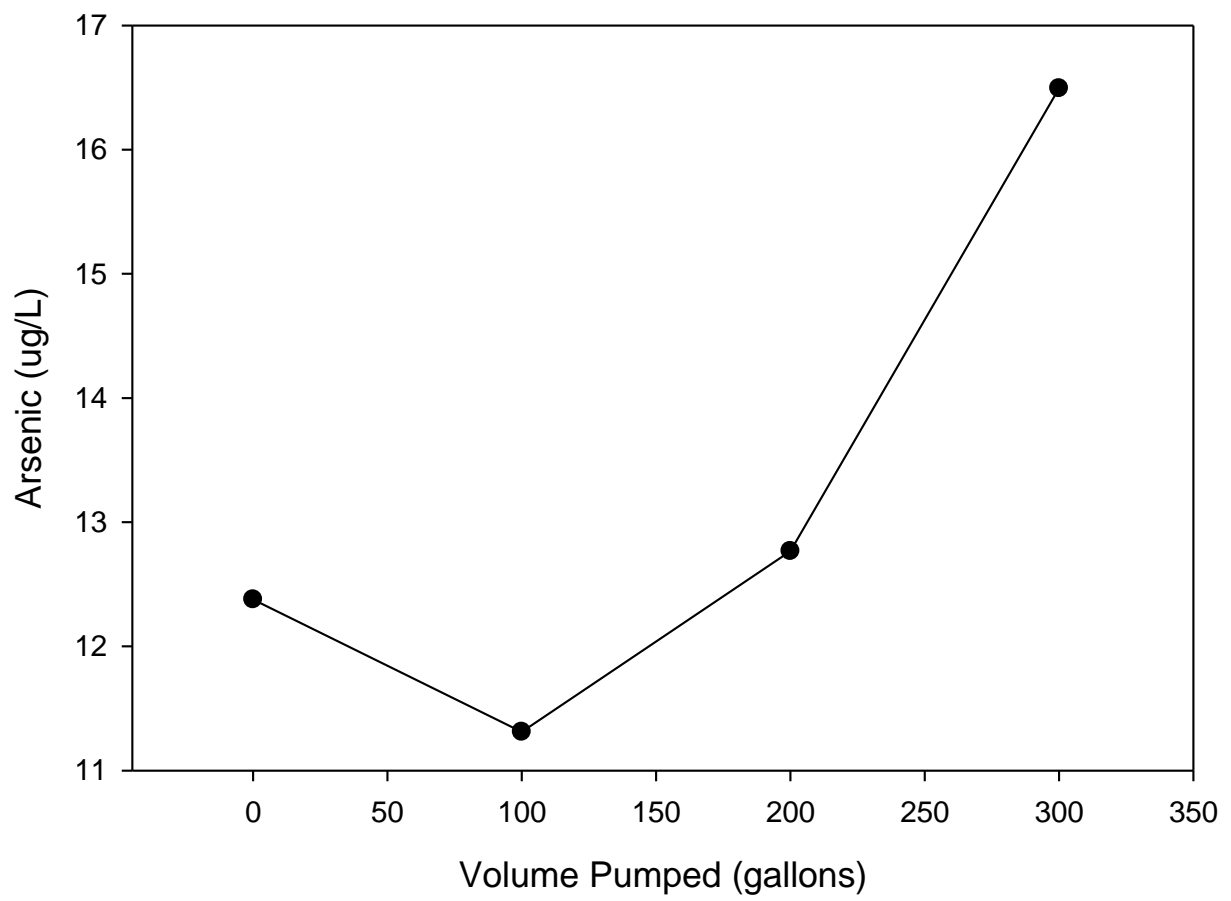

### Seasonal Arsenic: Location L13

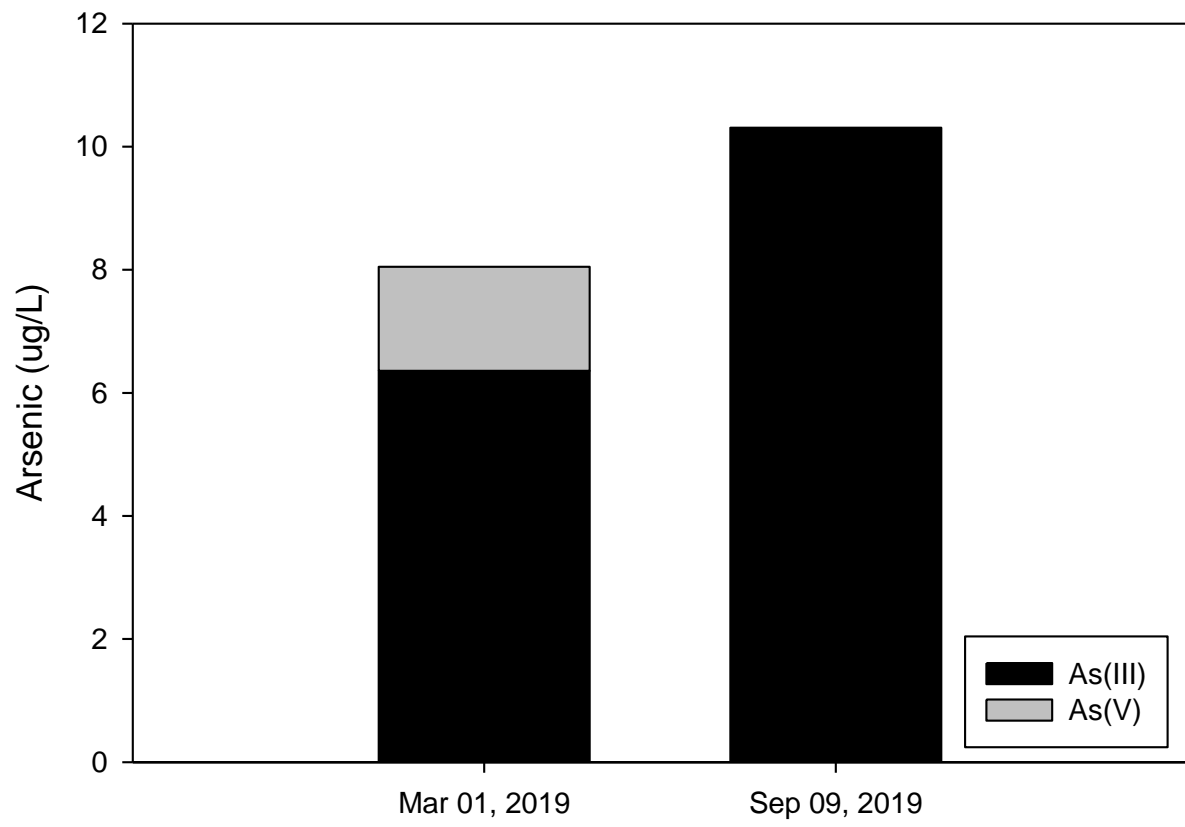

### Seasonal Arsenic: Location L14

